

# **can-am**®



Side-by-Side Product Spec Book

2024

Vehicle Specifications, Accessories and Parts & Maintenance



# TABLE OF CONTENTS

## CAN-AM DEFENDER

|                   |    |
|-------------------|----|
| Featured Packages | 8  |
| Comparative Chart | 14 |
| Accessories       | 25 |

## CAN-AM MAVERICK X3

|                   |    |
|-------------------|----|
| Featured Packages | 72 |
| Comparative Chart | 80 |
| Accessories       | 85 |

## CAN-AM MAVERICK R

|                   |     |
|-------------------|-----|
| Featured Packages | 124 |
| Comparative Chart | 132 |
| Accessories       | 133 |

## CAN-AM COMMANDER, MAVERICK TRAIL & MAVERICK SPORT

|  |     |
|--|-----|
| Commander Featured Packages                          | 160 |
| Commander Comparative Chart                          | 166 |
| Maverick Trail Featured Package                      | 170 |
| Maverick Trail & Maverick Sport<br>Comparative Chart | 172 |
| Accessories  | 175 |

## PARTS AND MAINTENANCE

|                             |     |
|-----------------------------|-----|
| Keep an Eye on These Parts  | 220 |
| Genuine Parts               | 224 |
| Tires & Rims                | 228 |
| Maintenance & Care Products | 234 |

## CAN-AM OFFROAD.COM

© 2023 Bombardier Recreational Products Inc. (BRP). All rights reserved. ®, TM and the BRP logo are trademarks of BRP or its affiliates. In the USA, products are distributed by BRP US Inc. All other trademarks are the property of their respective owners. BRP reserves the right to discontinue or change specifications, prices, designs, features, models or equipment without incurring obligation. Some models shown may include optional equipment. Product performance may vary depending on external factors. BRP recommends that all SxS drivers take a training course. See your dealer. SxS can be hazardous to operate. Never exceed the SxS's passenger capacity. All SxS models are meant to be used by drivers aged 16 and older. Read the operator's guide. Follow all instructional and safety material and observe applicable laws and regulations. SxS are for off-road use only; never ride on paved surfaces or public roads. For your safety, the operator and passenger(s) must wear a helmet, eye protection and applicable protective clothing. Always remember that riding and alcohol/drugs don't mix. Never engage in stunt driving. Avoid excessive speed and be particularly careful on difficult terrain. Always ride responsibly and safely. See your authorized BRP dealer for details and visit <https://can-am-brp.com/>. Printed in Canada.







# If We Sell It, We Stand by It.

---

## BRP Limited Warranty\*

for new Parts, Accessories  
and Riding Gear

---

### 1-year limited warranty\*\*

- Genuine BRP Parts and Accessories installed by you or your authorized BRP dealer
- Aftermarket Products sold through BRP
- Riding Gear

### 4-year limited warranty\*\*

- Helmets

GET ALL THE DETAILS FROM  
YOUR CAN AM OFF ROAD DEALER

\*Purchased at an authorized BRP dealership/distributor or on a BRP-authorized online store. Other exclusions may apply; see complete limited warranty or contact your Can-Am Off Road authorized dealer. This limited warranty does not apply to factory-installed accessories and Evinrude parts and accessories.

\*\*Unless otherwise stipulated or required by law.





# CUSTOMIZING MADE EASY

1

Select the model.

2

Select the package.

3

Customize color, engine, and accessories (or accessory bundles) for your vehicle.

4

Click "Save" or "Send to dealer."



If you can dream it, you can build it. And ride it. Creating a Can-Am vehicle tailored made for our riders' needs has never been easier. Scan the QR code and follow the step-by-step above.

**BUILD  
YOUR NOW**





**CAN-AM DEFENDER**



# CAN-AM DEFENDER

## FEATURED PACKAGES

|                            |    |
|----------------------------|----|
| 2024 DefenderXT HD 7/HD 9  | 8  |
| 2024 DefenderDPS HD 7/HD 9 | 10 |
| 2024 DefenderM AX Limited  | 12 |

## COMPARATIVE CHART

## ACCESSORIES

|                               |    |
|-------------------------------|----|
| Roofs                         | 27 |
| Cabs                          | 28 |
| Windshields & Mirrors         | 29 |
| Rear Wind Protection          | 31 |
| Doors                         | 32 |
| Seat Accessories              | 34 |
| Aluminum Skid Plates          | 35 |
| Bumpers & Guards              | 36 |
| LinQ :Easy On, Easy Off Cargo | 39 |
| Cargo & Storage               | 44 |
| Racks & Holders               | 47 |
| Lights                        | 50 |
| Audio & Communication Systems | 53 |
| Electronic Accessories        | 54 |
| Winches & Hitches             | 56 |
| Performance                   | 59 |
| Apache Track Systems          | 61 |
| ProMountPlows                 | 64 |
| Covers & Add-Ons              | 68 |









# 2024 DEFENDER XT HD7 / HD9



| ENGINES              | HD7  | HD9  |
|----------------------|--|--|
| Type                 | 52 hp / 42 lb-ft, Rotax® ACE (Advanced Combustion Efficiency) 650 cc single cylinder, liquid-cooled                                  | 65 hp / 59 lb-ft, Rotax® 976 cc, V-twin, liquid-cooled                                       |
| Fuel Delivery System | Intelligent Throttle Control (iTC™) with Electronic Fuel Injection (EFI)   |  |
| Transmission         | PRO-TORQ CVT with Quick Response System (QRS), high-airflow ventilation and Electronic Drive Belt Protection Extra-L / H / N / R / P |  |
| Drive Train          | Selectable Turf Mode / 2WD / 4WD with Visco-Lok <sup>†</sup> QE auto-locking front differential                                      | Selectable Turf Mode / 2WD / 4WD with Visco-Lok <sup>†</sup> auto-locking front differential |
| Driving Assistance   | Electronic Hill Descent Control ECO™ / ECO™ Off / Work modes   |  |
| Power Steering       | Dynamic Power Steering (DPS™)  |  |

## SUSPENSIONS

|                  |   |
|------------------|---|
| Front Suspension | Double A-arm / 10 in. (25.4 cm) suspension travel               |
| Front Shocks     | Twin tube gas-charged shocks                                    |
| Rear Suspension  | TTA with external sway bar / 10 in. (25.4 cm) suspension travel |
| Rear Shocks      | Twin tube gas-charged shocks                                    |

## TIRES & WHEELS

|                    |                                      |
|--------------------|--------------------------------------|
| Front / Rear Tires | XPS Trail Force 27 x 9 / 11 x 14 in. |
| Wheels             | 14 in. cast aluminum                 |

## BRAKES

|       |   |
|-------|---|
| Front | Dual 220 mm disc brakes with hydraulic twin-piston calipers   |
| Rear  | Dual 220 mm disc brakes with hydraulic single-piston calipers |
|       | Brake holding mechanism                                       |

## PACKAGE HIGHLIGHTS

- Brake holding mechanism
- VERSA-PRO bolster bench seat with reinforced XT seat skin and adjustable driver seat
- 4,500 lb (2,014 kg) winch
- XT front bumper
- Full hard roof
- HMWPE full skid plate

## DIMENSIONS & CAPACITIES

|                        | HD7  | HD9                 |
|------------------------|--|---------------------|
| Cage                   | Profiled cage, ROPS approved                           |                     |
| Estimated Dry Weight   | 1,577 lb (717 kg)                                      | 1,606 lb (728.5 kg) |
| L x W x H              | 125.7 x 62 x 78 in. (319.4 x 157.5 x 198.1 cm)         |                     |
| Wheelbase              | 83 in. (211.5 cm)                                      |                     |
| Ground Clearance       | 11 in. (28 cm)   |                     |
| Cargo Box Dimensions   | 38 x 54.5 x 12 in. (96.5 x 138.4 x 30.5 cm)            |                     |
| Cargo Box Capacity     | 1,000 lb (454 kg) / California only: 600 lb (272.2 kg) |                     |
| Power Tilt Bed         | N/A  |                     |
| Tailgate Load Capacity | 250 lb (113.4 kg)                                      |                     |
| Storage Capacity       | Total: 16.2 gal (61.3 L)                               |                     |
| Towing Capacity        | 2,500 lb (1,134 kg)                                    |                     |
| Payload Capacity       | 1,500 lb (680 kg)                                      |                     |
| Fuel Capacity          | 10.6 gal (40 L)  |                     |
| Person Capacity        | 3  |                     |

## FEATURES

|                 |  |
|-----------------|--|
| Gauge           | 4.5 in. wide digital display   |
| Battery         | 12 V (30 amp/h)  |
| Magneto         | 650 W  |
| Instrumentation | DC outlet (10 A)<br>USB port (10 A) x 2  |
| Lighting        | Front lighting output 140 W<br>LED tail lights   |
| Winch           | 4,500 lb (2,041 kg) winch with roller fairlead   |
| Seat            | VERSA-PRO bolster bench seats with passenger seats flipping up<br>Adjustable driver seat, underside hooks, reinforced XT seat skin |
| Steering Wheel  | Adjustable tilt steering   |
| Protection      | XT front bumper<br>HMWPE full skid plate<br>Full hard roof   |
| Hitch Type      | 2 in. hitch receiver   |

## WARRANTY & EXTENDED SERVICE

|                  |   |
|------------------|---|
| Factory Warranty | 1 year BRP limited warranty             |
| Extended Service | B.E.S.T. term available up to 30 months |
| Terms            |   |

<sup>†</sup> Visco-Lok is a trademark of GKN ViscoDrive GmbH.  
All other trademarks are the property of their respective owners.





 Wildland Camo

## Feature highlights



### Need a Break?

Whether you're going on sloped terrain or hauling heavy loads, you know you're in good hands riding a Can-Am Defender XT. This workhorse comes equipped with a brake holding mechanism; this feature maintains constant pressure on the brake pedal when needed to keep the vehicle from moving and give you peace of mind.



### VERSA is for Versatile

Work hard, rest harder. The Can-Am Defender XT takes that motto to heart with the ultra-comfortable VERSA-PRO bench seat. Get in and out of your workhorse in no time to focus on the task at hand. That's the best way to make the long days of hard work flash by!



### Power Out of a Jam

The 4,500-lb (2,041 kg) integrated winch with roller fairlead engages with the flick of a switch to dominate the most difficult tasks. Effective for vehicle recovery, hunting trips, clearing brush, and at the job site. It's one of the most powerful tools built into the Defender XT.



### More Bumps? No Problem!

At the front of this side-by-side sits a dependable and sturdy XT front bumper. Protecting the front of your vehicle, this bumper clears the way with enhanced protection from the obstacles you drive across.



### Not Just a Roof!

Over your head in the Can-Am Defender XT is a full hard roof that gives you better protection from the elements. Keep sunlight, rain or snow away when getting tasks done.

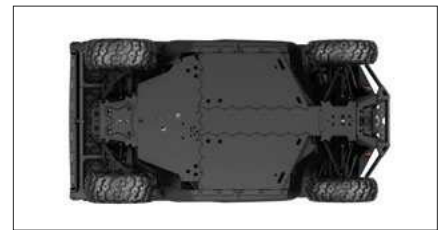

### Protection Wherever You Go

This model sports a High Molecular Weight Polyethylene (HMWPE) full skid plate for full protection under the unit. No matter the terrain or weather, you can keep riding and working with confidence knowing that the Can-Am Defender XT will glide smoothly over obstacles of all sizes.



# 2024 DEFENDER DPS HD7 / HD9



- Tundra Green / HD7 / HD9
- Timeless Black / HD9
- Fiery Red / HD9
- Wildland Camo / HD7 / HD9

| ENGINES                   | HD7   | HD9  |
|---------------------------|---|--|
| Type                      | 52 hp / 42 lb-ft, Rotax® ACE (Advanced Combustion Efficiency) 650 cc single cylinder, liquid-cooled | 65 hp / 59 lb-ft, Rotax® 976 cc, V-twin, liquid-cooled   |
| Fuel Delivery System      | Intelligent Throttle Control (ITC™) with Electronic Fuel Injection (EFI)                            |  |
| Transmission              | pDrive primary CVT with engine braking and Electronic Drive Belt Protection L / H / N / R / P       | PRO-TORQ CVT with Quick Response System (QRS), high-airflow ventilation and Electronic Drive Belt Protection Extra-L / H / N / R / P |
| Drive Train               | Selectable Turf Mode / 2WD / 4WD with Visco-Lok <sup>1</sup> QE auto-locking front differential     | Selectable Turf Mode / 2WD / 4WD with Visco-Lok <sup>1</sup> auto-locking front differential   |
| Driving Assistance        | Electronic Hill Descent Control ECO™ / ECO™ Off / Work modes  |  |
| Power Steering            | Dynamic Power Steering (DPS™)   |  |
| <b>SUSPENSIONS</b>        |   |  |
| Front Suspension          | Double A-arm / 10 in. (25.4 cm) suspension travel   |  |
| Front Shocks              | Twin tube gas-charged shocks  |  |
| Rear Suspension           | TTA with external sway bar / 10 in. (25.4 cm) suspension travel                                     |  |
| Rear Shocks               | Twin tube gas-charged shocks  |  |
| <b>TIRES &amp; WHEELS</b> |   |  |
| Front / Rear Tires        | XPS Trail Force 27 x 9 / 11 x 14 in.  |  |
| Wheels                    | 14 in. cast aluminum  |  |
| <b>BRAKES</b>             |   |  |
| Front                     | Dual 220 mm disc brakes with hydraulic twin-piston calipers   |  |
| Rear                      | Dual 220 mm disc brakes with hydraulic single-piston calipers                                       |  |

## PACKAGE HIGHLIGHTS

- Dynamic Power Steering (DPS™)
- 14 in. cast-aluminum wheels

## DIMENSIONS & CAPACITIES

|                        | HD7  | HD9               |
|------------------------|--|-------------------|
| Cage                   | Profiled cage, ROPS approved                           |                   |
| Estimated Dry Weight   | 1,471 lb (667 kg)                                      | 1,541 lb (699 kg) |
| L x W x H              | 121 x 62 x 76 in. (307.1 x 157.5 x 193 cm)             |                   |
| Wheelbase              | 83 in. (211.5 cm)                                      |                   |
| Ground Clearance       | 11 in. (28 cm)   |                   |
| Cargo Box Dimensions   | 38 x 54.5 x 12 in. (96.5 x 138.4 x 30.5 cm)            |                   |
| Cargo Box Capacity     | 1,000 lb (454 kg) / California only: 600 lb (272.2 kg) |                   |
| Power Tilt Bed         | N/A  |                   |
| Tailgate Load Capacity | 250 lb (113.4 kg)                                      |                   |
| Storage Capacity       | Total: 10.4 gal (39.5 L)                               |                   |
| Towing Capacity        | 2,500 lb (1,134 kg)                                    |                   |
| Payload Capacity       | 1,500 lb (680 kg)                                      |                   |
| Fuel Capacity          | 10.6 gal (40 L)  |                   |
| Person Capacity        | 3  |                   |

## FEATURES

|                 |  |
|-----------------|--|
| Gauge           | 4.5 in. wide digital display   |
| Battery         | 12 V (18 amp/h)  |
| Magneto         | 650 W  |
| Instrumentation | DC outlet (10 A)   |
| Lighting        | Front lighting output 140 W<br>LED tail lights                           |
| Winch           | N/A  |
| Seat            | VERSA-PRO bench seat with passenger seats flipping up<br>Underside hooks |
| Steering Wheel  | Adjustable tilt steering   |
| Protection      | Integrated front steel bumper<br>HMWPE central skid plate                |
| Hitch Type      | 2 in. hitch receiver   |

## WARRANTY & EXTENDED SERVICE

|                        |   |
|------------------------|---|
| Factory Warranty       | 1 year BRP limited warranty             |
| Extended Service Terms | B.E.S.T. term available up to 30 months |

<sup>1</sup> Visco-Lok is a trademark of GKN ViscoDrive GmbH.  
All other trademarks are the property of their respective owners.





 Withland Cam o

## Feature highlights



### Steering Clear of Issues

The Can-Am Defender DPS comes with Dynamic Power Steering (DPS). This high-torque technology is the stabilizing force you need to own every challenge: it's useful against external forces like strong crosswinds or uneven roads. With DPS, you ride confidently knowing you'll never veer off path.



### Rugged Aluminum Wheels

To keep things rolling, the Can-Am Defender DPS needs the right wheels. It's definitely the case with this workhorse. Sitting on 14 in. cast-aluminum wheels, the side-by-side is up for the task in any condition.



# 2024 DEFENDER MAX LIMITED

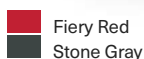

Fiery Red

Stone Gray



Desert Tan & Timeless Black

Wildland Camo

| ENGINE               | HD10   |
|----------------------|--|
| Type                 | 82 hp / 69 lb-ft, Rotax® 976 cc, V-twin, liquid-cooled   |
| Fuel Delivery System | Intelligent Throttle Control (ITC™) with Electronic Fuel Injection (EFI)   |
| Transmission         | PRO-TORQ CVT with Quick Response System (QRS), high-airflow ventilation and Electronic Drive Belt Protection Extra-L / H / N / R / P |
| Drive Train          | Selectable Turf Mode / 2WD / 4WD with exclusive Smart-Lok*   |
| Driving Assistance   | Electronic Hill Descent Control ECO™ / ECO™ Off / Work modes   |
| Power Steering       | Dynamic Power Steering (DPS™)  |
| SUSPENSIONS          |  |
| Front Suspension     | Arched double A-arm with sway bar / 12 in. (30.5 cm) suspension travel   |
| Front Shocks         | Twin tube gas-charged shocks   |
| Rear Suspension      | Arched TTA with external sway bar / 12 in. (30.5 cm) suspension travel   |
| Rear Shocks          | Twin tube gas-charged shocks   |
| TIRES & WHEELS       |  |
| Front / Rear Tires   | XPS Trac Force 30 x 9 / 10 x 14 in.  |
| Wheels               | 14 in. cast aluminum   |
| BRAKES               |  |
| Front                | Dual 220 mm disc brakes with hydraulic twin-piston calipers  |
| Rear                 | Dual 220 mm disc brakes with hydraulic twin-piston calipers<br>Brake holding mechanism   |

## PACKAGE HIGHLIGHTS

- Auto heating and air conditioning (HVAC) climate system
- Full hard roof with liner and interior dome light
- Full color-match doors with electric opening windows in front
- 3-position full glass tilt-up windshield with wiper / washer kit
- Rear glass window
- Brake holding mechanism
- Panoramic mirror
- VERSA-PRO bolster bench seat with reinforced Limited seat skin and adjustable driver seat
- 7.6 in. digital display with keypad
- 65 in. wide with arched A-arm
- LED signature
- 30 in. XPS Trac Force tires
- 4,500 lb (2,014 kg) winch
- XT front bumper
- HMWPE full skid plate

## DIMENSIONS & CAPACITIES

|                        |  |
|------------------------|--|
| Cage                   | Profiled cage, ROPS approved                           |
| Estimated Dry Weight   | 2,466 lb (1,119 kg)                                    |
| L x W x H              | 158 x 65 x 81 in. (402 x 165.1 x 226 cm)               |
| Wheelbase              | 115.5 in. (294 cm)                                     |
| Ground Clearance       | 14 in. (35.6 cm)                                       |
| Cargo Box Dimensions   | 38 x 54.5 x 12 in. (96.5 x 138.4 x 30.5 cm)            |
| Cargo Box Capacity     | 1,000 lb (454 kg) / California only: 600 lb (272.2 kg) |
| Power Tilt Bed         | N/A  |
| Tailgate Load Capacity | 250 lb (113.4 kg)                                      |
| Storage Capacity       | Total: 12.7 gal (48.1 L)                               |
| Towing Capacity        | 2,500 lb (1,134 kg)                                    |
| Payload Capacity       | 1,225 lb ( 555 kg)                                     |
| Fuel Capacity          | 10.6 gal (40 L)  |
| Person Capacity        | 6  |

## FEATURES

|                 |   |
|-----------------|---|
| Gauge           | 7.6 in. wide digital display with keypad  |
| Battery         | 12 V (30 amp/h)   |
| Magneto         | 850 W   |
| Instrumentation | DC outlet (10 A)<br>USB port (10 A) x 2   |
| Lighting        | Front lighting output 140 W<br>LED signature<br>LED tail lights   |
| Winch           | 4,500 lb (2,041 kg) winch with roller fairlead  |
| Seat            | VERSA-PRO bolster bench seats with passenger seats flipping up<br>Adjustable driver seat, underside hooks, reinforced seat skin featuring Limited package trims   |
| Steering Wheel  | Adjustable tilt steering  |
| Protection      | XT front bumper<br>HMWPE full skid plate<br>Full hard roof with liner and interior dome light<br>Full color-match doors with electric opening windows in front<br>3-position full glass tilt-up windshield with wiper / washer kit<br>Rear glass window |
| Hitch Type      | 2 in. hitch receiver  |

## WARRANTY & EXTENDED SERVICE

|                  |   |
|------------------|---|
| Factory Warranty | 1 year BRP limited warranty             |
| Extended Service | B.E.S.T. term available up to 30 months |
| Terms            |   |

\*Smart-Lok was developed in conjunction with TEAM industries, a market leader in the drive train industry. All other trademarks are the property of their respective owners.





 Fiery Red

## Feature highlights



### Your HVAC Comfort Bubble

In the Can-Am Defender MAX Limited, you stay protected from the elements and can enjoy the perfect temperature regardless of the weather. That's the advantage of an HVAC (heating, venting & air conditioning) system with an industry-exclusive automatic mode and improved efficiency.



### Doors to Match Your Vehicle

The Can-Am Defender MAX Limited comes with Deluxe full-color match doors with FrontPower Windows. They deliver better visibility, sealing and premium design on every ride. Give your ride the edge it deserves with these sleek doors.



### Rugged XPS Tires

The Can-Am Defender MAX Limited has 30-inch XPS TracForce tires with a central tread that delivers good grip and comfort on compact terrain, the result is great responsiveness across any condition. Because the weather shouldn't get in the way of a ride, it should encourage one.



### Boost Your Comfort

The Can-Am Defender MAX Limited has enough comfort for everyone inside: the ultra comfortable VERSA-PRO bench seat makes it easier to get through those longer days of hard work. Even if you're never sitting more than 5 minutes at a time, get in and out of your workhorse easily and stay focused on the job. Seat also features Limited package trim and an adjustable driver's seat.



### Trip Info at Your Fingertips

Everything needed to control the perfect ride is on the Can-Am Defender MAX Limited's 7.6 inch dash-mounted digital display with keypad. At that size, it's readable in all conditions and puts all the vehicle's information and controls at the ready.



### A Signature Look

Ride with style in the Can-Am Defender MAX Limited courtesy of the LED signature lights. With these on, you deliver a more aggressive and biting look and light up the way with bright and energy-efficient LEDs.



### Tow Like a Pro

The Can-Am Defender MAX Limited has a 2,500 lb (1,134 kg) towing capacity. Behind a strong engine and powerful suspension, this workhorse gets it done in every riding condition. This must be what they call working with purpose.



### Protection Where It Counts

This model sports an XT front bumper and High Molecular Weight Polyethylene (HMWPE) full-skid plate. So no matter the terrain or weather, the Can-Am Defender MAX Limited is protected from the worst of it.





| DEFENDER***             |                        |                             |   |
|-------------------------|------------------------|---|---|
| COLOR OPTIONS           |                        | Tundra Green  | Tundra Green  |
| ENGINES                 | Type                   | HD 7<br>52 hp / 42 b-ft, Rotax® ACE (Advanced Combustion Efficiency)<br>650 cc single cylinder, liquid-cooled | HD 9<br>65 hp / 59 b-ft, Rotax® 976 cc, V-twin, liquid-cooled   |
|                         | Fuel Delivery System   | Intelligent Throttle Control (ITC™) with Electronic Fuel Injection (EFI)                                      |   |
|                         | Transmission           | 5-speed primary CVT with engine braking and Electronic Drive Belt Protection<br>L / H / N / R / P             | PRO-TORQ CVT with Quick Response System (QRS), high airflow ventilation and Electronic Drive Belt Protection<br>Extra-L / H / N / R / P |
|                         | Drive Train            | Selectable Turf Mode / 2WD / 4WD with Visco-Lok® auto-locking front differential                              |   |
|                         | Driving Assistance     | Electronic Hill Descent Control<br>ECO™ / ECO™ OFF / Work Modes   |   |
|                         | Power Steering         | N/A   |   |
|                         | SUSPENSIONS            | Front Suspension  | Double A-arm / 10 in. (25.4 cm) suspension travel   |
| Front Shocks            |                        | Tw in tube gas-charged shocks   |   |
| Rear Suspension         |                        | TTA with external sway bar / 10 in. (25.4 cm) suspension travel   |   |
| Rear Shocks             |                        | Tw in tube gas-charged shocks   |   |
| TIRES & WHEELS          | Front / Rear Tires     | XPS TrailForce 27 x 9 / 11 x 14 in.<br>14 in. steel   |   |
|                         | Wheels                 | 14 in. steel  |   |
| BRAKES                  | Front                  | Dual 220 mm disc brakes with hydraulic twin-piston calipers   |   |
|                         | Rear                   | Dual 220 mm disc brakes with hydraulic single-piston calipers   |   |
| DIMENSIONS & CAPACITIES | Cage                   | Profiled cage, ROPS approved  |   |
|                         | Estimated Dry Weight   | 1,456 lb (660 kg)   | 1,479 lb (671 kg)   |
|                         | L x W x H              | 121 x 62 x 76 in. (3071 x 1575 x 193 cm)  |   |
|                         | Wheelbase              | 83 in. (211.5 cm)   |   |
|                         | Ground Clearance       | 11 in. (28 cm)  |   |
|                         | Cargo Box Dimensions   | 38 x 54.5 x 12 in. (96.5 x 138.4 x 30.5 cm)   |   |
|                         | Cargo Box Capacity     | 1,000 lb (454 kg) / California only: 600 lb (272.2 kg)  |   |
|                         | Power Tilt Bed         | N/A   |   |
|                         | Tailgate Load Capacity | 250 lb (113.4 kg)   |   |
|                         | Storage Capacity       | Total: 3.1 gal (11.7 L)   |   |
|                         | Towing Capacity        | 2,500 lb (1,134 kg)   |   |
|                         | Payload Capacity       | 1,500 lb (680 kg)   |   |
|                         | Fuel Capacity          | 10.6 gal (40 L)   |   |
| Person Capacity         | 3                      |   |   |
| FEATURES                | Gauge                  | 4.5 in. wide digital display  |   |
|                         | Battery                | 12 V (8 amp/h)  |   |
|                         | Magneto                | 650 W   |   |
|                         | Instrumentation        | DC outlet (10 A)  |   |
|                         | Lighting               | Front lighting output 140 W<br>LED taillights   |   |
|                         | Winch                  | N/A   |   |
|                         | Seat                   | VERSA-PRO bench seat with passenger seats flipping up<br>Underseat hooks                                      |   |
|                         | Steering Wheel         | Adjustable tilt steering  |   |
|                         | Protection             | Integrated front steel bumper<br>HMWPE central skid plate   |   |
|                         | Hitch Type             | 2 in. hitch receiver  |   |

Visco-Lok is a trademark of GKN Viscotrive GmbH.

\*\*\*1-year BRP limited warranty, B.E.S.T. term available up to 30 months.





| DEFENDER                 |                              | DPS***  |   |   |
|--------------------------|------------------------------|---|---|---|
|                          |                              |                            |   |  |
| COLOR OPTIONS            |                              | Tundra Green<br>With Hilland Camo   | Tundra Green<br>Flare Red<br>Timelless Black<br>With Hilland Camo   | Tundra Green<br>Flare Red<br>Timelless Black  |
| ENGINES                  | Type                         | HD 7<br>52 hp / 42 b-ft, Rotax® ACE Advanced Combustion Efficiency<br>650 cc single cylinder, liquid-cooled | HD 9<br>65 hp / 59 b-ft, Rotax® 976 cc, V-twin, liquid-cooled   | HD 10<br>82 hp / 69 b-ft, Rotax® 976 cc, V-twin, liquid-cooled                      |
|                          | Fuel Delivery System         | Intelligent Throttle Control (ITC™)<br>with Electronic Fuel Injection (EFI)                                 |   |   |
|                          | Transmission                 | 5-speed primary CVT with engine braking<br>and Electronic Drive Belt Protection<br>L / H / N / R / P        | PRO-TORQ CVT with Quick Response System (QRS), high airflow ventilation and Electronic Drive Belt Protection<br>Extra-L / H / N / R / P |   |
|                          | Drive Train                  | Selectable Turf Mode / 2WD / 4WD with Visco-Lok® QE<br>auto-locking front differential                      | Selectable Turf Mode / 2WD / 4WD with Visco-Lok® auto-locking front differential  |   |
|                          | Driving Assistance           | Electronic Hill Descent Control<br>ECO™ / ECO™ Off / Work modes   |   |   |
|                          | Power Steering               | Dynamic Power Steering (DPS™)   |   |   |
|                          | SUSPENSIONS                  | Front Suspension  | Double A-arm / 10 in. (25.4 cm) suspension travel   |   |
| Front Shocks             |                              | Twin tube gas-charged shocks  |   |   |
| Rear Suspension          |                              | TTA with external swaybar / 10 in. (25.4 cm) suspension travel  |   | Arched TTA with external swaybar /<br>11 in. (27.9 cm) suspension travel            |
| Rear Shocks              |                              | Twin tube gas-charged shocks  |   |   |
| TIRES<br>WHEELS          | Front / Rear Tires<br>Wheels | XPS TrailForce 27 x 9 / 11 x 14 in.<br>14 in. cast-aluminum   |   | XPS TrailKing 27 x 9 / 11 x 14 in.<br>14 in. cast-aluminum                          |
|                          | BRAKES                       | Front   | Dual 220 mm disc brakes with hydraulic twin-piston calipers   |   |
| Rear                     |                              | Dual 220 mm disc brakes with hydraulic single-piston calipers   |   |   |
| DIMENSIONS<br>CAPACITIES | Cage                         | Profiled cage, ROPS approved  |   |   |
|                          | Estimated Dry Weight         | 1,471 lb (667 kg)   | 1,541 lb (699 kg)   | 1,558 lb (707 kg)   |
|                          | L x W x H                    | 121 x 62 x 76 in. (3071 x 1575 x 193 cm)  |   | 121 x 64 x 78 in. (3071 x 1625 x 1981 cm)   |
|                          | Wheelbase                    | 83 in. (211.5 cm)   |   |   |
|                          | Ground Clearance             | 11 in. (28 cm)  |   | 13 in. (33 cm)  |
|                          | Cargo Box<br>Dimensions      | 38 x 54.5 x 12 in. (96.5 x 138.4 x 30.5 cm)   |   |   |
|                          | Cargo Box Capacity           | 1,000 lb (454 kg) / Call home only: 600 lb (272.2 kg)   |   |   |
|                          | Power Tilt Bed               | N/A   |   |   |
|                          | Tailgate Load Capacity       | 250 lb (113.4 kg)   |   |   |
|                          | Storage Capacity             | Total: 10.4 gal (39.5 L)  |   |   |
|                          | Towing Capacity              | 2,500 lb (1,134 kg)   |   |   |
|                          | Payload Capacity             | 1,500 lb (680 kg)   |   |   |
|                          | Fuel Capacity                | 10.6 gal (40 L)   |   |   |
| Person Capacity          | 3                            |   |   |   |
| FEATURES                 | Gauge                        | 4.5 in. wide digital display  |   |   |
|                          | Battery                      | 12 V (8 amp/h)  |   |   |
|                          | Magneto                      | 650 W   |   |   |
|                          | Instrumentation              | DC outlet (10 A)  |   |   |
|                          | Lighting                     | Front lighting output 140 W<br>LED taillights   |   |   |
|                          | Winch                        | N/A   |   |   |
|                          | Seat                         | VERSA-PRO bench seat with passenger seats flipping up<br>Underseat hooks                                    |   |   |
|                          | Steering Wheel               | Adjustable tilt steering  |   |   |
|                          | Protection                   | Integrated front steel bumper<br>HMWPE central skid plate   |   |   |
|                          | Hitch Type                   | 2 in. hitch receiver  |   |   |

Visco-Lok is a trademark of GKN Visco-Lok GmbH.

\*\*\*1-year BRP limited warranty. BEST term available up to 30 months.



| DEFENDER***             |                        | XT***   |   |   |
|-------------------------|------------------------|---|---|---|
|                         |                        |    |  |  |
| COLOR OPTIONS           |                        | Stone Gray<br>W Highland Camo   | Fiery Red<br>Stone Gray<br>Timless Black<br>W Highland Camo                       | Fiery Red<br>Stone Gray<br>Timless Black<br>W Highland Camo                         |
| ENGINES                 | Type                   | HD 7  | HD 9  | HD 10   |
|                         | Fuel Delivery System   | 52 hp / 42 b-ft, Rotax® ACE (Advanced Combustion Efficiency) 650 cc single cylinder, liquid-cooled                                  |   |   |
|                         | Transmission           | 65 hp / 59 b-ft, Rotax® 976 cc, V-twin, liquid-cooled   |   |   |
|                         | Drive Train            | 82 hp / 69 b-ft, Rotax® 976 cc, V-twin, liquid-cooled   |   |   |
|                         | Driving Assistance     | Intelligent Throttle Control (ITC™) w/ Electronic Fuel Injection (EFI)  |   |   |
|                         | Power Steering         | PRO-TORQ CVT w/ Quick Response System (QRS), high airflow ventilation and Electronic Drive Belt Protection, Extra-L / H / N / R / P |   |   |
|                         | Drive Train            | Selectable Turf Mode / 2W D / 4W D w/ Visco-Lok® QE auto-locking front differential   | Selectable Turf Mode / 2W D / 4W D w/ Visco-Lok® auto-locking front differential  |   |
| SUSPENSIONS             | Front Suspension       | Double A-arm / 10 in. (25.4 cm) suspension travel   |   | Arched double A-arm / 11 in. (27.9 cm) suspension travel                            |
|                         | Front Shocks           | Tw in tube gas-charged shocks   |   |   |
|                         | Rear Suspension        | TTA w/ external sway bar / 10 in. (25.4 cm) suspension travel   |   | Arched TTA w/ external sway bar / 11 in. (27.9 cm) suspension travel                |
|                         | Rear Shocks            | Tw in tube gas-charged shocks   |   |   |
| TIRES & WHEELS          | Front / Rear Tires     | XPS TrailForce 27 x 9 / 11 x 14 in. 14 in. cast-alum rim  |   | XPS TrailKing 27 x 9 / 11 x 14 in. 14 in. cast-alum rim                             |
|                         | Wheels                 |   |   |   |
| BRAKES                  | Front                  | Dual 220 mm disc brakes w/ hydraulic twin-piston calipers   |   |   |
|                         | Rear                   | Dual 220 mm disc brakes w/ hydraulic single-piston calipers   |   |   |
|                         |                        | Brake holding mechanism   |   |   |
| DIMENSIONS & CAPACITIES | Cage                   | Profiled cage, ROPS approved  |   |   |
|                         | Estimated Dry Weight   | 1,577 lb (717 kg)   | 1,606 lb (728.5 kg)   | 1,623 lb (736 kg)   |
|                         | L x W x H              | 125.7 x 62 x 78 in. (319.4 x 157.5 x 198.1 cm)  |   | 125.7 x 64 x 80 in. (319.4 x 162.5 x 203.2 cm)                                      |
|                         | Wheelbase              | 83 in. (211.5 cm)   |   |   |
|                         | Ground Clearance       | 11 in. (28 cm)  |   | 13 in. (33 cm)  |
|                         | Cargo Box Dimensions   | 38 x 54.5 x 12 in. (96.5 x 138.4 x 30.5 cm)   |   |   |
|                         | Cargo Box Capacity     | 1,000 lb (454 kg) / California only: 600 lb (272.2 kg)  |   |   |
|                         | Power Tilt Bed         | N/A   |   |   |
|                         | Tailgate Load Capacity | 250 lb (113.4 kg)   |   |   |
|                         | Storage Capacity       | Total: 16.2 gal (61.3 L)  |   |   |
|                         | Towing Capacity        | 2,500 lb (1,134 kg)   |   |   |
|                         | Payload Capacity       | 1,500 lb (680 kg)   |   |   |
|                         | Fuel Capacity          | 10.6 gal (40 L)   |   |   |
| Person Capacity         | 3                      |   |   |   |
| FEATURES                | Gauge                  | 4.5 in. wide digital display  |   |   |
|                         | Battery                | 12 V (60 amp/h)   |   |   |
|                         | Magneto                | 650 W   |   |   |
|                         | Instrumentation        | DC outlet (10 A)<br>USB port (10 A) x 2   |   |   |
|                         | Lighting               | Front lighting output 140 W<br>LED tail lights  |   |   |
|                         | Winch                  | 4,500 lb (2,041 kg) w/ inch w/ roller fairlead  |   |   |
|                         | Seat                   | VERSA-PRO bolster bench seats w/ passenger seats flipping up, adjustable driver's seat, underseat hooks, mesh XT seat skin          |   |   |
|                         | Steering Wheel         | Adjustable tilt steering  |   |   |
|                         | Protection             | XT frontbumper<br>HMW PE fender skirt plate<br>Full hard roof   |   |   |
|                         | Hitch Type             | 2 in. hitch receiver  |   |   |

\*Visco-Lok is a trademark of GKN Viscotrade GmbH.



\*\*\*1-year BRP limited warranty. B.E.S.T. term available up to 30 months.



| DEFENDER                |                        | DPS CAB***  | X mr***   | X mr with half doors***   |
|-------------------------|------------------------|---|---|---|
|                         |                        |    |   |                                      |
| COLOR OPTIONS           |                        | Tundra Green  | HyperSilver & Legion Red<br>Whisper Camo  | HyperSilver & Legion Red  |
| ENGINES                 | Type                   | HD9<br>65 hp / 59 b-ft, Rotax® 976 cc, V-twin, liquid-cooled  | HD10<br>82 hp / 69 b-ft, Rotax® 976 cc, V-twin, liquid-cooled with strategically positioned engine air intake   | HD10  |
|                         | Fuel Delivery System   | Intelligent Throttle Control (ITC™)<br>with Electronic Fuel Injection (EFI)   | Intelligent Throttle Control (ITC™)<br>with Electronic Fuel Injection (EFI)   |   |
|                         | Transmission           | PRO-TORQ CVT with Quick Response System (QRS), high airflow ventilation and Electronic Drive Belt Protection, Extra-L / H / N / R / P   | PRO-TORQ CVT with Quick Response System (QRS), Electronic Drive Belt Protection, low gearing ratio and high airflow ventilation with strategically positioned CVT air intake and exhaust, Extra-L / H / N / R / P |   |
|                         | Drive Train            | Selectable Turf Mode / 2WD / 4WD<br>with Visco-Lok® auto-locking front differential   | Selectable Turf Mode / 2WD / 4WD TRAIL / 4WD MUD<br>with exclusive Sm art-Lok®  |   |
|                         | Driving Assistance     | Electronic Hill Descent Control,<br>ECO™ / ECO™ OFF / Work modes  | Electronic Hill Descent Control,<br>ECO™ / ECO™ OFF / Work modes  |   |
|                         | Power Steering         | Dynamic Power Steering (DPS™)   | Dynamic Power Steering (DPS™)   |   |
|                         | SUSPENSIONS            | Front Suspension  | Arched double A-arm with sway bar/<br>12 in. (30.5 cm) suspension travel  | Arched double A-arm with sway bar/<br>12 in. (30.5 cm) suspension travel  |
| Front Shocks            |                        | Twin tube gas-charged shocks  | Twin tube gas-charged shocks  |   |
| Rear Suspension         |                        | Arched TTA with external sway bar/<br>12 in. (30.5 cm) suspension travel  | Arched TTA with external sway bar/<br>12 in. (30.5 cm) suspension travel  |   |
| Rear Shocks             |                        | Twin tube gas-charged shocks  | Twin tube gas-charged shocks  |   |
| TIRES & WHEELS          | Front / Rear Tires     | XPS TrailForce 27 x 9 / 11 x 14 in.<br>14 in. cast-aluminum   | XPS Swamp Force 30 x 9 / 11 x 14 in.<br>14 in. cast-aluminum  |   |
|                         | Wheels                 |   |   |   |
| BRAKES                  | Front                  | Dual 220 mm disc brakes with hydraulic twin-piston calipers   | Dual 220 mm disc brakes with hydraulic twin-piston calipers   |   |
|                         | Rear                   | Dual 220 mm disc brakes with hydraulic single-piston calipers   | Dual 220 mm disc brakes with hydraulic single-piston calipers   |   |
|                         |                        | N/A   | Brake holding mechanism   |   |
| DIMENSIONS & CAPACITIES | Cage                   | Perforated cage, ROPS approved  | Perforated cage, ROPS approved  |   |
|                         | Estimated Dry Weight   | 1,830 lb (830 kg)   | 1,746 lb (792 kg)   | 1,811 lb (821 kg)   |
|                         | L x W x H              | 121 x 65 x 80 in. (307.1 x 165.1 x 226 cm)  | 129.4 x 64 x 82 in. (328.6 x 162.6 x 208.3 cm)  |   |
|                         | Wheelbase              | 83 in. (211.5 cm)   | 83 in. (211.5 cm)   |   |
|                         | Ground Clearance       | 13 in. (33.0 cm)  | 15 in. (38.1 cm)  |   |
|                         | Cargo Box Dimensions   | 38 x 54.5 x 12 in. (96.5 x 138.4 x 30.5 cm)   | 38 x 54.5 x 12 in. (96.5 x 138.4 x 30.5 cm)   |   |
|                         | Cargo Box Capacity     | 1,000 lb (454 kg) / Callibrations only: 600 lb (272.2 kg)   | 1,000 lb (454 kg) / Callibrations only: 600 lb (272.2 kg)   |   |
|                         | Power Tilt Bed         | N/A   | N/A   |   |
|                         | Tailgate Load Capacity | 250 lb (113.4 kg)   | 250 lb (113.4 kg)   |   |
|                         | Storage Capacity       | Total: 10.4 gal (39.5 L)  | Total: 16.2 gal (61.3 L)  |   |
|                         | Towing Capacity        | 2,500 lb (1,134 kg)   | 2,500 lb (1,134 kg)   |   |
|                         | Payload Capacity       | 1,200 lb (544 kg)   | 1,500 lb (680 kg)   |   |
|                         | Fuel Capacity          | 10.6 gal (40 L)   | 10.6 gal (40 L)   |   |
|                         | Person Capacity        | 3   | 3   |   |
| FEATURES                | Gauge                  | 4.5 in. wide digital display  | 7.6 in. wide digital display with keypad  |   |
|                         | Battery                | 12 V (60 amp/h)   | 12 V (60 amp/h)   |   |
|                         | Magneto                | 650 W   | 650 W   |   |
|                         | Instrumentation        | DC outlet (10 A)  | DC outlet (10 A), USB port (10 A) x 2   |   |
|                         | Lighting               | Front lighting output 140 W, LED taillights   | Front lighting output 140 W, LED signature, LED taillights  |   |
|                         | Winch                  | N/A   | Relocated 4,500 lb (2,041 kg) winch with synthetic rope and roller fairlead   |   |
|                         | Seat                   | VERSA-PRO bench seat with passenger seats flipping up, underseat hooks  | VERSA-PRO booster bench seats with passenger seats flipping up, adjustable driver's seat, underseat hooks, reinforced seats skin featuring X package trim   |   |
|                         | Steering Wheel         | Adjustable tilt steering  | Adjustable tilt steering  |   |
|                         | Protection             | Integrated front steel bumper per<br>HMW PE central skid plate<br>Full body front and rear interior dome light<br>Full body front door with electric opening windows<br>3-position fill light tilt-up windshield wiper/washer kit<br>Rear glass window<br>Heating and ventilation | Heavy-duty front steel bumper per<br>HMW PE full skid plate<br>Aluminum rock sliders<br>Mudguards   | Premium half doors<br>Heavy-duty front steel bumper per<br>HMW PE full skid plate<br>Aluminum rock sliders<br>Mudguards |
|                         | Hitch Type             | 2 in. hitch receiver  | 2 in. hitch receiver  |   |

Visco-Lok is a trademark of GKN Viscotek GmBH.

\*\*\*1-year BRP limited warranty. B.E.S.T. term available up to 30 months.



| DEFENDER              |  | Limited***  | MAX***   |   |
|-----------------------|--|---|--|---|
|                       |  |    |                   |    |
| COLOR OPTIONS         |  | Flint Red<br>Stone Gray<br>Desert Tan 4 Trimless Black<br>Wildland Camo   | Tundra Green   | Tundra Green  |
| ENGINES               | Type   | HD10  | HD7  | HD9   |
|                       | Fuel Delivery System   | 82 hp / 69 b-ft, Rotax® 976 cc, V-twin, liquid-cooled   | 52 hp / 42 b-ft, Rotax® ACE (Advanced Combustion Efficiency) 650 cc single cylinder, liquid-cooled | 65 hp / 59 b-ft, Rotax® 976 cc, V-twin, liquid-cooled   |
|                       | Transmission   | Intelligent Throttle Control (ITC™) with Electronic Fuel Injection (EFI)  | Intelligent Throttle Control (ITC™) with Electronic Fuel Injection (EFI)                           | Intelligent Throttle Control (ITC™) with Electronic Fuel Injection (EFI)  |
|                       | Drive Train  | PRO-TORQ CVT with Quick Response System (QRS), high airflow ventilation and Electronic Drive Belt Protection, Extra-L / H / N / R / P   | PRO-TORQ CVT with engine braking and Electronic Drive Belt Protection, L / H / N / R / P           | PRO-TORQ CVT with Quick Response System (QRS), high airflow ventilation and Electronic Drive Belt Protection, Extra-L / H / N / R / P |
|                       | Driving Assistance   | Selectable Turf Mode / 2W D / 4W D with exclusive Smart-Lok*  | Selectable Turf Mode / 2W D / 4W D with Visco-Lok® auto-locking front differential                 | Selectable Turf Mode / 2W D / 4W D with Visco-Lok® auto-locking front differential  |
|                       | Power Steering   | Electronic Hill Descent Control, ECO™ / ECO™ OFF / W ork modes  | Electronic Hill Descent Control, ECO™ / ECO™ OFF / W ork modes                                     | Electronic Hill Descent Control, ECO™ / ECO™ OFF / W ork modes  |
|                       | Power Steering   | Dynamik Power Steering (DPS™)   | N/A  | N/A   |
| SUSPENSIONS           | Front Suspension   | Arched double A-arm with sway bar / 12 in. (60.5 cm) suspension travel  | Double A-arm / 10 in. (25.4 cm) suspension travel  | Double A-arm / 10 in. (25.4 cm) suspension travel   |
|                       | Front Shocks   | Twin tube gas-charged shocks  | Twin tube gas-charged shocks   | Twin tube gas-charged shocks  |
|                       | Rear Suspension  | Arched TTA with external sway bar / 12 in. (60.5 cm) suspension travel  | TTA with external sway bar / 10 in. (25.4 cm) suspension travel                                    | TTA with external sway bar / 10 in. (25.4 cm) suspension travel   |
|                       | Rear Shocks  | Twin tube gas-charged shocks  | Twin tube gas-charged shocks   | Twin tube gas-charged shocks  |
| TIRES WHEELS          | Front / Rear Tires<br>XPS TrailForce 30 x 9 / 10 x 14 in. 14 in. cast aluminum | XPS TrailForce 27 x 9 / 11 x 14 in. 14 in. steel  | XPS TrailForce 27 x 9 / 11 x 14 in. 14 in. steel   |   |
| BRAKES                | Front  | Dual 220 mm disc brakes with hydraulic twin-piston calipers   | Dual 220 mm disc brakes with hydraulic twin-piston calipers  | Dual 220 mm disc brakes with hydraulic twin-piston calipers   |
|                       | Rear   | Dual 220 mm disc brakes with hydraulic single-piston calipers   | Dual 220 mm disc brakes with hydraulic twin-piston calipers  | Dual 220 mm disc brakes with hydraulic twin-piston calipers   |
|                       | Brake Holding Mechanism  | Brake holding mechanism   | N/A  | N/A   |
| DIMENSIONS CAPACITIES | Cage   | Profiled cage, ROPS approved  | Profiled cage, ROPS approved   | Profiled cage, ROPS approved  |
|                       | Estimated Dry Weight   | 1,976 lb (896 kg)   | 1,721 lb (781 kg)  | 1,753 lb (795 kg)   |
|                       | L x W x H  | 126 x 65 x 81 in. (319 x 165.1 x 252 cm)  | 153.4 x 63.5 x 76 in. (389.6 x 161.2 x 193 cm)   | 153.4 x 63.5 x 76 in. (389.6 x 161.2 x 193 cm)  |
|                       | Wheelbase  | 83 in. (211.5 cm)   | 115.5 in. (294 cm)   | 115.5 in. (294 cm)  |
|                       | Ground Clearance   | 14 in. (65.6 cm)  | 11 in. (28 cm)   | 11 in. (28 cm)  |
|                       | Cargo Box Dimensions   | 38 x 54.5 x 12 in. (96.5 x 138.4 x 30.5 cm)   | 38 x 54.5 x 12 in. (96.5 x 138.4 x 30.5 cm)  | 38 x 54.5 x 12 in. (96.5 x 138.4 x 30.5 cm)   |
|                       | Cargo Box Capacity   | 1,000 lb (454 kg) / California only: 600 lb (272.2 kg)  | 1,000 lb (454 kg) / California only: 600 lb (272.2 kg)   | 1,000 lb (454 kg) / California only: 600 lb (272.2 kg)  |
|                       | Power Tilt Bed   | N/A   | N/A  | N/A   |
|                       | Tailgate Load Capacity   | 250 lb (113.4 kg)   | 250 lb (113.4 kg)  | 250 lb (113.4 kg)   |
|                       | Storage Capacity   | Total: 12.7 gal (48.1 L)  | Total: 3.1 gal (11.7 L)  | Total: 3.1 gal (11.7 L)   |
|                       | Towing Capacity  | 2,500 lb (1,134 kg)   | 2,500 lb (1,134 kg)  | 2,500 lb (1,134 kg)   |
|                       | Payload Capacity   | 1,200 lb (544 kg)   | 1,700 lb (771 kg)  | 1,700 lb (771 kg)   |
|                       | Fuel Capacity  | 10.6 gal (40 L)   | 10.6 gal (40 L)  | 10.6 gal (40 L)   |
| Person Capacity       | 3  | 6   | 6  |   |
| FEATURES              | Gauge  | 7.6 in. wide digital display with keypad  | 4.5 in. wide digital display   | 4.5 in. wide digital display  |
|                       | Battery  | 12 V (60 amp/h)   | 12 V (48 amp/h)  | 12 V (48 amp/h)   |
|                       | Magneto  | 850 W   | 650 W  | 650 W   |
|                       | Instrumentation  | DC outlet (10 A), USB port (1.0 A) x 2  | DC outlet (10 A)   | DC outlet (10 A)  |
|                       | Lighting   | Front lighting output 140 W, LED signature, LED taillights  | Front lighting output 140 W, LED taillights  | Front lighting output 140 W, LED taillights   |
|                       | Winch  | 4,500 lb (2,041 kg) winch with roller fairlead  | N/A  | N/A   |
|                       | Seat   | VERSA-PRO bolster bench seats with passenger seats flipping up, adjustable driver's seat, underside hooks, mesh faced seat skin featuring Lin'ed package trim s   | VERSA-PRO bench seat with passenger seats flipping up, underside hooks                             | VERSA-PRO bench seat with passenger seats flipping up, underside hooks  |
|                       | Steering Wheel   | Adjustable tilt steering  | Adjustable tilt steering   | Adjustable tilt steering  |
|                       | Protection   | Auto heating and air conditioning (HVAC) climate system<br>XT front bumper<br>HM WPE full ski plate<br>Full hard roof with interior and exterior dome light<br>Full cobra mesh doors with electric opening windows<br>3-position full glass tilt-up windshield with wiper/washer kit<br>Rear glass window | Integrated front steel bumper per HM WPE central ski plate   | Integrated front steel bumper per HM WPE central ski plate  |
|                       | Hitch Type   | 2 in. hitch receiver  | 2 in. hitch receiver   | 2 in. hitch receiver  |

\*Visco-Lok is a trademark of GKN Visco Drive GmbH.



\*\*Smart-Lok was developed in conjunction with the TEAM Industries, a market leader in the drive train industry.

\*\*\*1-year BRP limited warranty. B.E.S.T. term available up to 30 months.



| DEFENDER                 |                              | MAX DPS***  |   |   |
|--------------------------|------------------------------|---|---|---|
|                          |                              |                          |   |  |
| COLOR OPTIONS            |                              | Tundra Green<br>Tundra Camo   | Tundra Green<br>Tundra Camo   | Fairy Red<br>Tundra Camo  |
| ENGINES                  | Type                         | HD7<br>52 hp / 42 b-ft, Rotax® ACE (Advanced Combustion Efficiency) 650 cc single cylinder, liquid-cooled | HD9<br>65 hp / 59 b-ft, Rotax® 976 cc, V-twin, liquid-cooled  | HD10<br>82 hp / 69 b-ft, Rotax® 976 cc, V-twin, liquid-cooled                       |
|                          | Fuel Delivery System         | Intelligent Throttle Control (ITC™) with Electronic Fuel Injection (EFI)                                  |   |   |
|                          | Transmission                 | 5-speed primary CVT with engine braking and Electronic Drive Belt Protection, L/H/N/R/P                   | PRO-TORQ CVT with Quick Response System (QRS), high airflow ventilation and Electronic Drive Belt Protection, Extra-L/H/N/R/P |   |
|                          | Drive Train                  | Selectable Turf Mode / 2WD / 4WD with Visco-Lok® QE auto-locking front differential                       | Selectable Turf Mode / 2WD / 4WD with Visco-Lok® auto-locking front differential  |   |
|                          | Driving Assistance           | Electronic Hill Descent Control (ECO™) / ECO™ Off/Work modes  |   |   |
|                          | Power Steering               | Dynamic Power Steering (DPS™)   |   |   |
| SUSPENSIONS              | Front Suspension             | Double A-arm / 10 in. (25.4 cm) suspension travel   | Arched double A-arm / 11 in. (27.9 cm) suspension travel  |   |
|                          | Front Shocks                 | Twin tube gas-charged shocks  |   |   |
|                          | Rear Suspension              | TTA with external swaybar / 10 in. (25.4 cm) suspension travel  | Arched TTA with external swaybar / 11 in. (27.9 cm) suspension travel   |   |
|                          | Rear Shocks                  | Twin tube gas-charged shocks  |   |   |
| TIRES<br>WHEELS          | Front / Rear Tires<br>Wheels | XPS TrailForce 27 x 9 / 11 x 14 in.<br>14 in. cast-aluminum   |   | XPS TrailKing 27 x 9 / 11 x 14 in.<br>14 in. cast-aluminum                          |
|                          | BRAKES                       | Front   | Dual 220 mm disc brakes with hydraulic twin-piston calipers   |   |
| Rear                     |                              | Dual 220 mm disc brakes with hydraulic twin-piston calipers   |   |   |
| DIMENSIONS<br>CAPACITIES | Cage                         | Profiled cage, ROPS approved  |   |   |
|                          | Estimated Dry Weight         | 1,736 lb (787 kg)   | 1,771 lb (803 kg)   | 1,793 lb (813 kg)   |
|                          | L x W x H                    | 153.4 x 63.5 x 76 in. (389.6 x 161.2 x 193 cm)  |   | 153.4 x 64 x 77.5 in. (389.6 x 162.5 x 196.9 cm)                                    |
|                          | Wheelbase                    | 115.5 in. (294 cm)  |   |   |
|                          | Ground Clearance             | 11 in. (28 cm)  |   | 13 in. (33 cm)  |
|                          | Cargo Box Dimensions         | 38 x 54.5 x 12 in. (96.5 x 138.4 x 30.5 cm)   |   |   |
|                          | Cargo Box Capacity           | 1,000 lb (454 kg) / California only: 600 lb (272.2 kg)  |   |   |
|                          | Power Tilt Bed               | N/A   |   |   |
|                          | Tailgate Load Capacity       | 250 lb (113.4 kg)   |   |   |
|                          | Storage Capacity             | Total 111.1 gal (42.1 L)  |   |   |
|                          | Towing Capacity              | 2,500 lb (1,134 kg)   |   |   |
|                          | Payload Capacity             | 1,700 lb (771 kg)   |   |   |
|                          | Fuel Capacity                | 10.6 gal (40 L)   |   |   |
|                          | Person Capacity              | 6   |   |   |
| FEATURES                 | Gauge                        | 4.5 in. wide digital display  |   |   |
|                          | Battery                      | 12 V (18 amp/h)   |   |   |
|                          | Magneto                      | 650 W   |   |   |
|                          | Instrumentation              | DC outlet (10 A)  |   |   |
|                          | Lighting                     | Front lighting output 140 W, LED taillights   |   |   |
|                          | Winch                        | N/A   |   |   |
|                          | Seat                         | VERSA-PRO bench seat with passenger seats flipping up, underside hooks                                    |   |   |
|                          | Steering Wheel               | Adjustable tilt steering  |   |   |
|                          | Protection                   | Integrated front steel bumper<br>HMWPE central skid plate   |   |   |
|                          | Hitch Type                   | 2 in. hitch receiver  |   |   |

<sup>1</sup>Visco-Lok is a trademark of GKN Viscotek GmBH.  
<sup>2</sup>\*\*1-year BRP limited warranty. BEST term available up to 30 months.

| DEFENDER                |                        | MAX XT ***  |  | MAX Lone Star ***  |   | MAX Lone Star CAB ***                                    |  |  |
|-------------------------|------------------------|---|--|--|---|--|--|--|
|                         |                        |    |  |  |   |  |  |  |
| COLOR OPTIONS           |                        | Foxy Red<br>Stone Gray<br>Wildland Camo   |  | Night Black  |   | Night Black  |  |  |
| ENGINES                 | Type                   | HD 9<br>65 hp / 59 b-ft, Rotax® 976 cc, V-twin, liquid-cooled   | HD 10<br>82 hp / 69 b-ft, Rotax® 976 cc, V-twin, liquid-cooled         | HD 10<br>82 hp / 69 b-ft, Rotax® 976 cc, V-twin, liquid-cooled                     |   | HD 10  |  |  |
|                         | Fuel Delivery System   | Intelligent Throttle Control (ITC™) with Electronic Fuel Injection (EFI)  |  |  |   |  |  |  |
|                         | Transmission           | PRO-TORQ CVT with Quick Response System (QRS), high airflow ventilation and Electronic Drive Belt Protection, Extra-L / H / N / R / P |  |  |   |  |  |  |
|                         | Drive Train            | Selectable Turf Mode / 2WD / 4WD with Visco-Lok® auto-locking front differential  |  |  |   |  |  |  |
|                         | Driving Assistance     | Electronic Hill Descent Control, ECO™ / ECO™ OFF / Work modes   |  |  |   |  |  |  |
|                         | Power Steering         | Dynamic Power Steering (DPS™)   |  |  |   |  |  |  |
|                         | SUSPENSIONS            | Front Suspension  | Double A-arm / 10 in. (25.4 cm) suspension travel                      | Arched double A-arm / 11 in. (27.9 cm) suspension travel                           | Arched double A-arm with sway bar / 12 in. (30.5 cm) suspension travel  |  |  |  |
| Front Shocks            |                        | Twin tube gas-charged shocks  |  |  |   |  |  |  |
| Rear Suspension         |                        | TTA with external sway bar / 10 in. (25.4 cm) suspension travel   | Arched TTA with external sway bar / 11 in. (27.9 cm) suspension travel | Arched TTA with external sway bar / 12 in. (30.5 cm) suspension travel             |   |  |  |  |
| Rear Shocks             |                        | Twin tube gas-charged shocks  |  |  |   |  |  |  |
| TIRES & WHEELS          | Front / Rear Tires     | XPS TrailForce 27 x 9 / 11 x 14 in. 14 in. cast-aluminum  |  | XPS TrailKing 27 x 9 / 11 x 14 in. 14 in. cast-aluminum                            |   | XPS TrailForce 30 x 9 / 10 x 14 in. 14 in. cast-aluminum |  |  |
|                         | Wheels                 |   |  |  |   |  |  |  |
| BRAKES                  | Front                  | Dual 220 mm disc brakes with hydraulic twin-piston calipers   |  |  |   |  |  |  |
|                         | Rear                   | Dual 220 mm disc brakes with hydraulic twin-piston calipers   |  |  |   |  |  |  |
|                         |                        | Brake holding mechanism   |  |  |   |  |  |  |
| DIMENSIONS & CAPACITIES | Cage                   | Profiled cage, ROPS approved  |  |  |   |  |  |  |
|                         | Estimated Dry Weight   | 1,902 lb (863 kg)   | 1,928 lb (875 kg)  | 1,977 lb (897 kg)  | 2,538 lb (1,151 kg)   |  |  |  |
|                         | L x W x H              | 158.3 x 63.5 x 76 in. (402 x 161.2 x 193 cm)  |  | 158.3 x 64 x 79.5 in. (402 x 162.5 x 202 cm)                                       |   | 158.9 x 65 x 80.9 in. (403.6 x 165.1 x 228.5 cm)         |  |  |
|                         | Wheelbase              | 115.5 in. (294 cm)  |  |  |   |  |  |  |
|                         | Ground Clearance       | 11 in. (28 cm)  | 13 in. (33 cm)   |  | 14 in. (35.6 cm)  |  |  |  |
|                         | Cargo Box Dimensions   | 38 x 54.5 x 12 in. (96.5 x 138.4 x 30.5 cm)   |  |  |   |  |  |  |
|                         | Cargo Box Capacity     | 1,000 lb (454 kg) / Callibration only: 600 lb (272.2 kg)  |  |  |   |  |  |  |
|                         | Power Tilt Bed         | N/A   |  |  |   |  |  |  |
|                         | Tailgate Load Capacity | 250 lb (113.4 kg)   |  |  |   |  |  |  |
|                         | Storage Capacity       | Total: 16.9 gal (63.9 L)  |  | Total: 16.9 gal (63.9 L)   |   | Total: 12.7 gal (48.1 L)                                 |  |  |
|                         | Towing Capacity        | 2,500 lb (1,134 kg)   |  |  |   |  |  |  |
|                         | Payload Capacity       | 1,700 lb (771 kg)   |  | 1,700 lb (771 kg)  |   | 1,180 lb (535 kg)  |  |  |
|                         | Fuel Capacity          | 10.6 gal (40 L)   |  |  |   |  |  |  |
| Person Capacity         | 6                      |   |  |  |   |  |  |  |
| FEATURES                | Gauge                  | 4.5 in. wide digital display  |  | 7.6 in. wide digital display with keypad   |   |  |  |  |
|                         | Battery                | 12 V (80 amp/h)   |  |  |   |  |  |  |
|                         | Magneto                | 650 W   |  | 650 W  |   | 850 W  |  |  |
|                         | Instrumentation        | DC outlet (10 A), USB port (10 A) x 2   |  |  |   |  |  |  |
|                         | Lighting               | Front lighting output 140 W, LED taillights   |  |  |   |  |  |  |
|                         | Winch                  | 4,500 lb (2,041 kg) winch with roller fairlead  |  |  |   |  |  |  |
|                         | Seat                   | VERSA-PRO bolster bench seats with passenger seats flipping up, adjustable driver's seat, underside hooks, reinforced XT seat skin    |  |  | Dual VERSA-PRO bolster bench seats with passenger seats flipping up, adjustable driver's seat, underside hooks, reinforced seat skin featuring Lone Star package trim |  |  |  |
|                         | Steering Wheel         | Adjustable tilt steering  |  |  |   |  |  |  |
|                         | Protection             | XT front bumper per HMWPE fullskid plate<br>2-piece fullhard roof   |  |  | Heavy-duty front steel bumper per Alum num rock sliders<br>HMWPE fullskid plate<br>2-piece fullhard roof<br>Alum num rock sliders                                     |  | Heavy-duty front steel bumper per Alum num rock sliders<br>HMWPE fullskid plate<br>2-piece fullhard roof<br>Full cab with electric opening windows in front, 3-position full glass tilt-up windshield with wiper/washer kit<br>Rear glass window |  |
|                         | Hitch Type             | 2 in. hitch receiver  |  |  |   |  |  |  |

Visco-Lok is a trademark of GKN Visco Drive GmbH.

\*Smar-Lok was developed in conjunction with the TEAM Industries, a market leader in the drive train industry.

\*\*\*1-year BRP limited warranty. B.E.S.T. term available up to 30 months.





| DEFENDER                |                             | MAX Limited***  | MAX X mr***   | MAX X mr with half doors***  |
|-------------------------|-----------------------------|---|---|--|
|                         |                             |    |   |   |
| COLOR OPTIONS           |                             | Fiery Red<br>Stone Gray<br>Desert Tan & Tireless Black<br>Wildland Camo   | Wildland Camo   | HyperSilver & Legion Red   |
| ENGINES                 | Type                        | HD10  | HD10  | HD10   |
|                         | Fuel Delivery System        | 82 hp / 69 b-ft, Rotax® 976 cc, V-twin, liquid-cooled   | 82 hp / 69 b-ft, Rotax® 976 cc, V-twin, liquid-cooled with strategically positioned engine air intake   |  |
|                         | Transmission                | Intelligent Throttle Control (ITC™) with Electronic Fuel Injection (EFI)  | Intelligent Throttle Control (ITC™) with Electronic Fuel Injection (EFI)  |  |
|                         | Transmission                | PRO-TOUR CVT with Quick Response System (QRS), high airflow ventilation and Electronic Drive Belt Protection, Extra-L / H / N / R / P   | PRO-TOUR CVT with Quick Response System (QRS), Electronic Drive Belt Protection, low gearing ratio and high airflow ventilation with strategically positioned CVT air intake and exhaust, Extra-L / H / N / R / P | PRO-TOUR Transmission with Quick Response System (QRS), Electronic Drive Belt Protection, low gearing ratio and high airflow ventilation with strategically positioned CVT air intake and exhaust, Extra-L / H / N / R / P |
|                         | Drive Train                 | Selectable Turf Mode / 2WD / 4WD with exclusive Sm art-Lok*   | Selectable Turf Mode / 2WD / 4WD TRAIL / 4WD MUD with exclusive Sm art-Lok*   |  |
|                         | Driving Assistance          | Electronic Hill Descent Control, ECO™ / ECO™ OFF / Work modes   | Electronic Hill Descent Control, ECO™ / ECO™ OFF / Work modes   |  |
|                         | Power Steering              | Dynamic Power Steering (DPS™)   | Dynamic Power Steering (DPS™)   |  |
| SUSPENSIONS             | Front Suspension            | Arched double A-arm with sway bar / 12 in. (30.5 cm) suspension travel  | Arched double A-arm with sway bar / 12 in. (30.5 cm) suspension travel  |  |
|                         | Front Shocks                | Twin tube gas-charged shocks  | Twin tube gas-charged shocks  |  |
|                         | Rear Suspension             | Arched TTA with external sway bar / 12 in. (30.5 cm) suspension travel  | Arched TTA with external sway bar / 12 in. (30.5 cm) suspension travel  |  |
|                         | Rear Shocks                 | Twin tube gas-charged shocks  | Twin tube gas-charged shocks  |  |
| TIRES / WHEELS          | Front / Rear Tires / Wheels | XPS Trac Force 30 x 9 / 10 x 14 in. 14 in. cast-aluminum  | XPS Swamp Force 30 x 9 / 11 x 14 in. 14 in. cast-aluminum   |  |
|                         | BRAKES                      | Front   | Dual 220 mm disc brakes with hydraulic twin-piston calipers   |  |
| Rear                    |                             | Dual 220 mm disc brakes with hydraulic twin-piston calipers   |   |  |
| DIMENSIONS / CAPACITIES |                             | Brake holding mechanism   |   | Brake holding mechanism  |
|                         | Cage                        | Profiled cage, ROPS approved  |   |  |
|                         | Estimated Dry Weight        | 2,466 lb (1,119 kg)   | 2,060 lb (934 kg)   | 2,174 lb (986 kg)  |
|                         | L x W x H                   | 158 x 65 x 81 in. (#02 x 165.1 x 226 cm)  |   |  |
|                         | Wheelbase                   | 115.5 in. (294 cm)  |   |  |
|                         | Ground Clearance            | 14 in. (35.6 cm)  |   |  |
|                         | Cargo Box Dimensions        | 38 x 54.5 x 12 in. (96.5 x 138.4 x 30.5 cm)   |   |  |
|                         | Cargo Box Capacity          | 1,000 lb (454 kg) / California only: 600 lb (272.2 kg)  |   |  |
|                         | Power Tilt Bed              | N/A   |   |  |
|                         | Tailgate Load Capacity      | 250 lb (113.4 kg)   |   |  |
|                         | Storage Capacity            | Total: 12.7 gal (#8.1 L)  |   |  |
|                         | Towing Capacity             | 2,500 lb (1,134 kg)   |   |  |
|                         | Payload Capacity            | 1,225 lb (555 kg)   | 1,550 lb (703 kg)   | 1,425 lb (646 kg)  |
|                         | Fuel Capacity               | 10.6 gal (#0 L)   |   |  |
| Person Capacity         | 6                           |   |   |  |
| FEATURES                | Gauge                       | 7.6 in. wide digital display with keypad  |   |  |
|                         | Battery                     | 12 V (60 amp/h)   |   |  |
|                         | Magneto                     | 850 W   |   |  |
|                         | Instrumentation             | DC outlet (10 A), USB port (10 A) x 2   |   |  |
|                         | Lighting                    | Front lighting output 140 W, LED signature, LED taillights  |   |  |
|                         | Winch                       | 4,500 lb (2,041 kg) winch with roller fairlead  |   |  |
|                         | Seat                        | Relocated 4,500 lb (2,041 kg) winch with synthetic rope and roller fairlead   |   |  |
|                         | Seat                        | VERSA-PRO bolster/bench seats with passenger seats flipping up, adjustable driver's seat, underside hooks, reinforced seatskin featuring Lin Bed package trim s   |   |  |
|                         | Steering Wheel              | Adjustable tilt steering  |   |  |
|                         | Protection                  | XT front bumper<br>HMWPE full-ski plate<br>Full hard roof with liner and interior dome light<br>Full color mesh doors with electric opening windows in front<br>3-position fuel gas tilt-up windshield with wiper/washer kit<br>Rear glass window | Heavy-duty front steel bumper<br>HMWPE full-ski plate<br>Aluminum rock sliders<br>Mudguards   | Premium half doors<br>Heavy-duty front steel bumper<br>HMWPE full-ski plate<br>Aluminum rock sliders<br>Mudguards  |
| Hitch Type              | 2 in. hitch receiver        |   |   |  |

\*V-Scan-Lok is a trademark of GKN Viscodrive GmbH.

\*Sm art-Lok was developed in conjunction with TEAM Industries, a market leader in the drive train industry.

\*\*\*1-year BRP limited warranty. B.E.S.T. term available up to 30 months.



| DEFENDER                |                              | PRO DPS***  | PRO XT***   | PRO Limited***  |
|-------------------------|------------------------------|---|---|---|
|                         |                              |    |    |    |
| COLOR OPTIONS           |                              | Tundra Green<br>Yellow  | Timex Black   | Stone Gray  |
| ENGINES                 | Type                         | HD10  | HD10  | HD10  |
|                         |                              | 82 hp / 69 b-ft, Rotax® 976 cc, V-twin, liquid-cooled   | 82 hp / 69 b-ft, Rotax® 976 cc, V-twin, liquid-cooled   | 82 hp / 69 b-ft, Rotax® 976 cc, V-twin, liquid-cooled   |
|                         | Fuel Delivery System         | Intelligent Throttle Control (ITC™) with Electronic Fuel Injection (EFI)  | Intelligent Throttle Control (ITC™) with Electronic Fuel Injection (EFI)  | Intelligent Throttle Control (ITC™) with Electronic Fuel Injection (EFI)  |
|                         | Transmission                 | PRO-TORQ CVT with Quick Response System (QRS), high airflow ventilation and Electronic Drive Belt Protection, Extra-L / H / N / R / P | PRO-TORQ CVT with Quick Response System (QRS), high airflow ventilation and Electronic Drive Belt Protection, Extra-L / H / N / R / P | PRO-TORQ CVT with Quick Response System (QRS), high airflow ventilation and Electronic Drive Belt Protection, Extra-L / H / N / R / P   |
|                         | Drive Train                  | Selectable Turf mode / 2W D / 4W D with Visco-Lok® auto-locking front differential  | Selectable Turf mode / 2W D / 4W D with Visco-Lok® auto-locking front differential  | Selectable Turf mode / 2W D / 4W D with exclusive Smart-Lok*  |
|                         | Driving Assistance           | Electronic Hill Descent Control, ECO™ / ECO™ OFF / Work modes   | Electronic Hill Descent Control, ECO™ / ECO™ OFF / Work modes   | Electronic Hill Descent Control, ECO™ / ECO™ OFF / Work modes   |
|                         | Power Steering               | Dynamic Power Steering (DPS™)   | Dynamic Power Steering (DPS™)   | Dynamic Power Steering (DPS™)   |
| SUSPENSIONS             | Front Suspension             | Arched double A-arm / 11 in. (27.9 cm) suspension travel  | Arched double A-arm / 11 in. (27.9 cm) suspension travel  | Arched double A-arm with sway bar / 12 in. (30.5 cm) suspension travel  |
|                         | Front Shocks                 | Twin tube gas-charged shocks  | Twin tube gas-charged shocks  | Twin tube gas-charged shocks  |
|                         | Rear Suspension              | Arched TTA with external sway bar / 11 in. (27.9 cm) suspension travel  | Arched TTA with external sway bar / 11 in. (27.9 cm) suspension travel  | Arched TTA with external sway bar / 12 in. (30.5 cm) suspension travel  |
|                         | Rear Shocks                  | Twin tube gas-charged shocks  | Twin tube gas-charged shocks  | Twin tube gas-charged shocks  |
| TIRES & WHEELS          | Front / Rear Tires<br>Wheels | XPS TrailKing 27 x 9 / 11 x 14 in.<br>14 in. cast-alum rim  | XPS TrailKing 27 x 9 / 11 x 14 in.<br>14 in. cast-alum rim  | XPS Tac Force 30 x 9 / 10 x 14 in.<br>14 in. cast-alum rim  |
| BRAKES                  | Front                        | Dual 220 mm disc brakes with hydraulic twin-piston calipers   | Dual 220 mm disc brakes with hydraulic twin-piston calipers   | Dual 220 mm disc brakes with hydraulic twin-piston calipers   |
|                         | Rear                         | Dual 220 mm disc brakes with hydraulic twin-piston calipers   | Dual 220 mm disc brakes with hydraulic twin-piston calipers   | Dual 220 mm disc brakes with hydraulic twin-piston calipers   |
| DIMENSIONS & CAPACITIES |                              | N/A   | Brake holding mechanism   | Brake holding mechanism   |
|                         | Cage                         | Profiled cage, ROPS approved  | Profiled cage, ROPS approved  | Profiled cage, ROPS approved  |
|                         | Estimated Dry Weight         | 1,815 lb (823 kg)   | 1,942 lb (881 kg)   | 2,309 lb (1,047 kg)   |
|                         | L x W x H                    | 154.1 x 64 x 78 in. (391.5 x 162.5 x 198.1 cm)  | 159.7 x 64 x 80 in. (405.7 x 162.5 x 203.3 cm)  | 159.7 x 65 x 81 in. (405.7 x 165.1 x 228.7 cm)  |
|                         | Wheelbase                    | 115.5 in. (294 cm)  | 115.5 in. (294 cm)  | 115.5 in. (294 cm)  |
|                         | Ground Clearance             | 13 in. (33 cm)  | 13 in. (33 cm)  | 14 in. (35.6 cm)  |
|                         | Cargo Box Dimensions         | 72 x 54.5 x 10 in. (183 x 138.4 x 25.4 cm)  | 72 x 54.5 x 10 in. (183 x 138.4 x 25.4 cm)  | 72 x 54.5 x 10 in. (183 x 138.4 x 25.4 cm)  |
|                         | Cargo Box Capacity           | 1,000 lb (454 kg) / California only: 600 lb (272.2 kg)  | 1,000 lb (454 kg) / California only: 600 lb (272.2 kg)  | 1,000 lb (454 kg) / California only: 600 lb (272.2 kg)  |
|                         | Power Tilt Bed               | N/A   | Hydraulic power tilt bed  | Hydraulic power tilt bed  |
|                         | Tailgate Load Capacity       | 250 lb (113.4 kg)   | 250 lb (113.4 kg)   | 250 lb (113.4 kg)   |
|                         | Storage Capacity             | Total: 94 gal (356 L)   | Total: 100.5 gal (380.4 L)  | Total: 100.5 gal (380.4 L)  |
|                         | Towing Capacity              | 2,500 lb (1,134 kg)   | 2,500 lb (1,134 kg)   | 2,500 lb (1,134 kg)   |
|                         | Payload Capacity             | 1,570 lb (712 kg)   | 1,570 lb (712 kg)   | 1,320 lb (598 kg)   |
|                         | Fuel Capacity                | 10.6 gal (40 L)   | 10.6 gal (40 L)   | 10.6 gal (40 L)   |
| Person Capacity         | 3                            | 3   | 3   |   |
| FEATURES                | Gauge                        | 4.5 in. wide digital display  | 4.5 in. wide digital display  | 7.6 in. wide digital display with keypad  |
|                         | Battery                      | 12 V (8 am p/h)   | 12 V (8 am p/h)   | 12 V (8 am p/h)   |
|                         | Magneto                      | 650 W   | 650 W   | 850 W   |
|                         | Instrumentation              | DC outlet (10 A)  | DC outlet (10 A), USB port (10 A) x 2   | DC outlet (10 A), USB port (10 A) x 2   |
|                         | Lighting                     | Front lighting output 140 W, LED taillights   | Front lighting output 140 W, LED taillights   | Front lighting output 140 W, LED signature, LED taillights  |
|                         | Winch                        | N/A   | 4,500 lb (2,041 kg) winch with roller fairlead  | 4,500 lb (2,041 kg) winch with roller fairlead  |
|                         | Seat                         | VERSA-PRO bench seat with passenger seats flipping up, underside hooks  | VERSA-PRO bolster bench seats with passenger seats flipping up, adjustable driver's seat, underside hooks, reinforced XT seatskin     | VERSA-PRO bolster bench seats with passenger seats flipping up, adjustable driver's seat, underside hooks, reinforced seatskin featuring Limited package trim s   |
|                         | Steering Wheel               | Adjustable tilt steering  | Adjustable tilt steering  | Adjustable tilt steering  |
|                         | Protection                   | Integrated front steel bumper per HMW PE central ski plate  | XT front bumper per HMW PE full ski plate<br>Full hard roof   | XT front bumper per HMW PE full ski plate<br>Full hard roof with therand interdoor e light<br>Full color match doors with electric opening windows, 3-position full glass tie-up windshield with wiper/washer kit<br>Rear glass window<br>Panorama mirror |
|                         | Hitch Type                   | 2 in. hitch receiver  | 2 in. hitch receiver  | 2 in. hitch receiver  |

\*Visco-Lok is a trademark of GKN Viscodrive GmbH.

\*\*Smart-Lok was developed in conjunction with TEAM Industries, a market leader in the drive train industry.

\*\*\*1-year BRP limited warranty. B.E.S.T. term available up to 30 months.



| DEFENDER                |                              | 6x6 DPS***  | 6x6 XT***  | 6x6 Limited***   |
|-------------------------|------------------------------|---|--|--|
|                         |                              |    |    |   |
| COLOR OPTIONS           |                              | Tundra Green  | Fenty Red  | Fenty Red  |
| ENGINES                 | Type                         | HD10  | HD10   | HD10   |
|                         |                              | 82 hp / 69 b-ft, Rotax® 976 cc, V-twin, liquid-cooled   | 82 hp / 69 b-ft, Rotax® 976 cc, V-twin, liquid-cooled  | 82 hp / 69 b-ft, Rotax® 976 cc, V-twin, liquid-cooled  |
|                         | Fuel Delivery System         | Intelligent Throttle Control (ITC™) with Electronic Fuel Injection (EFI)  | Intelligent Throttle Control (ITC™) with Electronic Fuel Injection (EFI)   | Intelligent Throttle Control (ITC™) with Electronic Fuel Injection (EFI)   |
|                         | Transmission                 | PRO-TORQ CVT with Quick Response System (QRS), high airflow ventilation and Electronic Drive Belt Protection, Extra-L/H/N/R/P | PRO-TORQ CVT with Quick Response System (QRS), high airflow ventilation and Electronic Drive Belt Protection, Extra-L/H/N/R/P      | PRO-TORQ CVT with Quick Response System (QRS), high airflow ventilation and Electronic Drive Belt Protection, Extra-L/H/N/R/P  |
|                         | Drive Train                  | Selectable 4WD / 6WD with Visco-Lok® auto-locking front differential  | Selectable 4WD / 6WD with Visco-Lok® auto-locking front differential   | Selectable 4WD / 6WD with exclusive Smart-Lok*   |
|                         | Driving Assistance           | Electronic Hill Descent Control, ECO™ / ECO™ OFF / Work modes   | Electronic Hill Descent Control, ECO™ / ECO™ OFF / Work modes  | Electronic Hill Descent Control, ECO™ / ECO™ OFF / Work modes  |
|                         | Power Steering               | Dynamic Power Steering (DPS™)   | Dynamic Power Steering (DPS™)  | Dynamic Power Steering (DPS™)  |
| SUSPENSIONS             | Front Suspension             | Arched double A-arm / 11 in. (27.9 cm) suspension travel  | Arched double A-arm / 11 in. (27.9 cm) suspension travel   | Arched double A-arm with sway bar / 12 in. (30.5 cm) suspension travel   |
|                         | Front Shocks                 | Twin tube gas-charged shocks  | Twin tube gas-charged shocks   | Twin tube gas-charged shocks   |
|                         | Rear Suspension              | Arched TTA with external sway bar / 11 in. (27.9 cm) suspension travel  | Arched TTA with external sway bar / 11 in. (27.9 cm) suspension travel   | Arched TTA with external sway bar / 12 in. (30.5 cm) suspension travel   |
|                         | Rear Shocks                  | Twin tube gas-charged shocks  | Twin tube gas-charged shocks   | Twin tube gas-charged shocks   |
| TIRES / WHEELS          | Front / Rear Tires<br>Wheels | XPS TrailKing 27 x 9 / 11 x 14 in. 14 in. cast-alum rim   | XPS TrailKing 27 x 9 / 11 x 14 in. 14 in. cast-alum rim  | XPS Trac Force 30 x 9 / 10 x 14 in. 14 in. cast-alum rim   |
| BRAKES                  | Front                        | Dual 220 mm disc brakes with hydraulic twin-piston calipers   | Dual 220 mm disc brakes with hydraulic twin-piston calipers  | Dual 220 mm disc brakes with hydraulic twin-piston calipers  |
|                         | Rear                         | Dual 220 mm disc brakes with hydraulic twin-piston calipers   | Dual 220 mm disc brakes with hydraulic twin-piston calipers  | Dual 220 mm disc brakes with hydraulic twin-piston calipers  |
|                         |                              | N/A   | Brake holding mechanism  | Brake holding mechanism  |
| DIMENSIONS / CAPACITIES | Cage                         | Profiled cage, ROPS approved  | Profiled cage, ROPS approved   | Profiled cage, ROPS approved   |
|                         | Estimated Dry Weight         | 1,953 lb (886 kg)   | 2,077 lb (942 kg)  | 2,434 lb (1,104 kg)  |
|                         | L x W x H                    | 154.1 x 64 x 78 in. (391.5 x 162.5 x 198.1 cm)  | 159.7 x 64 x 80 in. (405.7 x 162.5 x 203.3 cm)   | 159.7 x 65 x 81 in. (405.7 x 165.1 x 228.7 cm)   |
|                         | Wheelbase                    | 115.5 in. (294 cm)  | 115.5 in. (294 cm)   | 115.5 in. (294 cm)   |
|                         | Ground Clearance             | 13 in. (33 cm)  | 13 in. (33 cm)   | 14 in. (35.6 cm)   |
|                         | Cargo Box Dimensions         | 72 x 54.5 x 10 in. (180.3 x 138.4 x 25.4 cm)  | 72 x 54.5 x 10 in. (180.3 x 138.4 x 25.4 cm)   | 72 x 54.5 x 10 in. (180.3 x 138.4 x 25.4 cm)   |
|                         | Cargo Box Capacity           | 1,000 lb (454 kg) / California only: 600 lb (272.2 kg)  | 1,000 lb (454 kg) / California only: 600 lb (272.2 kg)   | 1,000 lb (454 kg) / California only: 600 lb (272.2 kg)   |
|                         | Power Tilt Bed               | N/A   | Hydraulic power tilt bed   | Hydraulic power tilt bed   |
|                         | Tailgate Load Capacity       | 250 lb (113.4 kg)   | 250 lb (113.4 kg)  | 250 lb (113.4 kg)  |
|                         | Storage Capacity             | Total: 10.4 gal (39.5 L)  | Total: 16.9 gal (63.9 L)   | Total: 16.9 gal (63.9 L)   |
|                         | Towing Capacity              | 3,000 lb (1,360.8 kg)   | 3,000 lb (1,360.8 kg)  | 3,000 lb (1,360.8 kg)  |
|                         | Payload Capacity             | 1,700 lb (771 kg)   | 1,570 lb (712 kg)  | 1,200 lb (544 kg)  |
|                         | Fuel Capacity                | 10.6 gal (40 L)   | 10.6 gal (40 L)  | 10.6 gal (40 L)  |
|                         | Person Capacity              | 3   | 3  | 3  |
| FEATURES                | Gauge                        | 4.5 in. wide digital display  | 4.5 in. wide digital display   | 7.6 in. wide digital display with keypad   |
|                         | Battery                      | 12 V (60 amp/h)   | 12 V (60 amp/h)  | 12 V (60 amp/h)  |
|                         | Magneto                      | 650 W   | 650 W  | 850 W  |
|                         | Instrumentation              | DC outlet (10 A)  | DC outlet (10 A), USB port (10 A) x 2  | DC outlet (10 A), USB port (10 A) x 2  |
|                         | Lighting                     | Front lighting output 140 W, LED taillights   | Front lighting output 140 W, LED taillights  | Front lighting output 140 W, LED signature, LED taillights   |
|                         | Winch                        | N/A   | 4,500 lb (2,041 kg) winch with roller fairlead   | 4,500 lb (2,041 kg) winch with roller fairlead   |
|                         | Seat                         | VERSA-PRO bench seat with passenger seats flipping up, underside hooks  | VERSA-PRO bolster bench seats with passenger seats flipping up, adjustable driver's seat, underside hooks, reinforced XT seat skin | VERSA-PRO bolster bench seats with passenger seats flipping up, adjustable driver's seat, underside hooks, reinforced seat skin featuring Lin'ned package trim s   |
|                         | Steering Wheel               | Adjustable tilt steering  | Adjustable tilt steering   | Adjustable tilt steering   |
|                         | Protection                   | Integrated front steel bumper per HMW PE central ski plate  | XT front bumper per HMW PE full ski plate<br>Full hard roof  | XT front bumper per HMW PE full ski plate<br>Full hard roof with liner and interior dome light<br>Full color match doors with electric opening windows<br>3-position full glass tilt-up windshield with wipe/washer kit<br>Rear glass<br>Panorama interior |
|                         | Hitch Type                   | 2 in. hitch receiver  | 2 in. hitch receiver   | 2 in. hitch receiver   |

\*Visco-Lok is a trademark of GKN Visco Drive GmbH.

\*\*Smart-Lok was developed in conjunction with TEAM Industries, a market leader in the drive train industry.

\*\*\*1-year BRP limited warranty. B.E.S.T. term available up to 30 months.







# DEFENDER ACCESSORIES

# BUNDLE UP TOGET IT ALL DONE YOUR DEFENDER BUNDLES

## STEP 1: CHOOSE YOUR ESSENTIAL BUNDLE

|          |                                     | Defender  | Defender MAX | Defender PRO and 6x6           |
|----------|-------------------------------------|-----------|--------------|--------------------------------|
| STARTER  | Sport Roof                          | 715002430 | 715003038    | 715002430                      |
|          | Flip Windshield - Hardcoated        | 715002442 | 715002442    | 715002442                      |
|          | Rear Polycarbonate Window           | 715007081 | 715007081    | 715007081                      |
|          | Side Mirror                         | 715008101 | 715008101    | 715008100                      |
|          | Dash Storage Component Nets         | 715003129 | 715003129    | 715003129                      |
| ADVANCED | LinQ Tailgate Extension/Divider     | 715002464 | 715002464    | 715005412                      |
|          | LinQ Cargo Rack for Long Box        | 715006140 | 715006140    | 715006140                      |
|          | Cargo Bed Protectors & Tie Rails    | N/A       | N/A          | 715005415                      |
|          | LinQ 12 Gal (45 L) Cargo Box        | 715003879 | 715003879    | 715003879                      |
|          | Rear Accessory Bar                  | 715005450 | 715005450    | 715005450                      |
|          | LinQ Adapter                        | 715003058 | 715003058    | 715003058                      |
| PEAK     | Rear View Mirror and Camera Monitor | 715009410 | 715009410    | 715009410                      |
|          | LinQ Tool Holder                    | 715007358 | 715007358    | 715007358                      |
|          | Fender Flares                       | 715006821 | 715006821    | 715005409 6x6<br>715006001 PRO |
|          | Center Underseat Storage Bin        | 715003446 | 715003446    | 715003446                      |

## STEP 2: PICK YOUR ADD-ON BUNDLE

|        |                                    | Defender  | Defender MAX | Defender PRO and 6x6 |
|--------|------------------------------------|-----------|--------------|----------------------|
| AUDIO  | Can-Am Audio Roof                  | 715005206 | N/A          | 715005206            |
|        | Can-Am Audio Roof MAX              | N/A       | 715006879    | N/A                  |
|        | USB Power Outlet Kit               | 219400510 | 219400510    | 219400510            |
|        | Auxiliary Battery Installation Kit | 715006035 | 715006035    | 715006035            |
| HUNT   | Dual Gun Holder                    | 715005265 | 715005265    | 715005265            |
|        | Cargo Bed Window                   | 715006355 | 715006355    | 715006355            |
|        | Rock Sliders                       | 715006671 | 715006721    | 715006721            |
|        | LinQ 8 Gal (30 L) Cooler Box       | 715004778 | 715004778    | 715004778            |
| WORK   | Deluxe Headache Rack               | 715002423 | 715002423    | 715002423            |
|        | LinQ Front Rack                    | 715006064 | 715006064    | 715006064            |
|        | Front Bumper                       | 715005754 | 715005754    | 715005754            |
|        | LinQ Tool & Gun Holder             | 715005466 | 715005466    | 715005466            |
| WINTER | Front Soft Doors                   | 715008059 | 715008059    | 715008059            |
|        | Rear Soft Doors                    | N/A       | 715006318    | N/A                  |
|        | Defrost, Heat & Ventilation System | 715008093 | 715008093    | 715008093            |
|        | Tonneau Cover                      | 715008306 | 715008306    | N/A                  |





|                   |              |           |          |
|-------------------|--------------|-----------|----------|
| <b>Sport Roof</b> | Defender     | 715002430 | \$529.99 |
|                   | DefenderM AX | 715003038 | \$859.99 |



- Robust injection-molded polypropylene construction.
- Provides added protection for rider and passenger from the elements.

|  |              |           |            |
|--|--------------|-----------|------------|
| <b>Deluxe Sport Roof</b><br><i>(Not illustrated)</i> | Defender     | 715002511 | \$1,139.96 |
|  | DefenderM AX | 715003039 | \$1,718.96 |

- Complete roof kit provides extra driver and passenger protection and also diminishes noise within the cab.
  - Perfect fit and finish thanks to the seal kit and the liners included.
  - Rear Roof Liner is not compatible with Soft Rear Panel.
- Includes
- Sport Roof
  - Sport Roof Seal Kit
  - Front Roof Liner
  - Rear Roof Liner

|  |              |           |         |
|--|--------------|-----------|---------|
| <b>Sport Roof Seal Kit</b><br><i>(Not illustrated)</i> | Defender     | 715003126 | \$39.99 |
|  | DefenderM AX | 715003583 | \$38.99 |

- Necessary when installing individual cab components with Sport Roof or when installing the Front and Rear Roof Liners.

|                                   |  |                     |          |
|-----------------------------------|--|---------------------|----------|
| <b>Bimini Roof with Sun Visor</b> | Defender (not compatible for use with soft and rigid full doors) | ■ 715003418 - Black | \$389.99 |
|                                   | DefenderM AX   | ■ 715003030 - Black | \$599.99 |



- Heavy-duty canvas made of UV-resistant polyester.
- Soft top comes with a hard visor that allows for storage of rolled-up soft top and mounting of Light Rack.
- Quick and easy installation.

|                         |                        |           |          |
|-------------------------|------------------------|-----------|----------|
| <b>Front Roof Liner</b> | Defender, DefenderM AX | 715008226 | \$259.99 |
|-------------------------|------------------------|-----------|----------|



- Vehicle enhancement.
- Integrates seamlessly with roof-mounted light switches.
- Required for installation of roof-mounted lights and audio systems.
- Allows a better integration of Windshield Wiper and Washer Kit.
- Seal Kit necessary when installing with Sport Roof.

|                        |                                 |           |          |
|------------------------|---------------------------------|-----------|----------|
| <b>Rear Roof Liner</b> | Defender†                       | 715006334 | \$309.99 |
|                        | DefenderM AX* (Not illustrated) | 715006391 | \$559.99 |



- Quick and easy vehicle enhancement.
- Allows better integration of other accessories installed on the roof.
- Seal Kit necessary when installing with Sport Roof.
- Not compatible with: 715002920, 715006680, 715003249, 715002852.

†Needs to be installed with Sport Roof (715002430).

\*Needs to be installed with Sport Roof (715003038).



## Hard Cabs

|                        |  |                  |                   |
|------------------------|--|------------------|-------------------|
| <b>Clear Rigid Cab</b> | Defender (all model years) (except X m models) | <b>715007269</b> | <b>\$5,199.99</b> |
|                        | Defender MAX 2022 & up (except X m models)     | <b>715007270</b> | <b>\$9,199.99</b> |



- Includes:
  - Front Clear Rigid Doors
  - Sport Roof
  - Flip Glass Windshield
  - Rear Polycarbonate Window
  - Sport Roof Seal Kit

|                                    |                              |   |                   |
|------------------------------------|------------------------------|---|-------------------|
| <b>Premium Rigid Cab Enclosure</b> | Defender (except X m models) | <b>715008607</b>                                      | <b>\$7,099.99</b> |
|                                    |                              | <b>715006330</b> Rear Glass Window with Sliding Panel | <b>\$7,499.99</b> |



- Provides driver and passenger with the best protection from the elements and the cold, and features the most complete top-of-the-line accessories our product lineup has to offer.
- Includes:
  - Deluxe Sport Roof Kit
  - Flip Glass Windshield with Wiper and Washer Kit
  - Full Doors with Power Windows
  - Rear Glass Window
  - Thermal Insulation Kit
  - Wiper and Powered Windows Cable
  - Roof Power Cable
  - Rigid Cab Seal Kit

|                             |   |                  |                    |
|-----------------------------|---|------------------|--------------------|
| <b>Deluxe Cab Enclosure</b> | Defender (all model years) (except X m models)                                      | <b>715007417</b> | <b>\$6,999.99</b>  |
|                             | Defender MAX 2022 & up (models produced after January 18, 2021) (except X m models) | <b>715007425</b> | <b>\$10,199.99</b> |



- Provides driver and passenger with the best protection from the elements and the cold, and features the most complete top-of-the-line accessories our product lineup has to offer.
- Includes:
  - Deluxe Sport Roof Kit
  - Flip Glass Windshield with Wiper and Washer Kit
  - Front Deluxe Full Doors and Color Panels required (sold separately)
  - Rear Glass Window with Sliding Panel
  - Wiper and Powered Windows Cable
  - Roof Power Cable

## Soft Cabs

|   |  |                  |                   |
|---|--|------------------|-------------------|
| <b>Soft Cab Enclosure</b><br><i>(Not illustrated)</i> | Defender (all model years)   | <b>715008063</b> | <b>\$2,469.99</b> |
|   | Defender MAX 2018 & prior, Defender MAX 2022 & up (models produced after January 18, 2021) | <b>715008064</b> | <b>\$3,789.99</b> |

- Included:
- Sport Roof
  - Full Windshield
  - Hardcoated
  - Soft Doors
  - Rear Polycarbonate Window

## Cab Kits Reference Chart

|             | Deluxe Cab Enclosure  | Deluxe Cab Enclosure MAX                                      | Clear Rigid Cab | Clear Rigid Cab MAX | Premium Rigid Cab Enclosure                                   | Premium Rigid Cab Enclosure (Rear Glass Window with sliding panel) | Soft Cab Enclosure | Soft Cab Enclosure MAX |
|-------------|---|---|-----------------|---------------------|---|--|--------------------|------------------------|
| Kit         | 715007417   | 715007425   | 715007269       | 715007270           | 715008607   | 715006330  | 715008063          | 715008064              |
| Windshield  | 715002441   | 715002441   | 715002942       | 715002942           | 715002441   | 715002441  | 715002432          | 715002432              |
| Rear Window | 715007080   | 715007080   | 715007081       | 715007081           | 715007079   | 715007080  | 715007081          | 715007081              |
| Roof        | 715002430   | 715003038   | 715002430       | 715003038           | 715002430   | 715002430  | 715002430          | 715003038              |
| Front Doors | 715005214   | 715005214   | 715006261       | 715006261           | 715006331   | 715006331  | 715008059          | 715008059              |
| Rear Doors  | -   | 715005215   | -               | 715006262           | -   | -  | -                  | 715006318              |
| Others      | 715004462<br>715003094<br>715003126<br>715008226<br>715006334 | 715004462<br>715003094<br>715003583<br>715008226<br>715006391 | 715003126       | 715003583           | 710004462<br>715003094<br>715003126<br>715008226<br>715006334 | 710004462<br>715003094<br>715008226<br>715006334<br>715003126      | -                  | -                      |



# WINDSHIELDS & MIRRORS



## Windshields

|                              |                        |                  |                   |
|------------------------------|------------------------|------------------|-------------------|
| <b>Power Flip Windshield</b> | Defender, Defender MAX | <b>715003885</b> | <b>\$1,599.99</b> |
|------------------------------|------------------------|------------------|-------------------|



- The Power Flip Windshield is equipped with electric cylinders that allow the rider to adjust the windshield opening at the touch of a button.
- Windshield is made of hardcoated polycarbonate with a rubber seal contour and a tinted top section.
- Allows you to quickly adapt to changing conditions by adjusting the windshield as you go.
- Can be fully opened for optimal visibility and ventilation, fully closed for maximum protection from the elements, and in between, you have an infinite number of opening possibilities depending on protection, visibility and air flow preferences.
- Compatible with Can-Am roofs and windshield wiper and washer kit.
- Not EC compliant.

|                              |                        |                  |                   |
|------------------------------|------------------------|------------------|-------------------|
| <b>Flip Glass Windshield</b> | Defender, Defender MAX | <b>715002942</b> | <b>\$1,499.99</b> |
|------------------------------|------------------------|------------------|-------------------|



- Curved and laminated glass full windshield in metal frame.
- Provides excellent optical clarity.
- Seals firmly against the cage and protects rider and passenger from the elements while allowing for controlled airflow.
- 3-position flip can be set at fully closed, ¼ open, or fully open.
- Gas-shock-assisted operation and pivots on 2 hinges located at the top of the windshield.
- Ideal for muddy conditions.
- Can be used with Windshield Wiper & Washer Kit (715001638).
- Not EC compliant.

|  |                        |                  |                   |
|--|------------------------|------------------|-------------------|
| <b>Flip Glass Windshield With Wiper &amp; Washer Kit</b> | Defender, Defender MAX | <b>715002441</b> | <b>\$2,099.99</b> |
|--|------------------------|------------------|-------------------|



- Curved and laminated glass full windshield in metal frame.
- Provides excellent optical clarity.
- Seals firmly against the cage and protects rider and passenger from the elements while allowing for controlled airflow.
- Flip windshield can be set fully closed or fully open according to your preference.
- Ideal for muddy conditions.
- Gas-shock-assisted operation and pivots on 2 hinges located at the top of the windshield.
- Single-speed wiper with washer fluid dispenser.
- Requires Wiper and Power Cables: If equipped with the Sport Roof Power Cables 710004462 & 715003094 are required. If equipped with the Audio Roof Power Cables 715008781 & 715003094 are required.
- Not EC compliant.

|                                     |                        |                  |                   |
|-------------------------------------|------------------------|------------------|-------------------|
| <b>Flip Windshield – Hardcoated</b> | Defender, Defender MAX | <b>715002442</b> | <b>\$1,099.99</b> |
|-------------------------------------|------------------------|------------------|-------------------|



- High-impact-resistant Makrolon® hardcoated polycarbonate full windshield in metal frame.
- Provides excellent optical clarity and better abrasion resistance.
- Seals firmly against the cage and protects rider and passenger from the elements while allowing for controlled airflow.
- 3-position flip can be set at fully closed, ¼ open, or fully open.
- Gas-shock-assisted operation.
- Ideal for muddy conditions.

|                         |                        |                  |                   |
|-------------------------|------------------------|------------------|-------------------|
| <b>Glass Windshield</b> | Defender, Defender MAX | <b>715001303</b> | <b>\$1,119.99</b> |
|-------------------------|------------------------|------------------|-------------------|



- Curved and laminated glass full windshield in metal frame.
- Seals firmly against the cage and protects rider and passenger from the elements while providing excellent optical clarity.
- Must be used with Windshield Wiper & Washer Kit (715001638) to maintain clear visibility during severe riding conditions.
- Not EC compliant.

|                                     |                        |                  |                 |
|-------------------------------------|------------------------|------------------|-----------------|
| <b>Full Windshield – Hardcoated</b> | Defender, Defender MAX | <b>715002432</b> | <b>\$659.99</b> |
|-------------------------------------|------------------------|------------------|-----------------|



- High-impact-resistant Makrolon® hardcoated polycarbonate full windshield.
- Provides excellent optical clarity and better abrasion resistance.
- Protects driver and passenger from the elements.
- Quick and easy tool-less installation or removal.

|                        |                        |                  |                 |
|------------------------|------------------------|------------------|-----------------|
| <b>Full Windshield</b> | Defender, Defender MAX | <b>715002431</b> | <b>\$439.99</b> |
|------------------------|------------------------|------------------|-----------------|



- High-impact-resistant durable polycarbonate full windshield.
- Formulated to be non-yellowing, non-crazing, non-cracking with excellent UV resistance and optical clarity.
- Protects driver and passenger from the elements.
- Quick and easy tool-less installation or removal.

|                        |                       |           |          |
|------------------------|-----------------------|-----------|----------|
| <b>Half Windshield</b> | Defender, DefenderMAX | 715002433 | \$299.99 |
|------------------------|-----------------------|-----------|----------|



- High-impact-resistant durable polycarbonate half windshield.
- Formulated to be non-yellowing, non-crazing, non-cracking with excellent UV resistance and optical clarity.
- Protects driver and passenger from the elements.
- Features reverse angle lip to deflect air flow.
- Quick and easy tool-less installation or removal.
- Not compatible with Soft Doors.

|                           |                       |           |          |
|---------------------------|-----------------------|-----------|----------|
| <b>ProVent Windshield</b> | Defender, DefenderMAX | 715005276 | \$909.99 |
|---------------------------|-----------------------|-----------|----------|



- High-impact-resistant Quantum hardcoated polycarbonate full windshield.
- Optimized performance with Full Cab Enclosure.
- Controllable vents to manage air flow.
- Channels air into the cabin, defogs windshield, fully closes to eliminate air flow.
- 2 lower vents and one upper vent (pre-filter installed).
- Provides excellent optical clarity and better abrasion resistance.
- Protects driver and passenger from the elements.
- Quick and easy tool-less installation or removal.
- Not compatible with perks.

|  |                       |           |          |
|--|-----------------------|-----------|----------|
| <b>Windshield Wiper &amp; Washer Kit</b> | Defender, DefenderMAX | 715001638 | \$699.99 |
|--|-----------------------|-----------|----------|



- An ideal way to keep your windshield clear in rain, or while riding through mud and water.
- Includes single-speed wiper, washer fluid dispenser and windshields frame mount.
- Must be used with the Glass Windshield (715001303) or Flip Glass Windshield (715002942) or Powerflip Windshield (715003885).
- Requires Wiper and Power Cables: If equipped with the Sport Roof, Power Cables 710004462 & 715003094 are required. If equipped with the Audio Roof, Power Cables 715008781 & 715003094 are required. Not EC compliant.

|   |                       |           |         |
|---|-----------------------|-----------|---------|
| <b>Wiper &amp; Power Window Cable</b><br><i>(Not illustrated)</i> | Defender, DefenderMAX | 715008781 | \$75.99 |
|---|-----------------------|-----------|---------|

- Required to install the Audio Roof (715005206 or 715006879) with the following accessories: Flip Glass Windshield with Wiper & Washer Kit (715002441), Windshield Wiper & Washer Kit (715001638), Front Full Doors with Power Windows (715006331).

|  |                       |           |          |
|--|-----------------------|-----------|----------|
| <b>Wiper &amp; Power Windows Cable</b><br><i>(Not illustrated)</i> | Defender, DefenderMAX | 710004462 | \$269.99 |
|--|-----------------------|-----------|----------|

- Required to install Full Doors with Power Windows (715006331) and/or Windshield Wiper & Washer Kit (715001638).
- Necessary if you want to build your own cab enclosure from modular components.

|                             |                       |           |          |
|-----------------------------|-----------------------|-----------|----------|
| <b>NEW Manual Wiper Kit</b> | Defender, DefenderMAX | 715008755 | \$119.99 |
|-----------------------------|-----------------------|-----------|----------|



- Single manual wiper that can be used to clear windshield of debris.
- Easy to install system that requires no electrical hookup.
- Large ergonomic handle provides a good grip over the entire sweeping surface.
- Compatible with glass and hardcoated windshields that use top mounted wipers.

|                             |                       |           |          |
|-----------------------------|-----------------------|-----------|----------|
| <b>Side Wind Deflectors</b> | Defender, DefenderMAX | 715005081 | \$219.99 |
|-----------------------------|-----------------------|-----------|----------|



- Clear polycarbonate air deflectors mount on each side of the cage.
- Not compatible with Full Doors.
- Sold in pairs.
- Compatible with all windshields.
- Can be adjusted at three different positions for cabin air flow control when a full windshield is installed:
  1. Outside deflection to reduce cabin air flow and turbulence.
  2. Inside deflection to increase air flow in the cabin.
  3. Windshield ventilation to reduce fog.

## Mirrors

|                     |                       |                  |          |
|---------------------|-----------------------|------------------|----------|
| <b>Side Mirrors</b> | Defender, DefenderMAX | 715008100 -Black | \$219.99 |
|---------------------|-----------------------|------------------|----------|



- Rugged black nylon 6/6 construction with coated cast-aluminum mount.
- Dual adjustment (horizontal and vertical) will suit any rider.
- Convex optics deliver optimal field of view (FOV).
- Spring-loaded pivots let mirrors fold back completely.
- Fits in and without doors and half doors.
- Sold in pairs.



|                    |                                       |                   |                 |
|--------------------|---------------------------------------|-------------------|-----------------|
| <b>Side Mirror</b> | Defender, Defender MAX (2022 & up)    | <b>715008101*</b> | <b>\$139.99</b> |
|                    | Defender, Defender MAX (2021 & prior) | <b>715002459</b>  | <b>\$119.99</b> |



- Molded heavy-duty aluminum mirror.
- Stays in place on rough trails.
- Ball-joint design for steady multi-angle adjustment and outstanding vision.
- Use with or without any roof, windshield or doors.

- Not for road use.
- Fits either side.
- Sold individually.

\*Not compatible with the Half Doors (715006314 & 715006316).

|  |                        |                  |                 |
|--|------------------------|------------------|-----------------|
| <b>Rear View Mirror &amp; Camera Monitor</b> | Defender, Defender MAX | <b>715009410</b> | <b>\$499.99</b> |
|--|------------------------|------------------|-----------------|



- Fully waterproof rearview mirror and monitor kit.
- See exactly what you need to see with the multiple camera feeds from the rearview camera.
- This unit replaces the stock rearview mirror (the screen is integrated in the unit's replacement rearview mirror).
- The camera uses infrared light for night vision capabilities.

|                                |                        |                  |                |
|--------------------------------|------------------------|------------------|----------------|
| <b>Panoramic Center Mirror</b> | Defender, Defender MAX | <b>715003638</b> | <b>\$99.99</b> |
|--------------------------------|------------------------|------------------|----------------|



- Wide-angle convex mirror.
- Offers enhanced visibility.
- Can be used with or without roof or windshield and with cab enclosures.

# REAR WIND PROTECTION

|   |  |                  |                 |
|---|--|------------------|-----------------|
| <b>Rear Glass Window with Sliding Panel</b> | Defender, Defender MAX (except Xtrim models) | <b>715007080</b> | <b>\$899.99</b> |
|---|--|------------------|-----------------|



- Made of high-strength tempered glass.
- Ideal for preventing backdraft of dust or rain in harsh environments.
- Sliding panel for enhanced ventilation.
- Quick and easy installation.

- Sport Roof (715002430 or 715003038) required for installation.
- Not compatible with Snorkel Kit.

|                          |  |                  |                 |
|--------------------------|--|------------------|-----------------|
| <b>Rear Glass Window</b> | Defender, Defender MAX (except Xtrim models) | <b>715007079</b> | <b>\$589.99</b> |
|--------------------------|--|------------------|-----------------|



- Made of high-strength tempered glass.
- Ideal for preventing backdraft of dust or rain in harsh environments.
- Quick and easy installation.

- Sport Roof (715002430 or 715003038) required for installation.
- Not compatible with Snorkel Kit.

|                                  |  |                  |                 |
|----------------------------------|--|------------------|-----------------|
| <b>Rear Polycarbonate Window</b> | Defender, Defender MAX (except Xtrim models) | <b>715007081</b> | <b>\$459.99</b> |
|----------------------------------|--|------------------|-----------------|



- High-impact resistant polycarbonate window.
- Ideal for preventing backdraft of dust or rain in harsh environments.
- Quick and easy installation.

- Sport Roof (715002430 or 715003038) required for installation.
- Not compatible with Snorkel Kit.

|                         |                        |                  |                 |
|-------------------------|------------------------|------------------|-----------------|
| <b>Rear Wind Screen</b> | Defender, Defender MAX | <b>715002851</b> | <b>\$129.99</b> |
|-------------------------|------------------------|------------------|-----------------|



- Full rear mesh screen reduces windshield backdraft for added cabin comfort.
- Installs quick and easily on roll cage.
- White Can-Am logo at top, to help maintain clear view.

|                         |                        |                  |                 |
|-------------------------|------------------------|------------------|-----------------|
| <b>Soft Rear Window</b> | Defender, Defender MAX | <b>715003249</b> | <b>\$139.99</b> |
|-------------------------|------------------------|------------------|-----------------|



- Clear, flexible window made of see-through vinyl.
- Resists cold cracking to -4°F (-20°C).
- Blocks windshield backdraft or dust and rain from entering, for added cabin comfort.

- Installs quick and easily on roll cage.
- White Can-Am logo at top, to help maintain clear view.



|                                |   |                  |                   |
|--------------------------------|---|------------------|-------------------|
| <b>Front Deluxe Full Doors</b> | Defender (all model years) (except Xmr models), Defender M AX (all model years) (except Xmr models) | <b>715005214</b> | <b>\$3,899.99</b> |
|--------------------------------|---|------------------|-------------------|



- Premium doors made from robust polyethylene.
- Offer excellent protection from the elements.
- Easy to remove on hot and sunny days.
- Convenient integrated storage areas.
- Doors' curved design provides even more room.
- Rear hinge wide opening for ease of ingress/egress in the cockpit.
- Power window delivers added ventilation.
- Compatible with all BRP windshield kits.
- Require Window & Power Windows Cable (710004462), Roof Power Cable (715003094) and Seal Kit (715003126).
- Cobra Door Trims are required (sold separately).
- Hardware to install the Door Trim is included.

|                               |  |                  |                   |
|-------------------------------|--|------------------|-------------------|
| <b>Rear Deluxe Full Doors</b> | Defender M AX 2022 & up (models produced after January 18, 2021) (except Xmr models) | <b>715005215</b> | <b>\$3,629.99</b> |
|-------------------------------|--|------------------|-------------------|



- Premium doors made from robust polyethylene.
- Offer excellent protection from the elements.
- Easy to remove on hot and sunny days.
- Convenient integrated storage areas.
- Curved design provides even more room.
- Rear hinge opens wide for ease of ingress/egress in the cockpit.
- Roll Down Window delivers added ventilation.
- Require Front Doors (715005214), Window and Power Window Cables (710004462), Power Cable (715003094) and Sport Roof Seal Kit (715003583).
- Cobra Door Trims are required (sold separately).
- Hardware to install the Door Trim is included.

|                                |   |                  |                   |
|--------------------------------|---|------------------|-------------------|
| <b>Front Deluxe Half Doors</b> | Defender (all model years), Defender M AX 2022 & up | <b>715007201</b> | <b>\$2,409.99</b> |
|--------------------------------|---|------------------|-------------------|



- Premium cobra matching doors made from robust polyethylene.
- Premium fit and finish.
- Slim with interior pockets.
- Rear hinge wide opening for ease of ingress/egress in the cockpit.
- Interior and exterior handles.
- Cobra accent panels are required (sold separately).
- Hardware to install the Door Trim is included.

|                               |                         |                  |                   |
|-------------------------------|-------------------------|------------------|-------------------|
| <b>Rear Deluxe Half Doors</b> | Defender M AX 2022 & up | <b>715007202</b> | <b>\$2,409.99</b> |
|-------------------------------|-------------------------|------------------|-------------------|



- Premium cobra matching doors made from robust polyethylene.
- Premium fit and finish.
- Slim with interior pockets.
- Rear hinge wide opening for ease of ingress/egress in the cockpit.
- Interior and exterior handles.
- Cobra accent panels are required (sold separately).
- Hardware to install the Door Trim is included.

|                    |   |                 |
|--------------------|---|-----------------|
| <b>Front Trims</b> | Front Deluxe Full Doors & Front Deluxe Half Doors | <b>\$219.99</b> |
|--------------------|---|-----------------|



- Customize your Defender by adding cobra matched door panels.
- Front Deluxe Full Doors (715005214) or Front Deluxe Half Doors (715007201) are required.

**Front Left Door Trim**

- **705800818** - Liquid Titanium
- **705800784** - Stone Gray
- **705800810** - Oxford Blue
- **705800814** - Tundra Green
- **705800812** - Timeless Black
- **705801118** - Wildland Camo **NEW**
- **705801114** - Fiery Red **NEW**

**Front Right Door Trim**

- **705800819** - Liquid Titanium
- **705800785** - Stone Gray
- **705800811** - Oxford Blue
- **705800815** - Tundra Green
- **705800813** - Timeless Black
- **705801119** - Wildland Camo **NEW**
- **705801115** - Fiery Red **NEW**

|   |  |                         |                          |   |   |
|---|--|-------------------------|--------------------------|---|---|
| <b>Rear Trims</b>   | RearDeluxe FullDoors & RearDeluxe HalfDoors  | <b>\$214.99</b>         |                          |   |   |
|    | <ul style="list-style-type: none"> <li>• Customize your Defender by adding color-matched door panels.</li> <li>• RearDeluxe FullDoors (715005215) or RearDeluxe HalfDoors (715007202) are required.</li> </ul>   |                         |                          |   |   |
|   | <table border="0"> <tr> <td><b>RearLeftDoorTrim</b></td> <td><b>RearRightDoorTrim</b></td> </tr> <tr> <td> <ul style="list-style-type: none"> <li>■ <b>705800832</b> ·Liquid Titanium</li> <li>■ <b>705800820</b> ·Stone Gray</li> <li>■ <b>705800822</b> ·Oxford Blue</li> <li>■ <b>705800826</b> ·Tundra Green</li> <li>■ <b>705800824</b> ·Titanless Black</li> <li>■ <b>705801120</b> ·Wildland Camo <b>NEW</b></li> <li>■ <b>705801116</b> ·Fiery Red <b>NEW</b></li> </ul> </td> <td> <ul style="list-style-type: none"> <li>■ <b>705800833</b> ·Liquid Titanium</li> <li>■ <b>705800821</b> ·Stone Gray</li> <li>■ <b>705800823</b> ·Oxford Blue</li> <li>■ <b>705800827</b> ·Tundra Green</li> <li>■ <b>705800825</b> ·Titanless Black</li> <li>■ <b>705801121</b> ·Wildland Camo <b>NEW</b></li> <li>■ <b>705801117</b> ·Fiery Red <b>NEW</b></li> </ul> </td> </tr> </table> | <b>RearLeftDoorTrim</b> | <b>RearRightDoorTrim</b> | <ul style="list-style-type: none"> <li>■ <b>705800832</b> ·Liquid Titanium</li> <li>■ <b>705800820</b> ·Stone Gray</li> <li>■ <b>705800822</b> ·Oxford Blue</li> <li>■ <b>705800826</b> ·Tundra Green</li> <li>■ <b>705800824</b> ·Titanless Black</li> <li>■ <b>705801120</b> ·Wildland Camo <b>NEW</b></li> <li>■ <b>705801116</b> ·Fiery Red <b>NEW</b></li> </ul> | <ul style="list-style-type: none"> <li>■ <b>705800833</b> ·Liquid Titanium</li> <li>■ <b>705800821</b> ·Stone Gray</li> <li>■ <b>705800823</b> ·Oxford Blue</li> <li>■ <b>705800827</b> ·Tundra Green</li> <li>■ <b>705800825</b> ·Titanless Black</li> <li>■ <b>705801121</b> ·Wildland Camo <b>NEW</b></li> <li>■ <b>705801117</b> ·Fiery Red <b>NEW</b></li> </ul> |
| <b>RearLeftDoorTrim</b>   | <b>RearRightDoorTrim</b>   |                         |                          |   |   |
| <ul style="list-style-type: none"> <li>■ <b>705800832</b> ·Liquid Titanium</li> <li>■ <b>705800820</b> ·Stone Gray</li> <li>■ <b>705800822</b> ·Oxford Blue</li> <li>■ <b>705800826</b> ·Tundra Green</li> <li>■ <b>705800824</b> ·Titanless Black</li> <li>■ <b>705801120</b> ·Wildland Camo <b>NEW</b></li> <li>■ <b>705801116</b> ·Fiery Red <b>NEW</b></li> </ul> | <ul style="list-style-type: none"> <li>■ <b>705800833</b> ·Liquid Titanium</li> <li>■ <b>705800821</b> ·Stone Gray</li> <li>■ <b>705800823</b> ·Oxford Blue</li> <li>■ <b>705800827</b> ·Tundra Green</li> <li>■ <b>705800825</b> ·Titanless Black</li> <li>■ <b>705801121</b> ·Wildland Camo <b>NEW</b></li> <li>■ <b>705801117</b> ·Fiery Red <b>NEW</b></li> </ul>  |                         |                          |   |   |

|   |  |                  |                   |
|---|--|------------------|-------------------|
| <b>Front Clear Rigid Doors</b>  | Defender (all model years) (except X m r models), DefenderM AX 2022 & up (except X m r models)   | <b>715006261</b> | <b>\$3,249.99</b> |
|  | <ul style="list-style-type: none"> <li>• Sturdy and compact steel frame doors for a robust yet open field of view.</li> <li>• Lower hardcoated polycarbonate transparent panel maximizes visibility around your unit.</li> <li>• Upper portion composed of two tempered-glass sliding windows for unattached air circulation and versatility.</li> <li>• EC- and ROHVA-compliant for optimal safety, allowing you to remove the stock side protection bar for increased cabin space.</li> <li>• Sealed contours allow for improved rider comfort in all weather.</li> <li>• Lockable doors for peace of mind.</li> </ul> |                  |                   |

|  |  |                  |                   |
|--|--|------------------|-------------------|
| <b>Rear Clear Rigid Doors</b>  | Defender (all model years) (except X m r models), DefenderM AX 2022 & up (except X m r models)   | <b>715006262</b> | <b>\$3,249.99</b> |
|  | <ul style="list-style-type: none"> <li>• Sturdy and compact steel frame doors for a robust yet open field of view.</li> <li>• Lower hardcoated polycarbonate transparent panel maximizes visibility around your unit.</li> <li>• Upper portion composed of two tempered-glass sliding windows for unattached air circulation and versatility.</li> <li>• EC- and ROHVA-compliant for optimal safety, allowing you to remove the stock side protection bar for increased cabin space.</li> <li>• Sealed contours allow for improved rider comfort in all weather.</li> <li>• Lockable doors for peace of mind.</li> </ul> |                  |                   |

|   |  |                  |                   |
|---|--|------------------|-------------------|
| <b>Front Full Doors with Power Windows</b>  | Defender & DefenderM AX produced before January 18, 2021   | <b>715006331</b> | <b>\$4,399.99</b> |
|  | <ul style="list-style-type: none"> <li>• Made from robust high-density polyethylene.</li> <li>• Offers excellent protection from the elements.</li> <li>• Easy to remove on hot and sunny days.</li> <li>• Lockable doors with convenient integrated storage areas.</li> <li>• Doors' curved design provides even more roominess. Rear hinge wide opening for ease of ingress/egress in the cockpit.</li> <li>• Power window delivers added ventilation.</li> <li>• Compatible with all BRP windshield.</li> <li>• Requires Window &amp; Power Cables and Seal Kit. If equipped with the Sport Roof, Power Cables 710004462 &amp; 715003094 and Seal Kit 715003126 are required. If equipped with the Audio Roof, Power Cables 715008781 &amp; 715003094 and Seal Kit 715003126 are required.</li> </ul> |                  |                   |

|   |   |                  |                   |
|---|---|------------------|-------------------|
| <b>Half Doors</b>   | Defender (2 doors)  | <b>715006314</b> | <b>\$1,079.99</b> |
|   | DefenderM AX (4 doors)  | <b>715006316</b> | <b>\$1,809.99</b> |
|  | <ul style="list-style-type: none"> <li>• Half doors made of plastic.</li> <li>• Metal frame for a higher level of fit and finish and rigidity.</li> <li>• Rear hinge wide opening for ease of ingress/egress in the cockpit.</li> <li>• Interior pockets and liners for more protection.</li> </ul> |                  |                   |

|   |  |                                 |                   |
|---|--|---------------------------------|-------------------|
| <b>Soft Doors</b>   | Defender, DefenderM AX (all model years)   | <b>715008059</b> ·2 front doors | <b>\$1,269.99</b> |
|   | DefenderM AX 2018 & prior, DefenderM AX 2022 & up (models produced after January 18, 2021)   | <b>715006318</b> ·2 rear doors  | <b>\$1,159.99</b> |
|  | <ul style="list-style-type: none"> <li>• Best designed soft doors for Can-Am Defender.</li> <li>• Weather-resistant soft doors reinforced with steel frame offer good protection from the elements.</li> <li>• Made of heavy-duty UV-resistant canvas for excellent resistance to tear and abrasion.</li> <li>• Rear hinge wide opening for ease of ingress/egress.</li> <li>• Zip-down window made of laminated polished vinyl material for added ventilation.</li> <li>• Easily removable on hot sunny days.</li> <li>• Compatible with roofs and mirrors.</li> <li>• Soft Door Installation Kit (715006238/2X for M AX) is required for installation of 2019 &amp; prior doors, on 2020 Defender models.</li> </ul> |                                 |                   |



# SEAT ACCESSORIES



## Central Headrest

Defender, Defender MAX

715005163

\$159.99



- Headrest for front-center seating position on 3-seated models and for rear-center seating position on MAX models.
- Front Headrests are available separately for front passengers on MAX models.
- Headrests are required for all passengers on some regulated trails.
- Not EC compliant.

*Headrests are required for all passengers on some regulated trails.*

## Front Headrests

Defender MAX

715005164

\$239.99



- Additional headrest for all three front seating positions on MAX models.
- Central Headrest is available separately for rear-center seating positions on MAX models.
- Headrests are required for all passengers on some regulated trails.
- Not EC compliant.

*Headrests are required for all passengers on some regulated trails.*

# ALUMINUM SKID PLATES

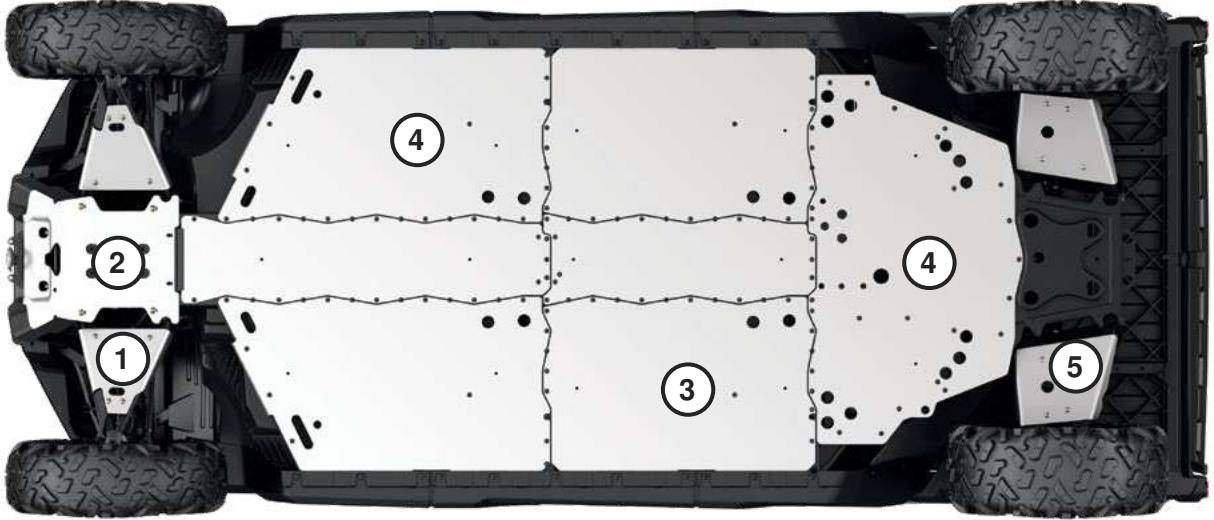

For ultimate durability and strength, all our Aluminum Skid Plates are made with High Strength 5052 H32 Aluminum / " (4.5 mm) thick.

- Ultimate durability
- High strength

## DEFENDER DEFENDERMAX

|   | 2019 & prior   |   | 2020 & up   |   |   |
|---|--|---|---|---|---|
| Order your Defender the full protection kit or get parts individually | Base, DPS, XT, XT-P, XT Cab 2017 & prior & Hunting Edition | XT Cab 2018-2019, Lone Star Edition & Xmr | 62"<br>Base, DPS (HD 5, HD 7, HD 8 & HD 9), XT (HD 7, HD 8 & HD 9) & PRO (HD 8) | 64"<br>6x6 DPS & XT) or Pro (DPS, XT), XT PRO, DPS (HD 10), XT (HD 10) & XT-P | 67"<br>XT Cab, Hunting Edition, Lone Star Edition, Limited, & Xmr |

### Full Protection Kit

|                                    |                        |                  |                        |                        |                                    |
|------------------------------------|------------------------|------------------|------------------------|------------------------|------------------------------------|
| Aluminum Skid Plate Protection Kit | 715003711 (except MAX) | 715006977 (3-up) | 715006694 (except MAX) | 715006696 (3-up & 6x6) | 715006979 (3-up 2020 to 2021 only) |
|                                    | 715003712 (MAX only)   | 715006978 (MAX)  | 715006695 (MAX only)   | 715006697 (MAX & PRO)  | 715006980 (MAX 2020 to 2021 only)  |

### Individual Aluminum Skid Plates

|   |                      |                      |                      |                      |  |
|---|----------------------|----------------------|----------------------|----------------------|--|
| <b>① Front A-Arm Protectors</b> <ul style="list-style-type: none"> <li>• Extra underside protection for your vehicle's steering mechanism and suspension (A-arm).</li> <li>• Sold in pairs.</li> <li>• Not compatible with Apache Track Systems.</li> </ul>   | 715008274            | 715006975            | 715008274            | 715008275            | 715008275 (2022 & up)<br>715006975 (2020 to 2021 only) |
| <b>② Front Skid Plate</b> <ul style="list-style-type: none"> <li>• Protects the front underside of your vehicle when riding in rough terrain conditions.</li> <li>• Adds style to the front of your vehicle.</li> </ul>   | 715002447            | 715002447            | 715002447            | 715002447            | 715002447  |
| <b>③ Central Skid Plate</b> <p>Central Skid Plate Kit includes central and lateral skid plates.</p> <ul style="list-style-type: none"> <li>• Ultra-durable protection for the underside of your vehicle.</li> <li>• Makes work easy in more demanding terrain.</li> <li>• Must be used with Underbelly Skid Plate Kit.</li> </ul> | 715003467 (MAX only) | 715003467 (MAX only) | 715003467 (MAX only) | 715003467 (MAX only) | 715003467 (MAX only)                                   |
| <b>④ Underbelly Skid Plate Kit</b> <ul style="list-style-type: none"> <li>• Ultra-durable protection for the underside of your vehicle.</li> <li>• Makes work easy in more demanding terrain.</li> <li>• Kit includes central, lateral and rear skid plates.</li> </ul>   | 715002446            | 715002446            | 715007982            | 715007982            | 715007982  |
| <b>⑤ Rear A-Arm Protectors</b> <ul style="list-style-type: none"> <li>• Extra underside protection for your vehicle's suspension (A-arm).</li> <li>• Sold in pairs.</li> <li>• Not compatible with Apache Track Systems.</li> </ul>   | 715002445            | 715006976            | 715002445            | 715004388            | 715004388 (2022 & up)<br>715006976 (2020 to 2021 only) |

# BUMPERS & GUARDS





## Bumpers

|  |  |   |                 |
|--|--|---|-----------------|
| <b>Front Bumper</b>  | Defender, Defender MAX (2019 & prior)  | <b>715002418</b>  | <b>\$329.99</b> |
|  | Defender, Defender MAX (2020 & up)   | <b>715005754</b>  |                 |
|  | <ul style="list-style-type: none"> <li>Heavy-duty 1.5" (3.8 cm) diameter steel tube construction.</li> <li>Provides enhanced protection.</li> <li>Inside and outside anti-corrosion coating with durable powdercoat finish.</li> </ul> | <ul style="list-style-type: none"> <li>Integrated mounting points for lights.</li> <li>Required to install the Xtreme Front Bumper Plates, Front Rack and the Front Corner Protectors.</li> </ul> |                 |

|  |  |   |                 |
|--|--|---|-----------------|
| <b>Xtreme Front Bumper Plates</b>  | Defender, Defender MAX (2019 & prior)  | <b>715003005</b>  | <b>\$319.99</b> |
|  | Defender, Defender MAX (2020 & up)   | <b>715005777</b>  | <b>\$294.99</b> |
|  | <ul style="list-style-type: none"> <li>Made of high-strength heavy-gauge steel with rubberpads for increased protection.</li> <li>Inside and outside anti-corrosion coating with durable powdercoat finish.</li> <li>Provide additional front-end protection.</li> </ul> | <p><i>†Require Front Bumper (715002418) for installation.</i></p> <p><i>‡Require Front Bumper (715005754) for installation.</i></p> |                 |

|  |  |   |                 |
|--|--|---|-----------------|
| <b>Front Corner Protectors</b>   | Defender, Defender MAX (2019 & prior)  | <b>715002833</b>  | <b>\$229.99</b> |
|  | Defender, Defender MAX (2020 & up)   | <b>715005774</b>  |                 |
|  | <ul style="list-style-type: none"> <li>Heavy-duty 1.25" (3.2 cm) diameter steel tube construction.</li> <li>Provide enhanced protection for front corners.</li> <li>Inside and outside anti-corrosion coating with durable powdercoat finish.</li> <li>Sold in pairs.</li> </ul> | <p><i>†Require Front Bumper (715002418) for installation.</i></p> <p><i>‡Require Front Bumper (715005754) for installation.</i></p> |                 |

|  |  |  |                 |
|--|--|--|-----------------|
| <b>Rancher Front Bumper</b>  | Defender, Defender MAX   | <b>715005410</b>   | <b>\$679.99</b> |
|  |  |  |                 |
|  | <ul style="list-style-type: none"> <li>The low front-end protection and plates allow you to use your vehicle with cattle herds and guard the safety of both the vehicle and the animals.</li> <li>The flat front portion facilitates gently prodding cattle or pushing light objects, e.g., closing a fence.</li> <li>The full frontage coverage extends to provide an extra layer of defense to your headlights and radiator.</li> <li>Inside and outside anti-corrosion coating with durable powdercoat finish.</li> </ul> | <p><u>Defender, Defender MAX (2020 &amp; up)</u></p> <ul style="list-style-type: none"> <li>Improved approach angle.</li> <li>Compatible with front rack, snow plows, tire and track kits, winches.</li> </ul> |                 |

|  |  |  |                 |
|--|--|--|-----------------|
| <b>XT Front Bumper</b>   | Defender, Defender MAX (2019 & prior)  | <b>715004407</b>   | <b>\$199.99</b> |
|  |  |  |                 |
|  | <ul style="list-style-type: none"> <li>1.5" (3.8 cm) diameter steel tube construction.</li> <li>Provides light-duty protection.</li> <li>Inside and outside anti-corrosion coating with durable powdercoat finish.</li> <li>Light-kit compatible.</li> </ul> | <ul style="list-style-type: none"> <li>Standard on XT and XT Cab models 2018 and 2019.</li> <li>Not compatible with Xtreme Front Bumper Plates, Front Corner Protectors or LinQ Front Rack.</li> </ul> |                 |

|  |   |   |                 |
|--|---|---|-----------------|
| <b>Xmr Front Bumper</b>  | Defender, Defender MAX  | <b>715006143 -Black</b>   | <b>\$329.99</b> |
|  |   |   |                 |
|  | <ul style="list-style-type: none"> <li>Heavy-duty 1.5" (3.8 cm) diameter steel tube construction.</li> <li>Inside and outside anti-corrosion coating with durable finish.</li> <li>Provides additional front body protection.</li> <li>Integrated winch support plate for winch retraction at a higher position for easier access in muddy conditions or for auxiliary lights.</li> </ul> | <ul style="list-style-type: none"> <li>Includes a front tow hook.</li> <li>Standard on Xmr models.</li> <li>Winch sold separately.</li> </ul> |                 |



|   |                           |           |          |
|---|---------------------------|-----------|----------|
| <b>Cargo Bed Protectors &amp; Tie Rails</b> | Defender 6x6 & PRO models | 715005415 | \$329.99 |
|---|---------------------------|-----------|----------|

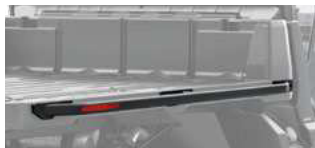

- Heavy-duty 1.5" (3.8 cm) diameter steel tube construction.
- Reliable cargo box protection and tie-down attachment point to secure large loads.
- Anti-corrosion coating with durable powdercoat finish.
- Designed to stay in place when cargo bed side walls are removed.

|                    |                        |           |          |
|--------------------|------------------------|-----------|----------|
| <b>Rear Bumper</b> | Defender, Defender MAX | 715008109 | \$299.99 |
|--------------------|------------------------|-----------|----------|



- Heavy-duty 1.5" (3.8 cm) diameter steel construction and integrated tubular design.
- Increased protection of rear box and lower box corner while allowing normal tailgate function.
- Inside and outside anti-corrosion coating with durable powdercoat finish.
- Required to install Rear Body Side Protector (715003055).

|  |                           |           |         |
|--|---------------------------|-----------|---------|
| <b>Rear Bumper Adapter</b><br><i>(Not illustrated)</i> | Defender 6x6 & PRO models | 715006060 | \$49.99 |
|--|---------------------------|-----------|---------|

- Required to install the Rear Bumper on Defender models with the long box.

|                                  |   |           |          |
|----------------------------------|---|-----------|----------|
| <b>Rear Body Side Protectors</b> | Defender, Defender MAX (except 6x6 & PRO) | 715003055 | \$209.99 |
|----------------------------------|---|-----------|----------|



- Heavy-duty 1.5" (3.8 cm) diameter steel tube construction.
- Reliable cargo box protection.
- Inside and outside anti-corrosion coating with durable powdercoat finish.
- Compatible with fender flares.
- Integrated brush and low-lying branch deflector.
- Require Rear Bumper for installation.
- Sold in pairs.

## Body Side Protectors

|                                   |                        |           |          |
|-----------------------------------|------------------------|-----------|----------|
| <b>Front Body Side Protectors</b> | Defender, Defender MAX | 715003450 | \$159.99 |
|-----------------------------------|------------------------|-----------|----------|



- Heavy-duty 1.25" (3.2 cm) diameter steel tube construction.
- Frontside protection for farm, ranch and forestry applications.
- Offer complete frontbody protection.
- Inside and outside anti-corrosion coating with durable powdercoat finish.
- Sold in pairs.
- Require Front Bumper (715002418 or 715005754) with Front Corner Protectors (715002833 or 715005774) and Rock Slider (715002569 or 715003040 for MAX models) for installation.

|   |                        |           |          |
|---|------------------------|-----------|----------|
| <b>Front Rancher Body Side Protectors</b> | Defender, Defender MAX | 715003617 | \$159.99 |
|---|------------------------|-----------|----------|



- Heavy-duty 1.25" (3.2 cm) diameter steel tube construction.
- Frontside protection for farm, ranch and forestry applications.
- Offer complete frontbody protection.
- Inside and outside anti-corrosion coating with durable powdercoat finish.
- Sold in pairs.
- Require Rancher Bumper and Rock Sliders for installation.

## Fender Flares

|               |  |           |          |
|---------------|--|-----------|----------|
| Fender Flares | Defender (except 6x6 & PRO), DefenderMAX | 715006821 | \$264.99 |
|               | Defender6x6                              | 715005409 | \$379.99 |
|               | DefenderPRO                              | 715006001 | \$319.99 |

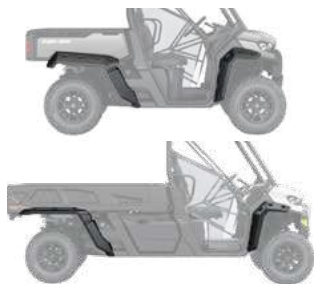

- Robust injection-molded polypropylene construction.
- Perfect for keeping mud and debris outside the vehicle.
- Include front and rear extension, and all mounting hardware.
- Ideal for track equipped vehicles.

## Sport Fender Flares

|  |           |          |
|--|-----------|----------|
| Defender (except 6x6 & PRO), DefenderMAX | 715003898 | \$259.99 |
|--|-----------|----------|



- Sleek fender flares just the right size to reduce mud and debris kick-up from your tires.
- Robust injection-molded polypropylene construction.
- Include front and rear extension, and all mounting hardware.

## Rock Sliders

|              |                          |                     |          |
|--------------|--------------------------|---------------------|----------|
| Rock Sliders | Defender                 | ■ 715006671 - Black | \$479.99 |
|              | DefenderMAX, DefenderPRO | ■ 715006721 - Black | \$709.99 |



- Heavy-duty rock sliders made of painted 1/2" (12.7 mm) aluminum with an integrated step for elevated cargo box access.
- Protect vehicle's sides and undercarriage against large obstacles.
- Lodge tight up against vehicle body for better clearance from obstacles.
- Not compatible with other rock sliders.
- Sold in pairs.
- Standard on DefenderX m r, DefenderMAX X m r and DefenderXT-P models.

## Rock Sliders

|                          |           |          |
|--------------------------|-----------|----------|
| Defender, Defender6x6    | 715002569 | \$379.99 |
| DefenderMAX, DefenderPRO | 715003040 | \$449.99 |



- Protect vehicle's sides and undercarriage against large obstacles.
- Made of heavy-duty 1.5" (3.8 cm) diameter steel tubing.
- Inside and outside anti-corrosion coating with durable powdercoat finish.
- Integrated step for easy cargo box access.
- Sold in pairs.

## Mud Flaps

|                       |           |          |
|-----------------------|-----------|----------|
| Defender, DefenderMAX | 715003041 | \$159.99 |
|-----------------------|-----------|----------|



- Keep mud and debris out of cargo area and protect trailer or vehicles behind you.
- Add aesthetic appeal to your vehicle.
- Made of EPDM rubber.
- Require RearBumper for installation.
- Sold in pairs.

# LinQ EASY ON, EASY OFF CARGO



## DEFENDERS LinQ ACCESSORIES

### Mounting location and requirements

|  |   |  |  |
|--|---|--|--|
| <ul style="list-style-type: none"> <li>•No tools needed: Quickly install and remove accessories by hand</li> <li>•Equip your Can-Am for specialized tasks in no time</li> <li>•Sturdy mounting system that holds up to the roughest terrain</li> </ul> | Cargo Bed<br>(long box bed LinQ)        | LinQ Cargo Rack<br>715006140   | Adventure Roof Rack<br>715003870 /715004391          |
| <b>LinQ Accessories with 16" Base</b>  |   | <ul style="list-style-type: none"> <li>•LinQ anchors mounted 16 inches apart, center-to-center.</li> <li>•Lower loading capacity than the LinQ with 36" base accessories.</li> <li>•Can be used on Can-Am ATV and SxS vehicles, Can-Am Spyder and RYK Sea-Doo watercraft and Ski-Doo snowmobiles.</li> </ul> |  |
| LinQ 4.2 Gal Cooler<br>295100698 White<br>219400964 Black  | LinQ Base Installation Kit<br>715008125 | LinQ Base Installation Kit<br>715008125  | No compatibility                                     |
| LinQ Tool Kit<br>715006829   |   | No further requirements  | No further requirements                              |
| LinQ Tool Box<br>715008111   |   |  |  |
| LinQ SR 5.5 Gal (21 L) Bag<br>860202449  |   |  |  |
| LinQ 4.5 Gal (17 L) Sport Bag<br>860202447   |   |  |  |
| LinQ Modular Box<br>715005494 (10 L)<br>715007112 (20 L)<br>715006830 (30 L)   |   |  |  |
| LinQ Roll-Top Bag<br>715008110   |   | No compatibility   |  |
| <b>LinQ Accessories with 36" Base</b>  |   | <ul style="list-style-type: none"> <li>•Mount on LinQ racks often used by Can-Am ORV vehicles.</li> <li>•Higher loading capacity than the LinQ with 16" base accessories.</li> <li>•Usage is limited to Can-Am ORV vehicles.</li> </ul>  |  |
| LinQ 12 Gal (45 L) Cargo Box<br>715003879  | No compatibility                        | No further requirements  | No further requirements                              |
| LinQ 23 Gal (86 L) Trunk Box<br>715004923  |   |  |  |
| LinQ 11.5 Gal (43 L) Audio Cargo Box<br>715003018  |   |  |  |
| LinQ 8 Gal (30 L) Cooler Box<br>715004778 Black<br>715004698 Gray  |   |  | No compatibility                                     |
| LinQ Premium Storage Bag by OGIO<br>715002923 Black  |   |  | No further requirements                              |
| LinQ Heavy Duty Basket<br>715001215  |   |  |  |
| LinQ Low Profile Basket<br>715004282   |   |  |  |
| <b>LinQ Holders</b>  |   |  |  |
| LinQ Gear Grips<br>715005340   | No further requirements                 | No further requirements  | Side wall installation<br>LinQ Adapters<br>715003058 |
| LinQ Tool Holder<br>715007358  |   |  |  |



## LinQ Accessories with 16" Base

|                  |                       |                    |          |
|------------------|-----------------------|--------------------|----------|
| LinQ Modular Box | Defender, DefenderMAX | 715005494 · (10 L) | \$139.99 |
|                  |                       | 715007112 · (20 L) | \$159.99 |
|                  |                       | 715006830 · (30 L) | \$179.99 |



- Allows stacking of other modular boxes to always have the right gear accessible.
- Always have the right box size to fit everything.
- Can be installed on any LinQ base with a 16" width.
- See table for installation location and requirements.

|  |                       |           |         |
|--|-----------------------|-----------|---------|
| Thermal Insert for LinQ Modular Box (10 L) | Defender, DefenderMAX | 219401110 | \$55.99 |
|--|-----------------------|-----------|---------|



- Insulated liner.
- Fits very well in the LinQ Modular Box (10 L).
- Can contain seven 355 mL cans.
- Keeps ice cold for one day.
- Interior dimensions: 9" L x 17" W x 2 1/8" H.

|               |                       |           |          |
|---------------|-----------------------|-----------|----------|
| LinQ Tool Box | Defender, DefenderMAX | 715008111 | \$174.99 |
|---------------|-----------------------|-----------|----------|



- High precision injected HDPE construction provides rigidity and durability.
- 5 gal (19 L) maximum capacity.
- Weather-resistant, sealed and lockable cover.
- Easy one-second on/off tool-less system.
- All the benefits of LinQ - simple, fast and secure.
- See table for installation location and requirements.

|               |                       |           |          |
|---------------|-----------------------|-----------|----------|
| LinQ Tool Kit | Defender, DefenderMAX | 715006829 | \$309.99 |
|---------------|-----------------------|-----------|----------|



- Includes:
  - Cutter pliers
  - Long-nose pliers
  - Locking pliers
  - Ratchet wrench 1/2" drive
  - 6" ratchet extension
  - Integrated CVT belt storage location (belt not included)
  - Long-socket 19 mm 1/2" drive - 6 pts
  - Socket 18 mm 1/2" drive
  - Long-socket 17 mm 1/2" drive - 6 pts
  - Socket 15 mm 1/2" drive
  - Socket 13 mm 1/2" drive
  - Socket 10 mm 1/2" drive
  - Socket 8 mm 1/2" drive
  - Combined wrench 19 mm 1/2" drive
  - Combined wrench 18 mm 1/2" drive
  - Combined wrench 15 mm 1/2" drive
  - Combined wrench 13 mm 1/2" drive
  - Combined wrench 10 mm 1/2" drive
  - Combined wrench 8 mm 1/2" drive
  - SocketTox! T40 1/2" drive
  - SocketTox! T30 1/2" drive
  - SocketTox! T20 1/2" drive
  - Breakerbar 1/2" drive
- See table for installation location and requirements.

|                            |                       |                     |          |
|----------------------------|-----------------------|---------------------|----------|
| LinQ 4.2 Gal (16 L) Cooler | Defender, DefenderMAX | ■ 219400964 · Black | \$369.99 |
|                            |                       | ■ 295100698 · White |          |



- All the benefits of LinQ - simple, fast and secure.
- Rotomolded construction for exceptional rigidity and durability.
- Premium-quality foam insulation for optimal ice retention.
- Uses LinQ mounting system (Patent US 8777531 and US 8875830).
- Easy one-second on/off tool-less system.
- Can contain twenty 355 mL cans.
- Keeps ice cold for three days.
- Exterior dimensions: 13" L x 20" W x 10" H.
- Interior dimensions: 9" L x 17" W x 7" H.
- See table for installation location and requirements.

|                            |                       |           |          |
|----------------------------|-----------------------|-----------|----------|
| LinQ SR 5.5 Gal (21 L) Bag | Defender, DefenderMAX | 860202449 | \$224.99 |
|----------------------------|-----------------------|-----------|----------|



- Semi-rigid expandable bag.
- 5.5 gal (21 L) capacity.
- See table for installation location and requirements.

|                               |                       |           |          |
|-------------------------------|-----------------------|-----------|----------|
| LinQ 4.5 Gal (17 L) Sport Bag | Defender, DefenderMAX | 860202447 | \$204.99 |
|-------------------------------|-----------------------|-----------|----------|



- 4.5 gal (17 L) capacity.
- Rigid bottom, semi-rigid top.
- See table for installation location and requirements.

|                          |                        |           |          |
|--------------------------|------------------------|-----------|----------|
| <b>LinQ Roll-Top Bag</b> | Defender, Defender MAX | 715008110 | \$229.99 |
|--------------------------|------------------------|-----------|----------|



- Fully waterproof roll-top dry bag will securely store and confine your equipment.
- LinQ mounted using heavy-duty rigid plastic base.
- High capacity storage solution (40 L).
- Bottom foam liner for additional equipment protection.
- Integrated handle for easy transportation on/off the vehicle.
- Dimensions: 14"L x 19"W x adjustable H.
- See table for installation location and requirements.

|                          |                        |           |          |
|--------------------------|------------------------|-----------|----------|
| <b>LinQ Explorer Bag</b> | Defender, Defender MAX | 295101016 | \$449.99 |
|--------------------------|------------------------|-----------|----------|



- 26 gal (100 L) of watertight storage.
- Installs in seconds with toolless LinQ accessory system.
- Dedicated essentials compartment for registration, license, insurance and more.
- Exclusive D E S S .key storage.
- External quick-access pocket for small items like keys and wallets.
- Turns into a backpack when you get off your machine.
- Collapsible if not fully packed with straps on both sides.
- Requires LinQ MultiCargo Rack for installation.
- Dimensions: 26"L x 18"W x 14"H.

## LinQ Accessories with 36" Base

|                                     |                        |           |          |
|-------------------------------------|------------------------|-----------|----------|
| <b>LinQ 12 Gal (45 L) Cargo Box</b> | Defender, Defender MAX | 715003879 | \$319.99 |
|-------------------------------------|------------------------|-----------|----------|



- Holds cargo safely and securely while riding.
- See table for installation location and requirements.

|                                     |                        |           |          |
|-------------------------------------|------------------------|-----------|----------|
| <b>LinQ 23 Gal (86 L) Trunk Box</b> | Defender, Defender MAX | 715004923 | \$369.99 |
|-------------------------------------|------------------------|-----------|----------|



- Lockable and weather-resistant.
- Holds cargo safely and securely while riding.
- See table for installation location and requirements.

|   |                        |           |          |
|---|------------------------|-----------|----------|
| <b>LinQ 11.5 Gal (43 L) Audio Cargo Box</b> | Defender, Defender MAX | 715003018 | \$759.99 |
|---|------------------------|-----------|----------|



- An affordable and quick solution for adding music and storage to your next ride.
- The rear installation does not use up any cab space and allows easy listening at an average speed.
- Mounts on/off easily to hold/carry cargo safely and securely.
- The Bluetooth enabled receiver and 6.5" (16.5 cm) speakers are smartly concealed and integrated in the cover.
- Automatic shut-off function protects your battery by turning the system off after 10 minutes of inactivity.
- Backlit control panel perfect for night riding.
- Water-resistant speakers.
- See table for installation location and requirements.

|                                     |                        |  |          |
|-------------------------------------|------------------------|--|----------|
| <b>LinQ 8 Gal (30 L) Cooler Box</b> | Defender, Defender MAX | <span style="color: gray;">■ 715004698 - Gray</span><br><span style="color: black;">■ 715004778 - Black</span> | \$439.99 |
|-------------------------------------|------------------------|--|----------|



- Installs without vehicle modification.
- Rotomolded construction provides exceptional rigidity and durability.
- Premium-quality foam insulation for optimal retention.
- Integrated, fully removable compartment protects food.
- Robust rubber latches keep the cover tightly closed.
- Weather-resistant.
- Convenient drain plug.
- See table for installation location and requirements.

|   |                        |                     |          |
|---|------------------------|---------------------|----------|
| <b>LinQ Premium Storage Bag by OGIO</b> | Defender, Defender MAX | ■ 715002923 - Black | \$439.99 |
|---|------------------------|---------------------|----------|



- 17.2 gal (65 L) capacity semi-rigid cargo bag ideal for carrying anything you need on your vehicle.
- Buckle and elastic closure with a rubber seal that protects dust from entering the bag.
- 3-section lid for partial or full access to your bag.
- Inside separators for optimal bag organization.
- See table for installation location and requirements.

|                               |                        |           |          |
|-------------------------------|------------------------|-----------|----------|
| <b>LinQ Heavy-Duty Basket</b> | Defender, Defender MAX | 715001215 | \$269.99 |
|-------------------------------|------------------------|-----------|----------|



- Made of high-strength, low-alloy steel.
- See table for installation location and requirements.

|                                |                        |           |          |
|--------------------------------|------------------------|-----------|----------|
| <b>LinQ Low Profile Basket</b> | Defender, Defender MAX | 715004282 | \$209.99 |
|--------------------------------|------------------------|-----------|----------|



- Low profile, open basket increases cargo space.
- Perfect for easy access to tools, rope, winch and power accessories.
- Multiple bungee cord and tie-down anchorpoints.
- Made of impact-resistant injection polypropylene.
- See table for installation location and requirements.

|                                |   |           |          |
|--------------------------------|---|-----------|----------|
| <b>LinQ Tailgate Extension</b> | Defender, Defender MAX<br>(except 6x6 and PRO models) | 715002464 | \$299.99 |
|                                | Defender 6x6 & PRO                                    | 715005412 | \$309.99 |



- Adds rear cargo capacity when the tailgate is open.
- Steel tubing-system style barrier mounts on top of the bed walls using the easy, tool-less LinQ system.
- Can be mounted to serve as cargo divider at different locations along the bed wall while preventing larger items from falling off the back.
- Stores neatly out of the way and offers additional cab area protection since it can be mounted upside down on the front bed wall as a mini-headache rack.
- Anti-corrosion coating with durable powdercoat finish.
- Not compatible with hard rear windows on Defender MAX produced before January 2021.

|                         |   |           |          |
|-------------------------|---|-----------|----------|
| <b>LinQ Tire Holder</b> | Defender (except 6x6 & PRO models),<br>Defender MAX | 715003448 | \$229.99 |
|-------------------------|---|-----------|----------|



- Cargo box spare-tire holder.
- Heavy-duty steel construction.
- Inside and outside anti-corrosion coating with durable powdercoat finish.
- Mounts on top of the bed walls using the easy, tool-less LinQ system.
- Compatible with Bed Wall Extender.
- Uses BRP standard wheel bolt pattern to mount tire (nuts included).
- Accommodates BRP tires up to 28" (wheel not included).
- Quickly allows installation in multiple positions thanks to the LinQ system.

|                        |                        |           |          |
|------------------------|------------------------|-----------|----------|
| <b>LinQ Cargo Rack</b> | Defender, Defender MAX | 715006140 | \$419.99 |
|------------------------|------------------------|-----------|----------|



- Strong, durable steel rack.
- Easy and tool-less installation thanks to the LinQ system.
- Allows the installation of LinQ accessories.
- 2 racks can be installed at the same time.
- Allows multi-level storage on cargo bed, accommodates 5 gal (19 L) bucket.
- Helps keep cargo securely in place.
- Multiple bungee cord and tie-down anchorpoints.
- Kit includes LinQ Base.
- Provides more usable space in the cargo box.
- Extends vehicle cargo options.

|                        |                        |           |          |
|------------------------|------------------------|-----------|----------|
| <b>LinQ Front Rack</b> | Defender, Defender MAX | 715006064 | \$499.99 |
|------------------------|------------------------|-----------|----------|



- Rugged locking front rack mounts on top of vehicle hood and provides additional storage.
- Heavy-duty 1.25" (32 mm) diameter steel tube construction.
- Inside and outside anti-corrosion coating with durable powdercoat finish.
- Flip-up configuration provides easy access to service area.
- Allows the installation of LinQ accessories (especially for use with LinQ Low Profile Basket (715004282)).
- Kit includes LinQ Base.
- Multiple bungee cord and tie-down anchorpoints.
- Requires RancherBumper (715005410) or FrontBumper (715002418 or 715005754) for installation.
- A great place to store tools while working in the field.
- Allows the installation of LinQ Low Profile Basket.



## LinQ Holders

### LinQ Tool Holder

Defender, Defender MAX

715007358

\$54.99



- Ultra-versatile toolholder.
- Convenient swivel latch allows tools to be stored in any orientation.
- Suitable for installation onto the cargo walls, Deluxe Headache Rack, Bed Wall Extender, Adventure Roof Rack and LinQ Loadout Rack.
- If mounted on the Deluxe Headache Rack or the Bed Wall Extender, LinQ Adapter is required for installation.
- Sold in pairs.

### LinQ Gear Grips

Defender, Defender MAX

715005340

\$144.99



- Durable and flexible grips provide a custom fit for a variety of items from 1" to 4" (2.5 cm to 10 cm) in diameter.
- Heavy-duty design for carrying bows, fishing poles, rakes, farm tools and more.
- Quick-release button opens grip quickly for easy access to gear.
- Heavy-duty base system built for the toughest adventures.
- Make transporting your tools a snap by combining the Gear Grips with the LinQ system.
- 360° orientation.
- Sold in pairs.

## LinQ Mounting

### LinQ Adapter

Defender, Defender MAX

715003058

\$34.99



- Allows the installation of the LinQ Tool Holder to the Bed Wall Extender, Adventure Roof Rack or the Deluxe Headache Rack.
- Sold in pack of 4.

### LinQ Lock

Defender, Defender MAX

860201968

\$61.99



- Simple way to securely lock most LinQ accessories.
- Lock cover protects lock from the elements.
- Corrosion resistant.
- Pack of 1, includes 2 keys.
- Not compatible with LinQ 4.2 US gal (16 L) Cooler, LinQ Toolbox, LinQ Tool Holder or LinQ Gear Grips.

### LinQ Base Installation Kit

Defender, Defender MAX

715008125

\$29.99



- Unique mounting fastener usable on any LinQ system accessory.
- Included: 2 LinQ Cargo Bases and hardware.

### LinQ Replacement Part

Defender, Defender MAX

715001707

\$27.99



- Unique mounting fastener usable on any LinQ system accessory.
- Toolless installation and removal.
- Sold in pairs.



|                     |                        |           |            |
|---------------------|------------------------|-----------|------------|
| <b>Loadout Rack</b> | Defender, Defender MAX | 715005447 | \$1,419.99 |
|---------------------|------------------------|-----------|------------|



- LinQ installed versatile rack that creates a second level of storage.
- Adjustable height that goes from mid cab height to roofline.
- Modular basket adapts to different cargo with folding front and rear panels.
- Multiple hooks and holes to hang items both inside and outside the rack.
- Basket accommodates multiple LinQ positions.
- Combine with cargo net to create a hanging storage net below the basket for additional space.
- 2 racks can be installed on Defender PRO & Defender 6x6.

|                                |                        |           |          |
|--------------------------------|------------------------|-----------|----------|
| <b>Hanging Storage Box Kit</b> | Defender, Defender MAX | 715005449 | \$164.99 |
|--------------------------------|------------------------|-----------|----------|



- Versatile rack designed to hold a standard storage box.
- Fully adjustable, the rack can be tailored to hold the crates in multiple positions: headache rack position, inside the box along the side wall, and outside the box along the side wall.
- Includes Can-Am branded storage box.
- Exterior Cargo Reinforcement Panels recommended when used outside of bed wall.

|   |                        |           |         |
|---|------------------------|-----------|---------|
| <b>Can-Am Storage Box</b><br><i>(Not illustrated)</i> | Defender, Defender MAX | 708303237 | \$14.99 |
|---|------------------------|-----------|---------|

- Conventional 13" x 13" plastic storage box with Can-Am branding.
- Perforated bottom allows water and debris to escape.

|   |  |           |         |
|---|--|-----------|---------|
| <b>Exterior Cargo Reinforcement Panel</b><br><i>(Not illustrated)</i> |  | 715006198 | \$60.99 |
|---|--|-----------|---------|

- Plate that attaches to the bed side to further support and protect bed wall when in outward position.
- Recommended use of the hanging storage box and/or gun and tool holder when installed outside of the bed wall (except Defender 6x6 & PRO).

|                             |                        |           |          |
|-----------------------------|------------------------|-----------|----------|
| <b>Deluxe Headache Rack</b> | Defender, Defender MAX | 715002423 | \$459.99 |
|-----------------------------|------------------------|-----------|----------|



- Protects cab components from cargo load.
- Increases box capacity when used in tandem with the Bed Wall Extender (715002421).
- Required to install the Bed Wall Extender (715002421).
- Compatible with gear rail.

|                      |                        |           |          |
|----------------------|------------------------|-----------|----------|
| <b>Headache Rack</b> | Defender, Defender MAX | 715003873 | \$294.99 |
|----------------------|------------------------|-----------|----------|



- Full rear roll cage coverage offers a heavy-duty steel protective line of defense between your head or cab's components and the load in your cargo bed.
- Compatible with gear rail.
- Rack's open design helps maintain a clear rear view.
- Not compatible with Bed Wall Extender and Audio Roofs.

|                          |   |           |            |
|--------------------------|---|-----------|------------|
| <b>Bed Wall Extender</b> | Defender,<br>Defender MAX<br>(except Defender 6x6 & Defender PRO) | 715002421 | \$999.99   |
|                          | Defender 6x6 & PRO models   | 715005411 | \$1,699.99 |



- Increases box capacity.
- Quick and easy tool-less modularity.
- Easily removable rear door can be latched open.
- Variable full or half height settings.
- Foldable top panels come off in seconds.
- Requires Deluxe Headache Rack (715002423).

|                      |   |           |          |
|----------------------|---|-----------|----------|
| <b>Tonneau Cover</b> | Defender 2018 & up (except Mossy Oak Break-Up Country Camo models), Defender M AX (except 6x6 and PRO models) | 715008306 | \$284.99 |
|----------------------|---|-----------|----------|



- Fitted to cover all of the items in your cargo box thoroughly.
- Prevents splash from entering the cargo box.
- Rolls up to the front.
- Easily removable for quick access.
- Not compatible with accessories that exceed the box height.

|                              |                         |           |         |
|------------------------------|-------------------------|-----------|---------|
| <b>Removable Storage Bin</b> | Defender, Defender M AX | 715004344 | \$83.99 |
|------------------------------|-------------------------|-----------|---------|



- Handy, removable on-dash toolbox will make sure you have your critical equipment where you need it.
- Provides 1.7 gal (6.3 L) of storage and clips on and off in a snap.
- Water-resistant to ensure your contents remain safe and dry.
- Standard on all models except Base.

|  |                         |           |         |
|--|-------------------------|-----------|---------|
| <b>Removable Storage Bin – Passenger</b> | Defender, Defender M AX | 715003314 | \$99.99 |
|--|-------------------------|-----------|---------|



- Convenient passenger-side underseat storage.
- Polypropylene-injected 3.7 gal (14 L) storage capacity bin.
- Bin installs and removes in a snap and comes with an integrated handle.
- Water-resistant.

|                                     |                         |           |          |
|-------------------------------------|-------------------------|-----------|----------|
| <b>Driver Underseat Storage Bin</b> | Defender, Defender M AX | 715003399 | \$129.99 |
|-------------------------------------|-------------------------|-----------|----------|



- Polypropylene-injected 4 gal (15 L) capacity bin fits securely under the driver's seat.
- Front opening for quick and easy access.
- Ideal for storing weather-resistant items, such as ropes, tow straps and winch accessories that are needed at a moment's notice.

|                                     |                         |           |         |
|-------------------------------------|-------------------------|-----------|---------|
| <b>Center Underseat Storage Bin</b> | Defender, Defender M AX | 715003446 | \$99.99 |
|-------------------------------------|-------------------------|-----------|---------|



- Polypropylene-injected 2 gal (8 L) capacity storage bin.
- Water-tight design keeps ice and drinks cold.
- Easy to drain and wash by removing it with integrated handle.
- Accessible by lifting center seat section.

|                        |  |           |          |
|------------------------|--|-----------|----------|
| <b>Cargo Bed Rails</b> | Defender (except 6x6 & PRO), Defender M AX | 715003444 | \$139.99 |
|------------------------|--|-----------|----------|



- Add integrated tie-down area to your cargo box while enhancing the look.
- Added cargo box protection.
- Inside and outside anti-corrosion coating with durable powdercoat finish.
- Heavy-duty 1" (2.5 cm) diameter steel tube construction.
- Add height to the bed side wall and serve as a tie-down anchor for ropes, straps or bungees.
- Not compatible with Bed Wall Extender and Headache Rack (715003873).
- Sold in pairs.

|                      |  |           |         |
|----------------------|--|-----------|---------|
| <b>Cargo Bed Net</b> | Defender (except 6x6 & PRO), Defender M AX | 715003445 | \$83.99 |
|----------------------|--|-----------|---------|



- Solid net designed to hook to the bottom of the cargo box for secure and compact confinement of your cargo.
- Keeps items tightly against the bed floor.

|  |  |           |         |
|--|--|-----------|---------|
| <b>Dash Storage Compartment Net for Heating System</b> | Defender, Defender M AX (2019 & prior) | 715003544 | \$32.99 |
|--|--|-----------|---------|



- Perfect for securing items in the dash storage area.
- To be installed when Lower Dashboard for Heating System is installed.



|   |                                       |           |         |
|---|---------------------------------------|-----------|---------|
| <b>Lower Dashboard for Heating System</b> | Defender, Defender MAX (2019 & prior) | 715003441 | \$85.99 |
|---|---------------------------------------|-----------|---------|



- Replaces the dashboard that comes stock with the vehicle, and features a tablet that makes it possible for driver and passenger to conveniently store small items in the dash.
- To be installed when the Defrost, Heat & Ventilation System is installed.
- Use together with the Dash Storage Compartment Net for Heating System (715003544) to prevent the items placed in the dash storage compartment from falling.

|                                      |  |           |         |
|--------------------------------------|--|-----------|---------|
| <b>Dash Storage Compartment Nets</b> | Defender, Defender MAX (except Lin Edition models) | 715003129 | \$34.99 |
|--------------------------------------|--|-----------|---------|



- Perfect for securing items in the dash storage area.
- Not compatible with Defrost, Heat & Ventilation System.
- Sold in pairs.

|                     |                        |           |          |
|---------------------|------------------------|-----------|----------|
| <b>Bed Tool Box</b> | Defender, Defender MAX | 715003028 | \$419.99 |
|---------------------|------------------------|-----------|----------|



- Large 40 gal (150 L) multifunction weather-resistant toolbox designed for cargo beds.
- Rotomolded construction provides exceptional rigidity and durability.
- Features cup holders and integrated groove for pipe or 2x4 cutting.
- Sized to give you the option of installing 2 toolboxes in the cargo bed (quick bolt-on installation).
- Double side openings with lockable covers and rubber latches.

|                         |                        |           |          |
|-------------------------|------------------------|-----------|----------|
| <b>Soft Storage Bag</b> | Defender, Defender MAX | 715003759 | \$179.99 |
|-------------------------|------------------------|-----------|----------|



- 11.8 gal (45 L) capacity soft cargo bag designed with vehicle's rear in mind to maximize potential storage.
- 3 sections.
- Weatherproof.

|                              |              |           |         |
|------------------------------|--------------|-----------|---------|
| <b>Backrest Rear Storage</b> | Defender MAX | 715003019 | \$59.99 |
|------------------------------|--------------|-----------|---------|



- Netting installs easily.
- Made from polyester that won't discolor.
- Sold in pairs.

|                                   |                        |           |          |
|-----------------------------------|------------------------|-----------|----------|
| <b>Storage 2.6 Gal (10 L) Bag</b> | Defender, Defender MAX | 269502121 | \$149.99 |
|-----------------------------------|------------------------|-----------|----------|



- Roll-top dry bag for fully protecting your cargo from the elements.

|                                       |                        |           |          |
|---------------------------------------|------------------------|-----------|----------|
| <b>NEW Passenger Storage Seat Bag</b> | Defender, Defender MAX | 715008080 | \$249.99 |
|---------------------------------------|------------------------|-----------|----------|



- This weather-resistant bag holds your gear safely and securely while you ride.
- Bag settling on the passenger seat to increase the vehicle's cargo capacity.
- This bag features a 14.5 gal (55 L) storage capacity and is divided into two compartments.
- The top compartment is insulated to keep your beverages cold and includes two cup holders.
- Additional pocket inside for additional storage, such as a cellphone.
- The bottom compartment is accessible from both sides and serves as a large pocket for storing various items.
- The detachable pocket at the front of the bag can be used as a garbage bag.

# RACKS & HOLDERS



|                           |                         |           |          |
|---------------------------|-------------------------|-----------|----------|
| <b>Rear Accessory Bar</b> | Defender, Defender M AX | 715005450 | \$124.99 |
|---------------------------|-------------------------|-----------|----------|



- Strong accessory bar allowing installation or hanging items off the back.
- Holes for carabiners, duck decoy hangers or other items.
- LinQ anchors allow installation of many LinQ accessories.

|                            |  |           |          |
|----------------------------|--|-----------|----------|
| <b>Adventure Roof Rack</b> | Defender<br>Loads of up to 40 lb (18 kg).      | 715003870 | \$659.99 |
|                            | Defender M AX<br>Loads of up to 75 lb (34 kg). | 715004391 | \$799.99 |



- Ideal cargo solution for packing everything you need to live your off-road experience fully and completely.
- Built with heavy-duty 1.25" (3.2 cm) diameter steel tubing.
- Modular LinQ support plates allow for installation of most LinQ cargo accessories.
- Integrated mounting points for lights can hold up to 8 pod-type LED lights (6 front and 2 back) or a 39" (99 cm) LED bar (front) - see table for compatibility.
- Features anchor points for spare tire attachment.
- Spare Tire Tie-Downs sold separately.
- Add the Cargo Box Net or the Cargo Box Elastic Net to secure and confine your cargo in the rack.
- Not compatible with Binini Roof for Audio Roof.

|                                     |                         |           |         |
|-------------------------------------|-------------------------|-----------|---------|
| <b>Spare Tire Ratchet Tie-Downs</b> | Defender, Defender M AX | 280000955 | \$32.99 |
|-------------------------------------|-------------------------|-----------|---------|



- 3-way ratcheting tie-down strap with loop ends.
- Designed to securely hold spare tires on accessories equipped with integrated spare tire attachment points.
- Adjustable to accommodate most common UTV tire sizes.
- Ratchet and junction ring made of durable zinc-plated steel.
- Required for spare tire attachment on Adventure Roof Rack.

|                                   |                         |           |          |
|-----------------------------------|-------------------------|-----------|----------|
| <b>LinQ Tool &amp; Gun Holder</b> | Defender, Defender M AX | 715005466 | \$529.99 |
|-----------------------------------|-------------------------|-----------|----------|



- 2-in-1 holding rack can be used both on the job or on the hunt.
- Includes 5 locations to securely hold tools and guns using rubber grips and retention straps at the top and a nubbin at the bottom with gunstock shaped molding at the bottom.
- Easy to remove, install or reposition using our simple and secure LinQ system.
- Can be attached at multiple positions along the cargo bed walls, facing inside or outside the bed.
- Recommended to use with the Exterior Cargo Reinforcement Panel (715006198) when installed outside the bed wall.

|                      |                         |           |          |
|----------------------|-------------------------|-----------|----------|
| <b>LinQ Gun Case</b> | Defender, Defender M AX | 715004968 | \$269.99 |
|----------------------|-------------------------|-----------|----------|



- Practical design allows you to store shotguns and rifles up to 52" (1.32 cm) even with most optic configurations.
- Adapts to different weapon shapes and features with foam cushions that can be repositioned.
- LinQ mounted for efficient and secure storage, locked in place with only a quarter turn.
- LinQ Gun Case Mounting Kit (715006443) is required for installation.

|                                   |                         |           |         |
|-----------------------------------|-------------------------|-----------|---------|
| <b>LinQ Gun Case Mounting Kit</b> | Defender, Defender M AX | 715006443 | \$69.99 |
|-----------------------------------|-------------------------|-----------|---------|



- Required to install the LinQ Gun Case on a Defender and Defender M AX.
- Allows you to install up to two LinQ gun cases.
- Includes one pair.

|   |                       |           |          |
|---|-----------------------|-----------|----------|
| <b>Gun Boot 6.0+ Impact by Kolpin<sup>†</sup></b> | Defender, DefenderMAX | 715001419 | \$109.99 |
|---|-----------------------|-----------|----------|



- Extra room for pistol-grip-type weapons and small bipods.
- Easily fits firearms up to 51" (1.3 m) in total length.
- Provides ample room for 2.4" (60 mm) scopes.
- Hatchback design allows easy access.
- Snap-close cover with locking capability.
- Ergonomically designed handle and molded attachment points for sling.
- Designed to accommodate left- and right-hand bolt-action rifles and shotguns.
- Requires GearRail and Gun Boot Mount by Kolpin for installation.
- Includes removable, shock-absorbing foam and nylon impact liner for superior interior protection.
- Compatible for dual mount with additional Gun Boot Mount.

|   |                       |           |          |
|---|-----------------------|-----------|----------|
| <b>Stronghold Gun Boot Impact<sup>†</sup> by Kolpin<sup>†</sup></b> | Defender, DefenderMAX | 705011442 | \$659.99 |
|---|-----------------------|-----------|----------|



- Compact low-profile design with Kolpin Stronghold styling securely holds up to 52" (1.32 cm) long rifles and shotguns with optics.
- Includes a removable, shock-absorbing foam impact liner.
- Single-handed opening with an attached lid for quick access along with an integrated closure strap.
- For use with the Kolpin Stronghold Auto Latch Mount System.

|  |   |           |         |
|--|---|-----------|---------|
| <b>Stronghold Auto-Latch Mount by Kolpin</b> | Defender, DefenderMAX (except X m models) | 715003899 | \$88.99 |
|--|---|-----------|---------|



- Auto-latching design provides quick and secure gun boot attachment to your vehicle.
- Bracket is made from rugged high impact, reinforced nylon and coated steel.
- For use with Stronghold Gun Boot.
- Requires GearRail for Stronghold (715004089).

|                                 |                       |           |          |
|---------------------------------|-----------------------|-----------|----------|
| <b>Gear Rail for Stronghold</b> | Defender, DefenderMAX | 715004089 | \$189.99 |
|---------------------------------|-----------------------|-----------|----------|



- Designed for the Stronghold Auto-Latch Mount by Kolpin.
- Can hold up to two Stronghold Gun Boots (two Latch Mounts required).
- Deluxe Headache Rack (715002423) or GearRail Adapter (715003392) required.

|                                 |                       |           |         |
|---------------------------------|-----------------------|-----------|---------|
| <b>Gun Boot Mount by Kolpin</b> | Defender, DefenderMAX | 715001420 | \$99.99 |
|---------------------------------|-----------------------|-----------|---------|



- Fits one Kolpin Gun Boot 6.0 Impact.
- Lightweight and extremely durable.
- Easily adjustable without the use of any tools.
- Offers precision gun angle adjustability.
- Requires GearRail for installation.

|                        |                       |           |          |
|------------------------|-----------------------|-----------|----------|
| <b>Dual Gun Holder</b> | Defender, DefenderMAX | 715005265 | \$229.99 |
|------------------------|-----------------------|-----------|----------|



- Accommodates shotguns, rifles or muzzleloaders.
- Mounts in the cab, on floorboard between driver and passenger.
- Rubber pads provide gun protection.
- Can be removed to allow a center passenger.
- Anti-corrosion coating with durable powder coat finish.
- Comes with all hardware for easy installation.
- Keeps your weapons within easy reach and protected within the cab area.
- Refer to your local regulations governing the transportation of firearms before purchase.

|                  |   |           |          |
|------------------|---|-----------|----------|
| <b>Gear Rail</b> | Defender, DefenderMAX (except X m models) | 715003391 | \$329.99 |
|------------------|---|-----------|----------|



- Stationary rail system specially designed for your side-by-side vehicle.
- Universal mounting options for any Kolpin accessories like Gear Grips and Universal Saw Press.
- Rail is made with heavy-duty 7-gauge extruded anodized black aluminum.
- Mounts on rollbar.
- Includes one versatile GearRail Mount by Kolpin.
- Requires Deluxe Headache Rack (715002423), Headache Rack (715003873) or GearRail Adapter (715003392).



## Gear Rail Adapter

Defender, Defender M AX  
(except X m rm o d e l s)

715003392

\$189.99



- Allows the installation of gear rails directly onto the cargo box without the need for a headache rack.

## Gear Rail Mount by Kolpin

Defender, Defender M AX

715001422

\$50.99



- Accessory bracket for mounting additional accessories to the Gear Rail.
- Includes C-clamp and metal mounting brackets.

## Double Gun Bag

Defender (except XT Cab, X m rm o d e l s),  
Defender M AX (except XT Cab and Limited  
package)

■ 715003133 -Black

\$179.99



- Shell constructed with heavy-duty, weather-resistant polyester to shelter guns from dust and other outdoor elements, while the thick interior padding protects the guns from shocks.
- Fits perfectly on rear cage, and guns are readily accessible from both sides of vehicle.
- Design features include a removable center pocket that can be mounted on both sides of the bag, and extra front storage pockets for hunting gear.
- Solid, quick installation.
- Not compatible with rear wind protection, headache racks and gear rails.
- May interfere with the tilt function of the Defender 6x6 or Defender PRO models' bed.

## Universal Saw Press by Kolpin

Defender, Defender M AX  
(except X m rm o d e l s)

715001423

\$144.99



- Specially crafted for transporting your chainsaw securely and safely aboard your side-by-side vehicle.
- Heavy-duty, black powder-coated metal bracket designed to attach any chainsaw model with up to a 20" (51 cm) bar.
- Rubber pads provide cushion and tight fit.
- Hinged design for quick removal.
- Holds saw in vertical position or 45° angle in either direction.
- Requires Gear Rail.
- Protective sheath included.

## LinQ Gear Grips

Defender, Defender M AX

715001421

\$87.99



- Durable, flexible grips cushion and protect while providing a custom fit for a variety of items from 1" to 4" (2.5 cm to 10 cm) in diameter.
- Heavy-duty design for carrying bows, fishing poles, rakes, farm tools and more.
- Quick-release button opens grip quickly for easy access to gear.
- Heavy-duty base system built for the toughest adventures.
- Easy installation on tubular racks, extension racks, brackets or bumpers.
- Sold in pairs.



| 1 Choose your mount point   |  | 2 Find your platform   |   | 3 Choose your lights  |  |  |
|---|--|--|---|---|--|--|
|   |  | 10(25 cm)<br>Double Stacked<br>LED Bar   | 15(38 cm)<br>Double Stacked<br>LED Bar  | 39(99 cm)<br>Double Stacked<br>LED Bar  | 4(10 cm)<br>Round LED LIGHTS<br>(Sold in pairs)  | 3.5(9 cm)<br>LED Lights<br>(Sold in pairs) |
| <b>Front Bumper</b><br><b>Rancher Bumper</b><br><b>XT Front Bumper</b><br><b>XT Front Bumper</b><br><small>(w/ or w/ in ch)</small><br><b>XT Front Bumper</b> | <i>Defender</i><br><i>Defender MAX 2019 &amp; prior</i>              | <b>715002933</b><br><small>PL</small><br><b>715002454</b><br><small>(Light Power Cable)</small>  | <b>715002934</b><br><small>PL</small><br><b>715002454</b><br><small>(Light Power Cable)</small>   | N/A   | <b>715002935</b> (4 Round),<br><b>715003665</b> (3.5 Flood)<br>or<br><b>715003666</b> (3.5 Spot)<br><small>PL</small><br><b>715002454</b> (Light Power Cable)  |  |
|   | <i>Defender</i><br><i>Defender MAX 2020 &amp; up</i>                 | <b>715002933</b><br><small>PL</small><br><b>715006034</b><br><small>(Light Power Cable)</small>  | <b>715002934</b><br><small>PL</small><br><b>715006034</b><br><small>(Light Power Cable)</small>   | N/A   | <b>715002935</b> (4 Round),<br><b>715003665</b> (3.5 Flood)<br>or<br><b>715003666</b> (3.5 Spot)<br><small>PL</small><br><b>715006034</b> (Light Power Cable)  |  |
| <b>Light Rack</b><br>or Light Bars<br><small>*Roof Power Cable and Front Roof Liner may not be required if already installed with other accessories.</small>  | <i>Defender &amp; Defender MAX</i><br><i>(except XT Cab)</i>         | <b>715002933</b><br><small>PL</small><br><b>715003094</b><br><small>(Roof Power Cable)</small><br>&<br><b>715008226</b><br><small>(Front Roof Liner)</small> | <b>715002934</b><br><small>PL</small><br><b>715003094</b><br><small>(Roof Power Cable)</small><br>&<br><b>715008226</b><br><small>(Front Roof Liner)</small>  | <b>715006226</b><br><small>(Light Bar Support)</small><br><small>PL</small><br><b>715004007</b><br><small>(39 Light Bar)</small><br><small>PL</small><br><b>715005822</b><br><small>(Power Cable)</small><br>&<br><b>715008226</b><br><small>(Front Roof Liner)</small> | <b>715002935</b> (4 Round),<br><b>715003665</b> (3.5 Flood)<br>or<br><b>715003666</b> (3.5 Spot)<br><small>PL</small><br><b>715003094</b> (Roof Power Cable)<br>&<br><b>715008226</b> (Front Roof Liner)   |  |
|   | <i>Defender</i><br><i>Defender MAX</i><br><i>XT Cab Limited</i>      | <b>715002933</b>   | <b>715002934</b>  | <b>715006226</b><br><small>(Light Bar Support)</small><br><small>PL</small><br><b>715004007</b><br><small>(39 Light Bar)</small><br><small>PL</small><br><b>715005822</b><br><small>(Power Cable)</small>   | <b>715002935</b> (4 Round),<br><b>715003665</b> (3.5 Flood)<br>or<br><b>715003666</b> (3.5 Spot)   |  |
| <b>Adventure Roof Rack</b><br><small>*Roof Power Cable may not be required if already installed with other accessories.</small>                               | <i>Defender &amp; Defender MAX</i><br><i>(except XT Cab Limited)</i> | N/A  | Front only<br><b>715002934</b><br><small>PL</small><br><b>715003417</b><br><small>(Power Cable)</small><br>&<br><b>715003094</b><br><small>(Roof Power Cable)</small><br>&<br><b>715008226</b><br><small>(Front Roof Liner)</small> | Front only<br><b>715004007</b><br><small>PL</small><br><b>715005822</b><br><small>(Power Cable)</small><br>&<br><b>715003094</b><br><small>(Roof Power Cable)</small><br>&<br><b>715008226</b><br><small>(Front Roof Liner)</small>                                     | Front or Rear<br><b>715002935</b> (4 Round),<br><b>715003665</b> (3.5 Flood)<br>or<br><b>715003666</b> (3.5 Spot)<br><small>PL</small><br><b>715003417</b> (Power Cable)<br>&<br><b>715003094</b> (Roof Power Cable)<br>&<br><b>715008226</b> (Front Roof Liner) |  |
|   | <i>Defender, Defender MAX XT Cab Limited</i>                         | N/A  | Front only<br><b>715002934</b><br><small>PL</small><br><b>715003417</b><br><small>(Power Cable)</small>   | Front only<br><b>715004007</b><br><small>PL</small><br><b>715005822</b><br><small>(Power Cable)</small>   | Front or Rear<br><b>715002935</b> (4 Round),<br><b>715003665</b> (3.5 Flood)<br>or<br><b>715003666</b> (3.5 Spot)<br><small>PL</small><br><b>715003417</b> (Power Cable)   |  |

**4 Order** **Order all part numbers in intersecting box**

\*Note: When installing more than one light kit, additional light power cable or mounting kit is required.

|   |                        |                  |                |
|---|------------------------|------------------|----------------|
| <b>Roof Power Cable</b><br><small>(Not illustrated)</small> | Defender, Defender MAX | <b>715003094</b> | <b>\$59.99</b> |
|---|------------------------|------------------|----------------|

- Required for installation of some electrical accessories.
- Brings power from the battery.

|  |                                       |                  |                |
|--|---------------------------------------|------------------|----------------|
| <b>Light Kit Power Cable</b><br><small>(Not illustrated)</small> | Defender, Defender MAX (2019 & prior) | <b>715002454</b> | <b>\$52.99</b> |
|  | Defender, Defender MAX (2020 & up)    | <b>715006034</b> | <b>\$49.99</b> |

- Power cable for installation of compatible CAN-AM light kits at front bumper location.

### 10" (25 cm) Double Stacked LED Light Bar (60 W)

Defender, Defender MAX

715002933

\$369.99



5,400 lumens

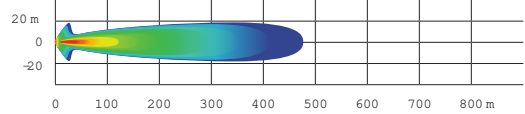

- Equipped with twelve 5 W Cree LEDs.
- 5,400 lumens.
- Packs a big punch for its size.
- Rugged and waterproof.
- Can be installed on front bumpers, sport roof and bin mirror of with sun visor.

- Requires light power cable for installation.
- Lights up to more than 1,500 ft (460 m) in front of the vehicle and around 65 ft (20 m) wide on each side.
- EC compliant.
- See table for installation location and requirements.

### 15" (38 cm) Double Stacked LED Light Bar (90 W)

Defender, Defender MAX

715002934

\$449.99



8,400 lumens

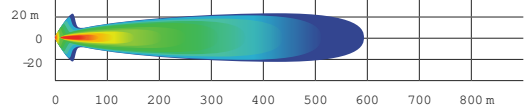

- Equipped with 18 5 W Cree LEDs.
- 8,400 lumens.
- Complements the LightRacks and most bumpers.
- Rugged and waterproof.

- Lights up to more than 1,900 ft (580 m) in front of the vehicle and around 65 ft (20 m) wide on each side.
- EC compliant.
- See table for installation location and requirements.

### 39" (99 cm) Double Stacked LED Light Bar (270 W)

Defender, Defender MAX

715004007

\$879.99



24,300 lumens

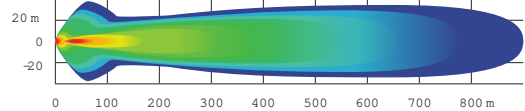

- Equipped with 54 5 W Cree LEDs.
- 24,300 lumens.
- Lights up to more than 2,900 ft (900 m) in front of the vehicle and around 115 ft (35 m) wide on each side.

- Compatible on the Adventure Roof Rack.
- Compatible with Flip Windshields and Full Windshields.
- See table for installation location and requirements.

### 4" (10 cm) Round LED Lights (2 x 25 W)

Defender, Defender MAX

715002935

\$449.99



1,800 lumens

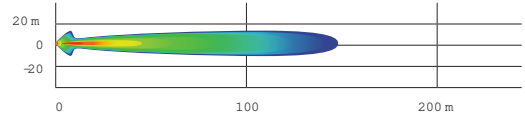

- 25 W LED spotlights.
- 1,800 lumens.
- Rugged and waterproof.
- Includes basic wiring and switch.
- Can-Am branded grill.

- Requires light power cable.
- Sold in pairs.
- Not EC compliant.
- See table for installation location and requirements.

### 3.5" (9 cm) LED Driving Lights (2 x 14 W)

Defender, Defender MAX

715003666

\$254.99



1,260 lumens

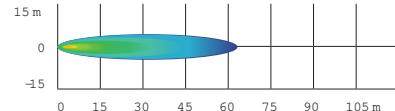

- 14 W LED lights producing 1,260 lumens each.
- Spot lens for a narrow and long light beam spread, ideal when driving at higher speeds.
- Equipped with six high-power LEDs in a heavy-duty die-cast aluminum housing.

- Features two attachment points. If one attachment point fails due to a collision, rotate to the next channel point and remount the light.
- Sold in pairs.
- EC compliant.
- See table for installation location and requirements.



|  |                        |           |          |
|--|------------------------|-----------|----------|
| <b>3.5" (9 cm) LED Flood Lights (2 x 14 W)</b> | Defender, Defender MAX | 715003665 | \$254.99 |
|--|------------------------|-----------|----------|

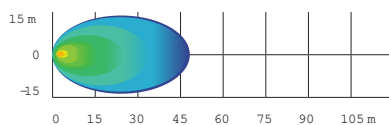

- 14 W LED lights producing 1,260 lumens each.
- Flood lens for a wide light beam spread, ideal for working applications like plowing or cornering. Suitable for dusty or foggy riding conditions.
- Equipped with six high-power LEDs in a heavy-duty die-cast aluminum housing.
- Features two attachment points. If one attachment point fails due to a collision, rotate to the next channel point and remove the light.
- Sold in pairs.
- EC compliant.
- See table for installation location and requirements.

|                          |                        |           |          |
|--------------------------|------------------------|-----------|----------|
| <b>Light Bar Support</b> | Defender, Defender MAX | 715006226 | \$139.99 |
|--------------------------|------------------------|-----------|----------|



- Mounting Bracket that allows the installation of the Can-Am 39" Lightbar (715004007).
- Low and forward mounting position for a sleek look.
- Compatible with all windshields, roofs and doors.

|                   |                        |           |          |
|-------------------|------------------------|-----------|----------|
| <b>Light Rack</b> | Defender, Defender MAX | 715002456 | \$194.99 |
|-------------------|------------------------|-----------|----------|



- Rugged steel construction serves as both mount and protection for accessory light systems.
- Lights not included.
- Front Roof Liner is required for installation on the roof (except Cab models or with Deluxe Sport Roof).
- Power Cable, Sport Roof, Deluxe Sport Roof or Sport Roof for MAX required for installation.
- Integrates elegantly and seamlessly into our roof products.

|                         |                                    |           |          |
|-------------------------|------------------------------------|-----------|----------|
| <b>Rear Cargo Light</b> | Defender, Defender MAX (2020 & up) | 715007077 | \$184.99 |
|-------------------------|------------------------------------|-----------|----------|



- Powerful 155W H3 illumination for rear cargo area.
- Convenient in-dash switch.
- Wiring included.
- Sport Roof (715002430) or Sport Roof for MAX (715003038) is required for installation.
- Not EC compliant.
- Not compatible with headache rack on Defender Pro and Defender 6x6.

|                                      |                                       |           |         |
|--------------------------------------|---------------------------------------|-----------|---------|
| <b>RAM<sup>®</sup> LED Spotlight</b> | Defender, Defender MAX (2019 & prior) | 710005423 | \$18.49 |
|--------------------------------------|---------------------------------------|-----------|---------|



- 540 lumens (9 watt) heavy-duty LED spotlight standard-equipped with 1" (2.5 cm) diameter rubber-coated double ballast socket system.

|                   |                        |           |         |
|-------------------|------------------------|-----------|---------|
| <b>Dome Light</b> | Defender, Defender MAX | 715002455 | \$84.99 |
|-------------------|------------------------|-----------|---------|



- LED array integrates perfectly with vehicle.
- Wiring included.
- Can be installed on cage or roof with or without roof liner.
- Not compatible with Defender Audio Roofs.

|                             |                                    |           |          |
|-----------------------------|------------------------------------|-----------|----------|
| <b>LED Signature Lights</b> | Defender, Defender MAX (2020 & up) | 715006896 | \$254.99 |
|-----------------------------|------------------------------------|-----------|----------|



- The stylish LED set puts the finishing touch to your Defender, accentuating its aggressive stance.
- Included on Limited and Lone Star models.

# AUDIO & COMMUNICATION SYSTEMS



|                          |          |           |                   |
|--------------------------|----------|-----------|-------------------|
| <b>Can-Am Audio Roof</b> | Defender | 715005206 | <b>\$3,499.99</b> |
|--------------------------|----------|-----------|-------------------|



- Full roof with sleek built-in audio.
  - Fully sealed and waterproof.
  - Easy to install: one wire connects the roof to the vehicle's electronics.
  - Four 8" speakers, one 280 watt amp, and one weatherproof source unit supplied by JL Audio®.
  - Speakers include LED lighting integrated into the grille, designed to uniformly illuminate with an RGB glow.
  - A 3" full color LCD display, with separate day/night lighting themes for visibility, even in bright sunshine.
  - AM /FM tuner.
- To install the Audio Roof with the following accessories, the Power Harnesses 715003094 & 715008781 are required:
  - Flip Glass Windshield Wiper & Washer Kit (715002441), Windshield Wiper & Washer Kit (715001638), Front Full Doors with Power Windows (715006331), Front Deluxe Full Doors (715005214), Rear Deluxe Full Doors (715005215).
  - Not compatible with Adventure Roof Rack and Headache Rack.
  - Not compatible with 39 in. (99 cm) Double Stacked LED Light Bar (270 W) (715004007) & Light Bar Support (715006226).

|                              |              |           |                   |
|------------------------------|--------------|-----------|-------------------|
| <b>Can-Am Audio Roof MAX</b> | Defender MAX | 715006879 | <b>\$4,599.99</b> |
|------------------------------|--------------|-----------|-------------------|



- Full roof with premium JL Audio system for Defender MAX.
  - Fully sealed and waterproof components and construction.
  - Simple to install: one connector connects the roof to the vehicle's electrical system.
  - Weatherproof components: Six 7.7" coaxial speakers, 280 watt amp, and 70 watt medium amp source unit.
  - AM /FM tuner.
  - Expertly tuned for exceptional sound on the move in your Defender MAX.
  - Speakers include adjustable RGB LED cone illumination, controlled via an app on your smartphone.
  - Medium amp source unit equipped with 3" full color LCD display, with day/night lighting modes.
- Designed to not drain the battery.
  - Specific to the type of riding.
  - To install the Audio Roof with the following accessories, the Power Harnesses 715003094 & 715008781 are required:
  - Flip Glass Windshield Wiper & Washer Kit (715002441), Windshield Wiper & Washer Kit (715001638), Front Full Doors with Power Windows (715006331), Front Deluxe Full Doors (715005214), Rear Deluxe Full Doors (715005215)
  - Not compatible with Adventure Roof Rack.
  - Not compatible with 39 in. (99 cm) Double Stacked LED Light Bar (270 W) (715004007) & Light Bar Support (715006226).

|   |                        |           |                 |
|---|------------------------|-----------|-----------------|
| <b>Wetsound Stealth XT 6 Can-Am Edition Sound Bar</b> | Defender, Defender MAX | 715008282 | <b>\$759.99</b> |
|---|------------------------|-----------|-----------------|



- Built-in Bluetooth connectivity with source control.
  - Built-in Broadcast mode.
  - Backlit control panel with integrated LED RGB cabin lights.
  - Integrated LED Dome.
  - IP67 rated RF wireless remote control.
  - 3.5 aux input/output.
  - Built-in 300 W Class D Amp.
- 4 marine-rated 3" full range drivers.
  - 2 marine-rated 1" tweeters.
  - Operating voltage: 12 V.
  - IP rated: IP67.
  - Length: 21.31"
  - Width: 4.04"
  - Height: 3.85"
  - Sound Bar Mounting Kit required for installation.

|                               |                        |           |                |
|-------------------------------|------------------------|-----------|----------------|
| <b>Sound Bar Mounting Kit</b> | Defender, Defender MAX | 715007840 | <b>\$49.99</b> |
|-------------------------------|------------------------|-----------|----------------|



- Required to install the Wetsound Stealth XT 6 Can-Am Edition Sound Bar on a Defender and Defender MAX.

## Overhead Audio System



- Rugged waterproof Jensen® Bluetooth Stereo Audio System offers multi-source input: AM /FM /WB and USB (Pod and Phone ready).
  - Convenient white LED backlit LCD display and buttons.
  - Stream from any Bluetooth-enabled device (smartphone, MP3 player).
  - Powerful 4x40W amp with remote turn-on.
  - Voice control of AVRCP-active device.
- 30 programmable AM /FM stations with auto-store/preset scan.
  - Separate RCA audio output and input.
  - UV-resistant finish / corrosion-resistant components.
  - Requires Sport Roof (715002430) or Front Roof Liner (715008226) and Power Cable (715003094).

|                                       |                        |           |                   |
|---------------------------------------|------------------------|-----------|-------------------|
| <b>Complete Overhead Audio System</b> | Defender, Defender MAX | 715002019 | <b>\$1,119.99</b> |
|---------------------------------------|------------------------|-----------|-------------------|

- Complete with 4 ultra-sturdy outdoor speakers (2 front and 2 rear) and 4 black speaker boxes.

|                                    |                        |           |                 |
|------------------------------------|------------------------|-----------|-----------------|
| <b>Overhead Front Audio System</b> | Defender, Defender MAX | 715003095 | <b>\$929.99</b> |
|------------------------------------|------------------------|-----------|-----------------|

- Complete with 2 ultra-sturdy front outdoor speakers and black speaker box.



|                                       |                        |                  |                 |
|---------------------------------------|------------------------|------------------|-----------------|
| <b>Back-Up Monitor and Camera Kit</b> | Defender, Defender MAX | <b>715003834</b> | <b>\$629.99</b> |
|---------------------------------------|------------------------|------------------|-----------------|



- Fully waterproof rear view camera and monitor kit.
- The camera is one of the clearest and sharpest available on the market, with 250,000 pixel image resolution and a 2.1 mm lens with 130° viewing angle.
- Features 18 infrared lights that allow up to 50 ft. (15.24 m) visibility in complete darkness, an auto iris sensor that adapts to light intensity changes and an adjustable sunshade.
- 7" (17.78 cm) digital TFT LCD color monitor comes with power harness and can support up to two camera inputs.
- The camera can be mounted to monitor your cargo load or to see farther behind, and it can be mounted under the cargo box for hitching purpose.
- Not compatible with Defrost Heat and Ventilation System or HVAC.

|                       |   |                  |                   |
|-----------------------|---|------------------|-------------------|
| <b>Power Tilt Bed</b> | Defender (except 6x6), Defender MAX (2020 & up), Defender PRO | <b>715007096</b> | <b>\$1,199.99</b> |
|                       | Defender 6x6  | <b>715007204</b> |                   |



- Powerful cargo box tilt with dash-integrated switch.
- Electrical actuated hydraulics for a strong and quick tilting system.

|                                    |                  |                |
|------------------------------------|------------------|----------------|
| <b>Quick Connect Battery Cable</b> | <b>715005408</b> | <b>\$10.49</b> |
|------------------------------------|------------------|----------------|



- Quickly and easily connect and charge different batteries with your charger.
- Included in the Battery Charger/Maintainer.
- Sold individually.

|   |                  |                |
|---|------------------|----------------|
| <b>Quick Connect Cable with Battery Indicator</b> | <b>715006055</b> | <b>\$22.49</b> |
|---|------------------|----------------|



- Quickly and easily connect and charge different batteries with your charger.
- 3-color LED indicator provides constant battery health indication.
- Sold individually.

|                      |                        |                  |                |
|----------------------|------------------------|------------------|----------------|
| <b>3-Mode Switch</b> | Defender, Defender MAX | <b>715004445</b> | <b>\$37.99</b> |
|----------------------|------------------------|------------------|----------------|



- Switches quickly and conveniently between Normal/Work/Eco modes.
- Work mode: Reduced throttle sensitivity for smoother acceleration and reduced lag in pace.
- Eco mode: Increased fuel economy.
- In-dash plug-and-play mount.
- Standard on 2020 models.

|                             |                        |                  |                |
|-----------------------------|------------------------|------------------|----------------|
| <b>NEW Cellphone Holder</b> | Defender, Defender MAX | <b>715008786</b> | <b>\$99.99</b> |
|-----------------------------|------------------------|------------------|----------------|



- Water resistant door allows for perfect phone positioning.
- Features capacitive and resistive touch screen technology.
- Spring system in back plate automatically adjusts for thickness.
- Fits all cellphones within 7.2" (185 mm) x 3.3" (85 mm) x 0.6" (15 mm) dimensions.
- Works with almost all charger wires.
- Does not include cellphone or charging wires.
- Requires the RAM GPS Mount (715003325) bolted directly on the dashboard for the Cellphone Holder to be supported.

|                      |                  |                |
|----------------------|------------------|----------------|
| <b>RAM GPS Mount</b> | <b>715003325</b> | <b>\$68.99</b> |
|----------------------|------------------|----------------|



- Allows for GPS integration onto vehicle.
- Standard AMP S hole pattern for Garmin C made.



|   |  |                  |                 |
|---|--|------------------|-----------------|
| <b>Digitally Encoded Security System (D.E.S.S.™) Keys</b> | Defender, Defender M AX (2023 & prior),<br>Defender & Defender M AX 2024 (with HD 9 &<br>HD 10 engine) | <b>715002458</b> | <b>\$239.99</b> |
|---|--|------------------|-----------------|



- Top-security anti-theft protection for your vehicle.
- Encrypted chip technology restricts access to your vehicle's electronic ignition system.
- One vehicle/one code.
- A vibration/shock-resistant ball-and-socket design that ensures a reliable connection.
- 3 programmable modes:
  - Work mode: Limits vehicle speed to 40 kph (25 mph) but does not limit engine torque.
  - Normal mode: Limits vehicle speed to 70 kph (44 mph) and 50% torque reduction.
  - Performance mode: No restrictions.

|   |  |                  |                 |
|---|--|------------------|-----------------|
| <b>NEW Digitally Encoded Security System (D.E.S.S.™) Keys</b> | Defender,<br>Defender M AX 2024 (with HD 7 engine) | <b>715009300</b> | <b>\$239.99</b> |
|---|--|------------------|-----------------|

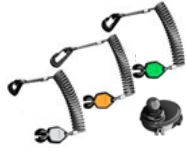

- Top-security anti-theft protection for Can-Am vehicles.
- The encrypted chip technology restricts access to the unit's electronic ignition system.
- One code per vehicle.
- Features a vibration/shock-resistant ball-and-socket design that ensures a reliable connection.
- Comes with three programmable keys, including:
  - Work key: configurable vehicle speed limit between 30 kph (18 mph) and maximum vehicle speed that does not limit engine torque.
  - Normal key: limits vehicle speed to 70 kph (44 mph) and 10% torque reduction on Defender models.
  - Performance key: no restrictions.

|   |  |                  |                 |
|---|--|------------------|-----------------|
| <b>Auxiliary Battery Installation Kit</b> | Defender, Defender M AX (2019 & prior) | <b>715003758</b> | <b>\$299.99</b> |
|   | Defender, Defender M AX (2020 & up)    | <b>715006035</b> | <b>\$369.99</b> |



- Allows you to add a second 30Ah battery for that dual battery setup that will give you the extra juice you'll need to power auxiliary electrical components like a sound system or winch.
- Additional battery sold separately (515176151).
- Equipped with an integrated smart battery isolator that will prevent your auxiliary electrical components from draining your starting battery.
- Kit includes an additional battery junction block, all necessary wiring and the battery holder.

|                             |                                     |                  |                |
|-----------------------------|-------------------------------------|------------------|----------------|
| <b>USB Power Outlet Kit</b> | Defender, Defender M AX (2020 & up) | <b>219400510</b> | <b>\$39.99</b> |
|-----------------------------|-------------------------------------|------------------|----------------|



- Recharges your electronic devices while riding\* (smartphone, MP3, heating gear, etc.).
- Dual port USB connectors.

\*The power outlet is not capable of recharging all device types while riding.

|   |   |                  |                   |
|---|---|------------------|-------------------|
| <b>Defrost, Heat &amp; Ventilation System</b> | Defender, Defender M AX 2019 & prior<br>(not compatible with HD 5 Motorization) | <b>715004917</b> | <b>\$1,519.99</b> |
|---|---|------------------|-------------------|



- Best integrated system on the market with 3-ventilation speed and in-dash adjustable temperature.
- Adjustable/directional vents.
- 10 vents specially positioned for better windshield and side window defrosting/defogging, foot and hand heat.
- Easy-service air filter.
- Once installed, you might want to add storage space with the Lower Dashboard for Heating System and Dash Storage Component Net for Heating System.

|  |                  |                   |
|--|------------------|-------------------|
| Defender, Defender M AX 2020 (except Defender PRO & HD 5 models) | <b>715005904</b> |                   |
| Defender, Defender M AX (2021 & up)                              | <b>715008093</b> | <b>\$1,619.99</b> |

- Best integrated in-dash system on the market with 3 fan speeds and adjustable temperature.
- Adjustable/directional vents can be closed to concentrate heat at specific areas.
- A total of 8 vents specially positioned for windshield and occupant heating.
- Easy-to-service air filter.
- Includes the replacement lower dashboard component for the heating system.
- Dash Storage Component Net for Heating System is recommended.

|                              |                         |                  |                 |
|------------------------------|-------------------------|------------------|-----------------|
| <b>Heated Steering Wheel</b> | Defender, Defender M AX | <b>715003837</b> | <b>\$469.99</b> |
|------------------------------|-------------------------|------------------|-----------------|



- Ruggedly constructed steering wheel designed to withstand cold conditions while channeling heat directly to your hands.
- Perfect for making hand mobility and grip readily available, e.g., hunting, manual farming.
- Replaces stock steering wheel.
- This kit includes the heated steering and in-dash switch.
- Draws a maximum of 45 W and 3.2 A at 13.5 V.
- Heated Accessory Electrical Harness (710005757) is required on all models except XT Cab 2020 & up and PRO models, which require Heated Accessories Wiring Harness (715006036).

|                              |   |                  |                |
|------------------------------|---|------------------|----------------|
| <b>Radiator Winter Front</b> | Defender, Defender MAX (2019 and prior) | <b>715005108</b> | <b>\$49.99</b> |
|------------------------------|---|------------------|----------------|



- Allows you to get higher heating temperatures out of the Defrost, Heat & Ventilation System in extremely cold conditions.

|                    |                        |                  |                 |
|--------------------|------------------------|------------------|-----------------|
| <b>Heated Seat</b> | Defender, Defender MAX | <b>715006112</b> | <b>\$139.99</b> |
|--------------------|------------------------|------------------|-----------------|



- 25 W seat heater delivers chill-free riding comfort.
- High/low temperature settings allow you to control the desired degree of warmth.
- This kit includes one carbon fiber seat heater, foam sheet and in-dash switch.
- Installs directly in the original seat cushion.
- Heated Accessories Wiring Harness (710005757) is required for installation on front seat.
- Heated Accessories Wiring Harness (715006036) is required for installation on Defender XT Cab, PRO and Limited models.
- Heated Accessories Wiring Harness (715006004) is required for installation on rear seats on MAX models.

|  |              |                  |                 |
|--|--------------|------------------|-----------------|
| <b>Heated Seat Harness for MAX Model</b><br><i>(Not illustrated)</i> | Defender MAX | <b>715006004</b> | <b>\$184.99</b> |
|--|--------------|------------------|-----------------|

- Electric harness required to hook up and operate rear heated seats.

|                            |                        |                  |                |
|----------------------------|------------------------|------------------|----------------|
| <b>Heated Visor Outlet</b> | Defender, Defender MAX | <b>715001246</b> | <b>\$56.99</b> |
|----------------------------|------------------------|------------------|----------------|



- Strategically positioned on vehicle to maintain your agility.
- Optional visor outlet that delivers fog-free riding.
- Quick and easy installation.
- Sold individually.
- Heated Visor not included.

|  |  |                  |                 |
|--|--|------------------|-----------------|
| <b>Heated Accessories Wiring Harness</b><br><i>(Not illustrated)</i> | Defender, Defender MAX (models with defrost, heat & ventilation system), ALL Defender PRO models | <b>715006036</b> | <b>\$194.99</b> |
|  | Defender, Defender MAX (models without defrost, heat & ventilation system)                       | <b>710005757</b> | <b>\$119.99</b> |

- Electric harness required to hook up and operate heated accessories.
- Power up to 4 accessories: 2 hand accessories (grab bar/steering wheel) and 2 seat covers.

# WINCHES & HITCHES



## Can-Am HD Winches

|                             |                        |                  |                 |
|-----------------------------|------------------------|------------------|-----------------|
| <b>Can-Am HD 4500 Winch</b> | Defender, Defender MAX | <b>715006416</b> | <b>\$359.99</b> |
|-----------------------------|------------------------|------------------|-----------------|



- Ergonomic clutch handle.
- Rugged all-steel gears and bushings form core torque and durability.
- Automatic 100% load-holding brake.
- Sealed solenoid for all-weather protection.
- Weather sealed corded remote and dash mounted switch.
- EC compliant.
- Pulling strength capability of 4,500 lb (2,041 kg).
- 43' of 1/2" (13.1 m of 6.3 mm) wire steel cable.
- Heavy-duty 4-way roller fairlead.
- Winch Electrical Harness (715007078) is required for installation on a Defender 2021 and prior. Winch Electrical Harness (715008152) is required for installation on a Defender Base and DPS 2022 & up.

|                               |                        |                  |                 |
|-------------------------------|------------------------|------------------|-----------------|
| <b>Can-Am HD 4500-S Winch</b> | Defender, Defender MAX | <b>715006417</b> | <b>\$479.99</b> |
|-------------------------------|------------------------|------------------|-----------------|



- Ergonomic clutch handle.
- Rugged all-steel gears and bushings form core torque and durability.
- Automatic 100% load-holding brake.
- Sealed solenoid for all-weather protection.
- Weather sealed corded remote and dash mounted switch.
- Pulling strength capability of 4,500 lb (2,041 kg).
- 50' of 3/4" (15.2 m of 6.35 mm) synthetic rope.
- Corrosion-proof aluminum hawse fairlead.
- Winch Electrical Harness (715007078) is required for installation on a Defender 2021 and prior. Winch Electrical Harness (715008152) is required for installation on a Defender Base and DPS 2022 & up.

# WARN<sup>+</sup> VRX Winches

## WARN VRX 45 Winch



Defender, Defender MAX (except XT Cab 2018-2019, Lone Star Edition, XM<sup>+</sup>, Limited, DPS Cab & Hunting Edition 2020 & up)

715006110

\$609.99

- Extreme IP68-rated waterproof sealing keeps the elements out.
- Durable aluminum construction.
- Black powder-coated finish and stainless steel fasteners for corrosion resistance.
- Robust new clutch design based on 70+ years of WARN 4WD hub lock know-how.
- Load-holding brake for great control.
- Smooth and reliable aluminum three-stage planetary gear train.
- Dash-mounted rocker control.
- Limited lifetime warranty (mechanical), 3-year warranty (electrical).
- Pulling strength capability of 4,500 lb (2,041 kg).
- 50' of 1/2" (15 mm of 6.3 mm) wire steel cable.
- Roller fairlead.
- Winch Electrical Harness (715007078) is required for installation on a Defender 2021 and prior. Winch Electrical Harness (715008152) is required for installation on a Defender 2022 & up.

## WARN VRX 45-S Winch



Defender, Defender MAX (except XT Cab 2018-2019, Lone Star Edition, XM<sup>+</sup>, Limited, DPS Cab & Hunting Edition 2020 & up)

715006111

\$729.99

- Extreme IP68-rated waterproof sealing keeps the elements out.
- Durable aluminum construction.
- Black powder-coated finish and stainless steel fasteners for corrosion resistance.
- Robust new clutch design based on 70+ years of WARN 4WD hub lock know-how.
- Load-holding brake for great control.
- Smooth and reliable aluminum three-stage planetary gear train.
- Dash-mounted rocker control.
- Limited lifetime warranty (mechanical), 3-year warranty (electrical).
- Pulling strength capability of 4,500 lb (2,041 kg).
- 50' of 1/2" (15 mm of 6.3 mm) synthetic rope.
- Cast aluminum Hawse fairlead.
- Winch Electrical Harness (715007078) is required for installation on a Defender 2021 and prior. Winch Electrical Harness (715008152) is required for installation on a Defender 2022 & up.

## Cargo Bed Winch



Defender, Defender MAX

715006355

\$669.99

- Allows you to pull heavy loads into the cargo box easily.
- Perfect for hunting applications, i.e., loading game.
- Includes support base made of heavy-duty 2" (5 cm) steel tubing, winch and weather-sealed corded remote.
- 750 lb (340 kg) maximum pulling capacity.
- Electronic security module to prevent vehicle damage that could occur if loaded vehicle exceeds manufacturer's gross weight rating.
- Adapter Kit (715004709) required for installation with GearRail Adapter.
- Requires PowerTilt bed for Defender 6x6 and PRO.
- Not EC compliant.

## Synthetic Winch Cable\*



With WARN winch

715007783

\$164.99

- 50' of 1/2" (15.2 mm of 6.35 mm) synthetic cable for WARN winch.
- WARN Hawse Fairlead is required when upgrading to a synthetic cable to avoid damage and premature wear of the cable.

\*Ask your dealer or visit [canamoffroad.com](http://canamoffroad.com) for price details.

## Synthetic Winch Cable\*



With Can-Am HD winch

715006430

\$149.99

- 50' of 1/2" (15.2 mm of 6.35 mm) synthetic cable for Can-Am HD winches.
- Hawse Fairlead (715006426) required when upgrading to a synthetic cable to avoid premature cable damage and wear.

\*Ask your dealer or visit [canamoffroad.com](http://canamoffroad.com) for price details.

## Synthetic Cable Extension



715001120

\$169.99

- Lightweight 1/2" (6.35 mm) diameter, easy to handle and won't rattle in cargo box.
- Easily attaches to winch cable to provide additional 50' (15.2 m) of distance.
- 4,500 lb (2,041 kg) single line capacity.

|                               |                 |                  |                |
|-------------------------------|-----------------|------------------|----------------|
| <b>Replacement Wire Rope*</b> | With WARN winch | <b>715006699</b> | <b>\$80.99</b> |
|-------------------------------|-----------------|------------------|----------------|



- 55' of 1/2" (1.68 m of 6.35 mm) wire rope for WARN winch kit.
- 4,500 lb (2,041 kg) pulling strength.

\*Ask your dealer or visit [canamoffroad.com](http://canamoffroad.com) for price details.

|                               |                      |                  |                |
|-------------------------------|----------------------|------------------|----------------|
| <b>Replacement Wire Rope*</b> | With Can-Am HD winch | <b>705014978</b> | <b>\$22.49</b> |
|-------------------------------|----------------------|------------------|----------------|



- 43' of 1/2" (1.31 m of 6.3 mm) wire rope.
- 4,500 lb (2,041 kg) pulling strength.

\*Ask your dealer or visit [canamoffroad.com](http://canamoffroad.com) for price details.

|                             |                 |                  |                 |
|-----------------------------|-----------------|------------------|-----------------|
| <b>WARN Hawse Fairlead*</b> | With WARN winch | <b>715007785</b> | <b>\$109.99</b> |
|-----------------------------|-----------------|------------------|-----------------|



- Double-powder-coated construction.
- Required to use the Synthetic Winch Cable (715007783) on WARN winches.
- To be used with synthetic winch cables only.

|                                 |                      |                  |                |
|---------------------------------|----------------------|------------------|----------------|
| <b>Can-Am HD Hawse Fairlead</b> | With Can-Am HD winch | <b>715006426</b> | <b>\$57.99</b> |
|---------------------------------|----------------------|------------------|----------------|



- A must when upgrading your winch with a synthetic cable, this corrosion-proof aluminum hawse fairlead will prevent the cable from snapping in a corner of a roller fairlead and from wearing prematurely due to the rough surface of the worn roller guide.
- Must be used with synthetic cables only.

|                        |                      |                  |                |
|------------------------|----------------------|------------------|----------------|
| <b>Roller Fairlead</b> | With Can-Am HD winch | <b>710007082</b> | <b>\$55.99</b> |
|------------------------|----------------------|------------------|----------------|



- Suggested when changing the wire rope.
- Heavy-duty replacement fairlead for winches.

|                             |                      |                  |                |
|-----------------------------|----------------------|------------------|----------------|
| <b>Wired Remote Control</b> | With Can-Am HD winch | <b>715006504</b> | <b>\$24.99</b> |
|-----------------------------|----------------------|------------------|----------------|



- This kit allows winch owners to add the hand-held remote to vehicles with a stock winch.
- Works in conjunction with the mini rockerswitch.
- Remote control and connection socket are included with Can-Am HD winch.
- EC compliant.

|                                |   |                  |                 |
|--------------------------------|---|------------------|-----------------|
| <b>Wireless Remote Control</b> | With WARN winch (Defender 2019 & prior) | <b>715002542</b> | <b>\$214.99</b> |
|--------------------------------|---|------------------|-----------------|



- The system is quick and easy to install, thanks to a wiring harness with an integrated antenna and all necessary mounting hardware.
- Allows you to operate your winch from anywhere within a 50' (15.2 m) radius, increasing your recovery options.
- All components are weatherproof.

|                                   |                        |                  |                 |
|-----------------------------------|------------------------|------------------|-----------------|
| <b>Lower Front Receiver Hitch</b> | Defender, Defender MAX | <b>715002519</b> | <b>\$119.99</b> |
|-----------------------------------|------------------------|------------------|-----------------|



- Heavy-duty 1,500 lb (680 kg) towing capacity 2" (5 cm) receiver hitch.
- Expand and enhance functionality by pairing it with Higher Front Receiver Hitch and Removable Winch Mounting Kit (need to relocate winch from its standard mounting position).



### Higher Front Receiver Hitch

Defender, Defender M AX (except Limited models)

715003109

\$119.99



- Heavy-duty 1,500 lb (680 kg) towing capacity 2" (5 cm) receiver hitch.
- No need to relocate winch from its standard mounting position.

### Winch Electrical Harness

(Not illustrated)

Defender, Defender M AX (2019 & prior)

715003093

\$57.99

Defender, Defender M AX (2020 & 2021)

715007078

\$119.99

Defender, Defender M AX 2022

715008152

\$109.99

- Required to install a winch on a Defender without a factory-installed winch.

### Front and Rear Hitch Drawbar

Defender, Defender M AX

715008350

\$99.99



- Standard on 2" (5 cm) receiver hitch.
- Offers 1,650 lb (750 kg) of towing capacity.
- Hitch ball not included.
- Forged steel.

### Rubber Receiver Plug

705204503

\$12.99



- Rubber cap for 2" (5 cm) Receiver Hitch.

## PERFORMANCE

### Performance Half Shaft

Defender and Defender M AX (2019 & prior -except X m r, XTP and XT CAB 2018-2019)

705402353

Defender, Defender M AX XT Cab 2018-2019, Lone Star Edition 2019 & prior

705402575

\$229.99



- High-performance design ideal for off-road use, with superior wheel power and acceleration for racing, dunes and desert riding.
- Includes CVs, shaft and boots with the best suited geometry for your Can-Am vehicle.

### Brake Holding Mechanism

Defender, Defender M AX

715004733

\$39.99



- Maintains constant pressure on the brake pedal to keep the vehicle from moving on sloped terrain, without having to put the transmission in Park.

### Heavy-Duty Spring Kit

Defender Base, DPS (HD5, HD7, HD8 & HD9), XT (HD7, HD8 & HD9) & PRO (HD8). Except Defender M AX, 6x6 and Defender PRO).

715005084

\$289.99



- This set of heavy-duty springs will stiffen your suspension.
- Perfect for reducing vehicle overall sag when shocks are under heavy demand: heavy loading and hauling or for snow clearing.
- Complete kit of 4 springs.
- Not compatible with Defender HD5, XT CAB, Mossy Oak Edition & X m r models and Defender M AX.

|                          |   |                  |                 |
|--------------------------|---|------------------|-----------------|
| <b>850 W Magneto Kit</b> | Defender, DefenderM AX (2020 & up except HD5 & HD7) | <b>715007122</b> | <b>\$749.99</b> |
|--------------------------|---|------------------|-----------------|



- Increases the magneto output to 850 W.
- Includes rotor, stator and regulator.

|                      |                        |                  |                 |
|----------------------|------------------------|------------------|-----------------|
| <b>Emergency Kit</b> | Defender, DefenderM AX | <b>715006102</b> | <b>\$159.99</b> |
|----------------------|------------------------|------------------|-----------------|



- Complete emergency kit provides all essential equipment and supplies to get out of most unfavorable situations power sport enthusiasts can find themselves in.
- Includes: jimmy cables, air compressor, tire repair kit, first aid kit, ratchet tie-down, duct tape, tow strap 3,300 lb (1,500 kg), zip-ties, cloth rags.

## Air Intakes & Exhaust

|                    |   |                  |                 |
|--------------------|---|------------------|-----------------|
| <b>Snorkel Kit</b> | Defender, DefenderM AX (except Defender HD5, HD7 and DefenderPRO) | <b>715003727</b> | <b>\$739.99</b> |
|--------------------|---|------------------|-----------------|



- Raises point of engine and CVT air intakes so vehicle can be semi-submerged in water/mud without taking in water to the engine.
- Not compatible with Headache Racks, Gear Rail equipment, DragonFire Cargo Bed Roll Bar and Windshield Wiper & Washer Kit.
- Snorkel Extension Kit is available for roof level air intake and CVT exhaust.
- Adapter for Snorkel Kit (715004414) and Sealed Air Box (707801033) are required for installation on 2017 and prior models.
- Standard on Defender X models.

|                           |                        |                  |                 |
|---------------------------|------------------------|------------------|-----------------|
| <b>Snorkel Extensions</b> | Defender, DefenderM AX | <b>715004415</b> | <b>\$249.99</b> |
|---------------------------|------------------------|------------------|-----------------|



- Extend the Snorkel Kit for roof engine and CVT air intake.
- Add aggressive look to your vehicle and help keep your intakes clear from mud, snow, dust, etc. in severe riding conditions.
- Not compatible with all rear panels and windows, Rear Cargo Light and roof mounted Rear View Camera.
- Snorkel Kit (715003727) is required, except for X models.

|  |  |                  |                 |
|--|--|------------------|-----------------|
| <b>Adapter for Snorkel Kit</b><br><i>(Not illustrated)</i> | Defender and DefenderM AX 2017 & prior | <b>715004414</b> | <b>\$109.99</b> |
|--|--|------------------|-----------------|

- Required for the installation of Snorkel Kit (715003727) on Defender 2017 and prior models.
- Includes rear fender rail for Snorkel Kit and hardware.
- Standard on Defender 2018 & up models.

|   |                                     |                  |                 |
|---|-------------------------------------|------------------|-----------------|
| <b>Sealed Air Box</b><br><i>(Not illustrated)</i> | Defender, DefenderM AX 2017 & prior | <b>707801033</b> | <b>\$169.99</b> |
|---|-------------------------------------|------------------|-----------------|

- Required when installing the Snorkel Kit (715003727) on Defender and DefenderM AX 2017 and prior models.
- Standard on Defender 2018 & up models.

|                           |   |                  |                |
|---------------------------|---|------------------|----------------|
| <b>Snorkel Pre-FILTER</b> | Defender, DefenderM AX (except DefenderPRO) | <b>715005597</b> | <b>\$98.99</b> |
|---------------------------|---|------------------|----------------|



- Pre-filters specifically for snorkels.
- Adds extra protection to your engine in harsh riding conditions.
- Helps keep air filter cleaner.
- Filter blocks particles larger than 0.005" (0.13 mm).
- Necessary to maintain vehicle warranty when tracks are installed for winter use.
- For Defender and Tracker HD 10 models 2020 & up: Replace CVT intake of snorkel kit with CVT recombination kit 715008651 or 703501211.

|                              |  |                  |                |
|------------------------------|--|------------------|----------------|
| <b>Air Intake Pre-Filter</b> | Defender (except X models), DefenderM AX | <b>715003483</b> | <b>\$51.99</b> |
|------------------------------|--|------------------|----------------|



- Adds extra protection to your engine in harsh riding conditions.
- Helps keep air filter cleaner.
- Filter blocks particles larger than 0.007" (0.19 mm).
- Easy, tool-less installation.
- Necessary to maintain vehicle warranty when tracks are installed.
- Required to install the Apache and Backcountry Track Systems.
- Not compatible with Snorkel Kit.

|  |                         |           |          |
|--|-------------------------|-----------|----------|
| <b>Foam Air Filter by Twin AIR<sup>®</sup></b> | Defender, Defender M AX | 715003630 | \$119.99 |
|--|-------------------------|-----------|----------|



- The best choice for the harshest conditions.
- Multiple staged oiled filtering foam for superior dust retaining capacity with high air flow.
- Washable and reusable.

|  |   |             |          |
|--|---|-------------|----------|
| <b>NEW CVT Air Intake Relocation Kit</b> | Defender, Defender M AX (without Snorkel Kit)                 | 703501210   | \$184.99 |
|  | Defender, Defender M AX (X models or models with Snorkel Kit) | 703501211** |          |



- The CVT air intake relocation kit is MANDATORY for track-equipped 2020 to 2022 and some 2023\* Defender and Traxter HD10 models used in snow conditions and highly recommended for other models.
- This kit is sold separately.

\*Comes from the factory on some MY23; inspect the vehicle to confirm.  
Mandatory on all MY20 and up Defender and Traxter HD10 models equipped with a snorkel.  
\*\*When installed, it temporarily relocates CVT air intake to the standard factory location.

# APACHE TRACK SYSTEMS



## Winter Tracks

## Limited Warranty\*

|  |                                      |           |
|--|--------------------------------------|-----------|
| <b>Apache BackCountry LT Track Kit</b> | Defender, Defender M AX (except 6x6) | 715005891 |
|--|--------------------------------------|-----------|



- Tracks designed to deliver the best snow performance on the market with unmatched flotation, level and traction on snow surface.
- Large contact patch, 37% bigger than the Apache 360 LT.
- Ingressive added ground clearance of 7" (18 cm) helps keep the vehicle over the snow.
- Lightweight snowmobile-inspired rail design.
- Aggressive track design with 2" (5 cm) lug height for maximum traction on snow.
- Apache BackCountry LT Mounting Kit, Track DPS Module and Engine Pre-Filter are required and sold separately.
- The CVT air intake relocation kit is MANDATORY for track-equipped 2020 to 2022 and some 2023\* Defender and Traxter HD10 models and highly recommended for other models. This kit is sold separately.
- For winter use only.
- Track installation will affect vehicle width and length.
- Fine-tune your track system using extra HlerW heels, Siders with Vespel Inserts and Rail Ice Scratcher.

\*Comes from the factory on some MY23; inspect the vehicle to confirm.  
Mandatory on all MY20 & up Defender and Traxter HD10 models equipped with a snorkel.

|  |  |                                     |
|--|--|-------------------------------------|
| <b>Apache BackCountry LT Mount Kit</b><br><i>(Not illustrated)</i> | See table for fit, compatibility and requirements. | 715005888<br>715005493<br>715006196 |
|--|--|-------------------------------------|

- Required for installation of the Apache BackCountry Track LT System.
- DPS Module and Engine Pre-Filter are required and sold separately.
- The CVT air intake relocation kit is MANDATORY for track-equipped 2020 to 2022 and some 2023\* Defender and Traxter HD10 models and highly recommended for other models. This kit is sold separately.

\*Comes from the factory on some MY23; inspect the vehicle to confirm.  
Mandatory on all MY20 & up Defender and Traxter HD10 models equipped with a snorkel.

|                            |   |           |
|----------------------------|---|-----------|
| <b>Rail Ice Scratchers</b> | Apache BackCountry and BackCountry LT Track Systems | 860201728 |
|----------------------------|---|-----------|



- Provide additional lubrication in hard and icy conditions and extend slider life.
- Rail mounted, small, light.
- Design expands on coil concept to allow reversing without damage.
- Easily stored when not in use.

|                        |                                 |           |
|------------------------|---------------------------------|-----------|
| <b>Extra Wheel Kit</b> | Apache BackCountry LT Wheel Kit | 715006293 |
|------------------------|---------------------------------|-----------|



- Additional wheel kit for BackCountry LT rear tracks.
- Reduces drag and rolling resistance in hard snow conditions or when transporting heavier loads.
- Extends slider life in hard snow conditions.
- Includes two wheels, cross shaft and mounting hardware per kit to service one track corner.
- Up to two kits per rear track can be installed.

\*The limited warranty is subject to the exclusions, limitations of liabilities and all other terms and conditions of BRP's standard limited warranty.

## Apache Backcountry LT Tracks Fitting Guide

| Model Year / Model   | Length | Track     | Track Mount | Track DPS Module | CVT Pre-Filter   | Engine Pre-Filter  |
|--|--------|-----------|-------------|------------------|--|--|
| 2019 & Prior<br>DefenderBase,DPS,XT,XT Cab 2017<br>& Hunting Edition,XT-P  | 62"    | 715005891 | 715005888   | 715007338        | 703501210<br>(w / SnorkelKit)<br>703501211<br>(w / SnorkelKit) | 715005597<br>(w / SnorkelKit)<br>715003483<br>(w / SnorkelKit) |
| 2019 & Prior<br>DefenderXT Cab 2018-2019,<br>Lone StarEdition & X m r  | 67"    |           | 715006196   |                  |  |  |
| 2020 & Up<br>DefenderBase,DPS (HD 5,HD 7,HD 8<br>& HD 9),XT (HD 8 & HD 9)  | 62"    |           | 715005888   |                  |  |  |
| 2020 & Up<br>DefenderDPS (HD 10),XT (HD 10),<br>XT-P,PRO DPS,PRO XT  | 64"    |           | 715005493   |                  |  |  |
| 2020 to 2022<br>DefenderXT Cab,XT Cab Limited,<br>Hunting Edition,Lone StarEdition,<br>X m r,PRO Limited,PRO Lone Star | 67"    |           | 715006196   |                  |  |  |
| 2023 & Up<br>DefenderXT Cab,XT Cab Limited,<br>Hunting Edition,Lone StarEdition,<br>X m r,PRO Limited,PRO Lone Star    | 67"    |           | 715005493   |                  |  |  |
| 2024<br>DefenderHD 7   | 62"    |           | 715005888   |                  |  |  |

## Year-Round Tracks

## Limited Warranty\*

### Apache 360 LT Track System

Defender,DefenderMAX (except 6x6)

715005103



- Multifunctional tracks designed to support heavy loads and to fit on most Can-Am off-road vehicles.
- Extra contact patch adjustment for better performance over rough terrain.
- Contact patch is 7 to 9% bigger than the Apache 360's.
- Average ground clearance of 16" (41 cm), 1" (2.5 cm) lugs in the front and 1.25" (3.2 cm) in the back.
- EC compliant.
- Apache 360 LT Mounting Kit, Track DPS Module and Engine Pre-Filter Kit are required and sold separately.

- The CVT air intake relocation kit is MANDATORY for track-equipped 2020 to 2022 and some 2023 Defender and Traxter HD 10 models used in snow conditions and highly recommended for other models. This kit is sold separately.

\*Comes from the factory on some MY23, inspect the vehicle to confirm.

Mandatory on all MY20 & up Defender and Traxter HD10 models equipped with a snorkel.

### Apache 360 LT Mounting Kit

(Not illustrated)

See table for fit, compatibility and requirements.

715004832

715004831

715005492

- Required for installation of the Apache 360 LT Track System.
- DPS module and Engine Pre-Filter not included.
- The CVT air intake relocation kit is MANDATORY for track-equipped 2020 to 2022 and some 2023 Defender and Traxter HD 10 models used in snow conditions and highly recommended for other models.

- This kit is sold separately.

\*Comes from the factory on some MY23, inspect the vehicle to confirm.

Mandatory on all MY20 & up Defender and Traxter HD10 models equipped with a snorkel.

### Track DPS Module

(Not illustrated)

715007338

- An innovative DPS module that ensures speedometer accuracy and optimized steering assist, which make for perfect track control and riding ease.
- Required to install the Apache and Backcountry Track Systems.

\*The limited warranty is subject to the exclusions, limitations of liabilities and all other terms and conditions of BRP's standard limited warranty.



## Apache 360 LT Tracks Fitting Guide

| Model Year / Model   | Length | Track     | Track Mount | Track DPS Module | CVT Pre-Filter  | Engine Pre-Filter   |
|--|--------|-----------|-------------|------------------|---|---|
| 2019 & Prior<br>DefenderBase,DPS,XT,XT Cab 2017<br>& Hunting Edition,XT-P  | 62"    | 715005103 | 715004831   | 715007338        | 703501210<br>(w /o SnorkelKit)<br>703501211<br>(w / SnorkelKit) | 715005597<br>(w / SnorkelKit)<br>715003483<br>(w /o SnorkelKit) |
| 2019 & Prior<br>DefenderXT Cab 2018-2019,<br>Lone StarEdition & X m r  | 64"    |           | 715004832   |                  |   |   |
| 2020 & Up<br>DefenderBase,DPS (HD5,HD7,HD8<br>& HD9),XT (HD8 & HD9)  | 62"    |           | 715004831   |                  |   |   |
| 2020 & Up<br>DefenderDPS (HD10),XT (HD10),<br>XT-P,PRO DPS,PRO XT  | 64"    |           | 715005492   |                  |   |   |
| 2020 to 2022<br>DefenderXT Cab,XT Cab Limited,<br>Hunting Edition,Lone StarEdition,<br>X m r,PRO Limited,PRO Lone Star | 67"    |           | 715004832   |                  |   |   |
| 2023 & Up<br>DefenderXT Cab,XT Cab Limited,<br>Hunting Edition,Lone StarEdition,<br>X m r,PRO Limited,PRO Lone Star    | 67"    |           | 715005492   |                  |   |   |
| 2024<br>DefenderHD7  | 62"    |           | 715004831   | 715006266        |   |   |



## Can-Am ProMount Flex2 Plow Kit

|  |                        |           |            |
|--|------------------------|-----------|------------|
| <b>Can-Am ProMount Flex2 72" (183 cm) Blade Plow Kit</b> | Defender, Defender MAX | 715008170 | \$1,319.97 |
|--|------------------------|-----------|------------|



- These kits include:
  - Can-Am ProMount Flex2 Blade
  - Push Frame with Quick-Attach System
  - Mounting Plate

## Can-Am ProMount Flex2 Blades

|   |                          |           |          |
|---|--------------------------|-----------|----------|
| <b>Can-Am ProMount Flex2 66" (168 cm) Blade</b> | Fits ProMount Push Frame | 715006265 | \$509.99 |
|---|--------------------------|-----------|----------|



- Plow blade made of UHMWPE, flexible and impact absorbing material prevents damaging your plow when accidental impact occurs.
- Replaceable wearblade.
- Large pin designed for easy blade rotation to eliminate snow buildup at pivot point.
- Blade design provides best snow roll-off at any angle.
- Clears 60" (152 cm) when plow is fully angled.
- Blade height of 17" (43 cm).
- Compatible with Can-Am ProMount Blade accessories to further enhance plow versatility.

|   |                          |           |          |
|---|--------------------------|-----------|----------|
| <b>Can-Am ProMount Flex2 72" (183 cm) Blade</b> | Fits ProMount Push Frame | 715004485 | \$589.99 |
|---|--------------------------|-----------|----------|



- Plow blade made of UHMWPE, flexible and impact absorbing material prevents damaging your plow when accidental impact occurs.
- Replaceable wearblade.
- Large pin designed for easy blade rotation to eliminate snow buildup at pivot point.
- Blade design provides best snow roll-off at any angle.
- Clears 66" (168 cm) when plow is fully angled.
- Blade height of 17" (43 cm).
- Compatible with Can-Am ProMount Blade accessories to further enhance plow versatility.

## Can-Am ProMount Steel Plow Kit

|  |                        |   |  |
|--|------------------------|---|--|
| <b>Can-Am ProMount Steel 72" (183 cm) Blade Plow kit</b> | Defender, Defender MAX | <ul style="list-style-type: none"> <li>■ 715008172 - Black</li> <li>■ 715008171 - Yellow</li> </ul> | <ul style="list-style-type: none"> <li>\$1,209.97</li> <li>\$1,204.97</li> </ul> |
|--|------------------------|---|--|



- These kits include:
  - Can-Am ProMount Steel Blade
  - Push Frame with Quick-Attach System
  - Mounting Plate

## Can-Am ProMount Steel Blades

|   |                          |   |          |
|---|--------------------------|---|----------|
| <b>Can-Am ProMount Steel 66" (168 cm) Blade</b> | Fits ProMount Push Frame | <ul style="list-style-type: none"> <li>■ 715006337 - Black</li> <li>■ 715006338 - Yellow</li> </ul> | \$409.99 |
|---|--------------------------|---|----------|



- Plow blade made from 12-gauge steel.
- Replaceable wearblade.
- Large pin designed for easy blade rotation to eliminate snow buildup at pivot point.
- Blade design provides best snow roll-off at any angle.
- Clears 60" (152 cm) when plow is fully angled.
- Blade height of 17" (43 cm).
- Compatible with Can-Am ProMount Blade accessories to further enhance plow versatility.
- Not compatible with S3 High Clearance Front-A-AM.

|   |                          |   |          |
|---|--------------------------|---|----------|
| <b>Can-Am ProMount Steel 72" (183 cm) Blade</b> | Fits ProMount Push Frame | <ul style="list-style-type: none"> <li>■ 715004474 - Black</li> <li>■ 715006021 - Yellow</li> </ul> | \$479.99 |
|---|--------------------------|---|----------|



- Plow blade made from 12-gauge steel.
- Replaceable wearblade.
- Large pin designed for easy blade rotation to eliminate snow buildup at pivot point.
- Blade design provides best snow roll-off at any angle.
- Clears 66" (168 cm) when plow is fully angled.
- Blade height of 17" (43 cm).
- Compatible with Can-Am ProMount Blade accessories to further enhance plow versatility.
- Not compatible with S3 High Clearance Front-A-AM.

## ProMount Plow Kits - Reference Charts

|                | 66" Black Steel | 66" Yellow Steel | 66" Flex2 | 72" Black Steel | 72" Yellow Steel | 72" Flex2 |
|----------------|-----------------|------------------|-----------|-----------------|------------------|-----------|
| Plow Kit       | -               | -                | -         | 715008172       | 715008171        | 715008170 |
| Blade          | 715006337       | 715006338        | 715006265 | 715004474       | 715006021        | 715004485 |
| Push Frame     | 715008116       | 715008116        | 715008116 | 715008116       | 715008116        | 715008116 |
| Mounting Plate | 715007745       | 715007745        | 715007745 | 715007745       | 715007745        | 715007745 |

## Can-Am ProMount Angle Plows

### Can-Am ProMount 66" (168 cm) Steel Oneway State Blade

Fits ProMount Push Frame

715007263

\$489.99



- Make the job easier with the right tools, clearing alleys and make the task easier by sending the snow further out of the way.
- Wing end of plow measures 26" (67 cm) high and tapers down to 16" (41 cm).

- One-way "winged" state plow designed to throw snow higher.
- Rubber Flap (715007299) designed to keep snow away from the driver is offered as accessory (sold separately).
- Can-Am branded.

### Can-Am ProMount 72" (183 cm) Steel Oneway State Blade

Fits ProMount Push Frame

715007264

\$539.99



- Make the job easier with the right tools, clearing alleys and make the task easier by sending the snow further out of the way.
- Wing end of plow measures 26" (67 cm) high and tapers down to 16" (41 cm).

- One-way "winged" state plow designed to throw snow higher.
- Rubber flap (715007299) designed to keep snow away from the driver is offered as accessory (sold separately).
- Can-Am branded.

## Can-Am ProMount Plow Accessories

### Can-Am ProMount Edge Markers

Defender, Defender MAX

715004206

\$45.99



- Help locate the edges of your plow.
- Height: 24" (60 cm).
- Sold in pairs.
- Compatible with Can-Am ProMount Steel and Flex2 blades with or without Blade Extensions (except for the Can-Am ProMount Steel 54" (137 cm) Blades).

### Can-Am ProMount 66" (168 cm) Plastic Wear Blade

Defender, Defender MAX

715004482

\$179.99

### Can-Am ProMount 72" (183 cm) Plastic Wear Blade

Defender, Defender MAX

715004483

\$199.99



- To help prevent scratches on smooth driveways and markable surfaces.

### Can-Am ProMount Drift Cutters

Defender, Defender MAX

715006258

\$159.99



- Help keep snow in the plow.
- Dimensions: 17" x 13" (43.2 cm x 33 cm).
- Sold in pairs.
- Compatible with Can-Am ProMount Steel and Flex2 blades with or without Blade Extensions (except for the Can-Am ProMount Steel 54" (137 cm) Blades).

|   |                       |   |                 |
|---|-----------------------|---|-----------------|
| <b>Can-Am ProMount Blade Extensions</b> | Defender, DefenderMAX | <ul style="list-style-type: none"> <li>■ 715004205 - Black</li> <li>■ 715005319 - Yellow</li> </ul> | <b>\$119.99</b> |
|---|-----------------------|---|-----------------|



- Add 3" (8 cm) each side.
- Compatible with Can-Am ProMount Blades (except for Can-Am ProMount Steel 54" [137 cm] Blade).
- Longer Wear Blade can be installed to further extend the extra length already provided by the extensions.
- Compatible with Can-Am ProMount Steel and Flex 2 Blades (except for the Can-Am ProMount Steel 54" [137 cm] Blades).

|  |                               |                  |                 |
|--|-------------------------------|------------------|-----------------|
| <b>Back Drag Blade</b><br><i>(Not illustrated)</i> | ProMount Plows (60" and more) | <b>715007794</b> | <b>\$279.99</b> |
|--|-------------------------------|------------------|-----------------|

- Thick steel swivel scraper.
- Lifts up when the vehicle is moving forward so as not to affect the scraping.
- Increased capacity to pull snow.
- More aggressive scraping in reverse mode.
- Lifts the scraper off the ground so that it scrapes evenly.
- Adjustable in length for compatibility with 60", 66" and 72" blades.
- Compatible with ProMount blades (Flex and Steel).

|  |                       |                  |                 |
|--|-----------------------|------------------|-----------------|
| <b>Can-Am ProMount Push Frame with Quick-Attach System</b> | Defender, DefenderMAX | <b>715008116</b> | <b>\$559.99</b> |
|--|-----------------------|------------------|-----------------|



- Heavy-duty steel tubes designed to withstand the roughest use.
- Mounting carriage provides ultimate push strength and traction.
- Designed for maximum plow lift height.
- Features a self-aligning quick-attach system, an easy foot release pedal and an ergonomic handle for plow angle adjustment.
- Plow Lin it Sw itch recommended to extend w inch cable lifespan.
- Can-Am ProMount Mounting Plate required for installation.
- Blade swivels left or right, 5 positions.
- Large pin designed for easy blade rotation to eliminate dirt and snow buildup at pivot point.

|   |                       |                  |                 |
|---|-----------------------|------------------|-----------------|
| <b>Can-Am ProMount Push Frame Extension</b> | Defender, DefenderMAX | <b>715006257</b> | <b>\$174.99</b> |
|---|-----------------------|------------------|-----------------|



- 12" (30 cm) push frame extension required when plow is installed with Apache Track System.

|                                       |                                      |                  |                 |
|---------------------------------------|--------------------------------------|------------------|-----------------|
| <b>Can-Am ProMount Mounting Plate</b> | Defender, DefenderMAX (2021 & prior) | <b>715007743</b> | <b>\$164.99</b> |
|---------------------------------------|--------------------------------------|------------------|-----------------|



- Required to install the Can-Am ProMount Push Frame with Quick-Attach System.
- Mounting plate precision-designed to stay on year-round without compromising ground clearance.
- Comes with the Plow Roller Fairlead.
- Not compatible with S3 Front High Clearance A-Arm (715003784).

|                                       |                                   |                  |                 |
|---------------------------------------|-----------------------------------|------------------|-----------------|
| <b>Can-Am ProMount Mounting Plate</b> | Defender, DefenderMAX (2022 & up) | <b>715007745</b> | <b>\$169.99</b> |
|---------------------------------------|-----------------------------------|------------------|-----------------|



- Required to install the Can-Am ProMount Push Frame with Quick-Attach System.
- Mounting plate precision-designed to stay on year-round without compromising ground clearance.
- Comes with the Plow Roller Fairlead.
- Not compatible with S3 Front High Clearance A-Arm (715003784).

|  |                       |                  |                   |
|--|-----------------------|------------------|-------------------|
| <b>Can-Am ProMount Plow Angling System</b> | Defender, DefenderMAX | <b>715009241</b> | <b>\$1,099.99</b> |
|--|-----------------------|------------------|-------------------|



- Converts your plow system into an easy-to-control unit from the driver's seat.
- Allows you to have full up/down and left/right plow control at your fingertips with the supplied joystick.
- Using one hand to control all plow motions allows you to easily concentrate and manage your plowing tasks.
- Compatible with the SxS ProMount Push Frame and Blade.
- Not compatible with Apache Backcountry LT Track System.
- Push Frame Extension (715006257) is required for installation with the Front Rancher bumper.
- Winch and plow sold separately.



## ProMount Plow Limit Switch

(Not illustrated)

Defender, Defender MAX

715006259

\$134.99

- For controlling the cable tension when over-raising your plow system.
- Prevents winch, plow push frame and vehicle damage.
- Sensor retracted for optimal lift height.

## Plow Roller Fairlead

Defender, Defender MAX

715001223

\$81.99



- Cylindrical roller fairlead
- Larger diameter lower roller reduces wear on wire rope for plow application.
- Can be used with all ProMount plows.

## Super-Duty Plow System

### Super-Duty 72" (183 cm) Blade Plow Kits

Defender, Defender MAX

715003416

\$1,794.97



- A comprehensive plow system with manual lift and angling.
  - Ultra-durable 72" (183 cm) blade made of 12-gauge steel with integrated reinforcement and heavy-duty push tubes to tackle the most demanding jobs.
  - Requires a winch for raising and lowering.
  - Convenient disconnect system for quick and easy installation or removal.
  - Front mount provides minimum 11" (28 cm) lift distance.
- This kit includes:
- 72" (183 cm) SuperDuty Plow.
  - SuperDuty Plow Push Frame.
  - SuperDuty Plow Mounting Kit.

### Super-Duty Plow Hydraulic Angling Kit

Defender, Defender MAX (2019 & prior)

715002840

Defender, Defender MAX (2020 & up)

715006038

\$1,559.99



- Allows you to have full up/down and left/right plow control at your fingertips.
- Pre-assembled, comes with everything you need to turn your SuperDuty Plow into a quick, easy-to-control unit from the driver's seat.
- Using one hand to control all plow motions with the supplied joystick will allow you to easily concentrate and manage your plowing tasks.
- With this commercial grade kit, you will send snow exactly where you want reliably all winter long.
- Winch and plow sold separately.

### Super-Duty Plow Push Frame Extension

(Not illustrated)

SuperDuty Plow

715001221

\$359.99

- Extension to use the SuperDuty Plow with the Apache 360 LT Track System.
- Comes with Plow Magnetic Switch and Plow Pulley.
- Requires Front Bumper or Front Accessory Bar for installation.

### Plow Blade Extensions

SuperDuty Plow

715001217

\$329.99



- Side extensions for widening your plow blade by 6" (15 cm) on each side.
- Include rubber flaps for extension parts.
- Sold in pairs.

### Plow Edge Markers

(Not illustrated)

SuperDuty Plow

715001216

\$46.99

- For a more accurate view of the width of your plow.
- Allows you to work closely around objects.

### Plow Drift Cutter

(Not illustrated)

SuperDuty Plow

715001218

\$114.99

- Keeps snow securely in the plow.
- Allows you to cut a cleaner pass.
- Sold individually.

|   |                 |           |          |
|---|-----------------|-----------|----------|
| <b>Plow Rubber Flap</b><br><i>(Not illustrated)</i>   | Super-Duty Plow | 715001219 | \$114.99 |
| <ul style="list-style-type: none"> <li>Keeps snow away from the driver and helps snow to roll in front of the plow.</li> </ul>  |                 |           |          |
| <b>Plow Pulley</b><br><i>(Not illustrated)</i>  | Super-Duty Plow | 715002042 | \$54.99  |
| <ul style="list-style-type: none"> <li>For use with the Super-Duty Plow.</li> <li>Helps with churning efficiency.</li> <li>Requires Front XT Bumper.</li> </ul>         |                 |           |          |
| <b>Plow Magnetic Switch</b><br><i>(Not illustrated)</i>   | Super-Duty Plow | 715001995 | \$129.99 |
| <ul style="list-style-type: none"> <li>Magnetic switch that stops the winch to prevent cable, winch and frame damage.</li> <li>For use with Super-Duty Plow.</li> </ul> |                 |           |          |

# COVERS & ADD-ONS



|                      |                                      |           |          |
|----------------------|--------------------------------------|-----------|----------|
| <b>Trailer Cover</b> | Defender, Defender 6x6, Defender PRO | 715004453 | \$319.99 |
|                      | Defender MAX                         | 715004454 | \$509.99 |



- Heavy-duty canvas made of UV-resistant solution-dyed polyester.
- Inner soft liner protects windshield and colored panels from abrasion.
- All high-abrasion areas are reinforced with a double canvas layer.
- Weather-resistant trailer cover protects your vehicle during storage and transportation.
- Opening for fuel cap.
- Quick and easy installation.
- Designed to perfectly fit your vehicle with or without Can-Am accessories.
- Does not fit with Adventure Roof Rack (715003870).

|   |           |         |
|---|-----------|---------|
| <b>Bolt-On<sup>+</sup> Retractable Ratcheting Tie-Downs</b> | 295101072 | \$35.99 |
|---|-----------|---------|



- Perfect for transporting your power sport vehicle or securing loads.
- Mounts easily: Bolts on any flat surface (e.g., truck bed or frame).
- 1" x 6' (2.5 cm x 1.8 m) tie-down strap with heavy-duty stitching that delivers a 500 lb (226 kg) working load strength and 1,500 lb (680 kg) break strength.
- Convenient retractable push button automatically slackens, spools and stores away strap, while the ratchet mechanism tightens the strap snugly to secure your vehicle or load into place.
- Rubber ratcheting handle provides firm grip, and the hook is vinyl coated to protect whatever surface it hooks into.
- Sold in pairs.

|                          |                        |         |
|--------------------------|------------------------|---------|
| <b>Ratchet Tie-Downs</b> | 715008309 - Black/Gray | \$24.49 |
|--------------------------|------------------------|---------|



- 400 lb (181 kg) safe working load.
- 1" x 10' (2.5 cm x 3 m) strap with Sea-Doo, Ski-Doo and Can-Am logos.
- Deluxe ratchet with rubber handle.
- Coated S hooks.
- Pack of 2.

|                                    |           |         |
|------------------------------------|-----------|---------|
| <b>Heavy-Duty Ratchet Tie-Down</b> | 715008308 | \$44.99 |
|------------------------------------|-----------|---------|



- 1,000 lb (454 kg) safe working load.
- 1.5" x 6' (38 mm x 1.8 m) strap with BRP brands.
- Deluxe ratchet with rubber handle.
- Black-coated clip hooks.
- 12" (300 mm) webbing included.
- Pack of two.





---

# CAN-AM MAVERICK X3

---



# CAN-AM MAVERICK X3

CAN AM MAVERICK X3

## FEATURED PACKAGES

|   |    |
|---|----|
| 2024 M averick X3 D S Turbo                               | 72 |
| 2024 M averick X3 RS Turbo                                | 74 |
| 2024 M averick X3 M AX X rs Turbo RR<br>w ith Sm art-Shox | 76 |
| 2024 M averick X3 M AX X rc Turbo RR                      | 78 |

## COMPARATIVE CHART

### ACCESSORIES

|                                     |     |
|-------------------------------------|-----|
| Roofs                               | 87  |
| Soft Cab Enclosure                  | 88  |
| Windshields & Wind Protection       | 88  |
| Mirrors                             | 90  |
| Doors                               | 91  |
| Seat Accessories                    | 92  |
| HMWPE Skid Plates                   | 93  |
| Bumpers & Guards                    | 94  |
| LinQ :Easy On, Easy Off Cargo       | 97  |
| Racks & Storage                     | 101 |
| Lights                              | 103 |
| Audio & Communication Systems       | 107 |
| Electrical & Electronic Accessories | 108 |
| Winches & Hitches                   | 110 |
| Performance                         | 112 |
| Apache Track Systems                | 115 |
| ProMount P.lws                      | 117 |
| Cover & Trailering                  | 120 |







# 2024 MAVERICK X3 TURBO

---



\*Smart-Lok was developed in conjunction with TEAM industries, a market leader in the drive train industry. All other trademarks are the property of their respective owners.





 Firey Red & HyperSilver

## Feature highlights



### Grip It and Rip It

Smart-Lok™ is the most advanced off-road front differential. It's fully lockable on-the-fly, and its four automatic modes return the most grip possible in every condition when you ride the Can-Am Maverick X3 DS Turbo.



### Springing into Action

The unit packs the SHOWA HPG piggyback 2.5 spring for quick response as you explore further. With the dual-speed compression & dual-rate spring, every far-flung destination is suddenly within reach!



### Lending a Hand for Steering

The Can-Am Maverick X3 DS Turbo comes with high torque Dynamic Power Steering (DPS). The technology counteracts unstable or difficult steering caused by external forces like strong crosswinds or uneven roads. With DPS, you get proper steering assistance from the steering gear to never veer off path.



### Exploring to the Max!

The Can-Am Maverick X3 DS Turbo stands out on every escapade with 30 in. Maxxis Camore® tires with 14 in. cast-aluminum wheels. This setup guarantees your beast of a ride is ready to roam far and wide right out of the showroom.



### Trip Info at Your Fingertips

For riders, everything worth paying attention to is on the Can-Am Maverick X3 DS Turbo's 4.5 inch digital display. At that size, it's readable in all conditions and puts all the vehicle's information and controls at the tip of the driver's gloves.



### What's the Hook?

When towing is needed, rest assured the Can-Am Maverick X3 DS Turbo is ready. With a rear tow hook, there's a place to hook onto and to attach most straps.

# 2024 MAVERICK X3 RS TURBO

---



\*Smart-Lok was developed in conjunction with TEAM industries, a market leader in the drive train industry. All other trademarks are the property of their respective owners.





 Firey Red & HyperSilver

## Feature highlights



### Grip It and Rip It

Smart-Lok™ is the most advanced off-road front differential. It's fully lockable on-the-fly, and its four automatic modes return the most grip possible in every condition when you ride the Can-Am Maverick X3 RS Turbo.



### Springing into Action

The unit packs the SHOWA HPG piggyback 2.5 spring for quick response as you explore further. With the dual-speed compression & dual-rate spring, every far-flung destination is suddenly within reach!



### Lending a Hand for Steering

The Can-Am Maverick X3 RS Turbo comes with high torque Dynamic Power Steering (DPS). The technology counteracts unstable or difficult steering caused by external forces like strong crosswinds or uneven roads. With DPS, you get proper steering assistance from the steering gear to never veer off path.



### Exploring to the Max!

The Can-Am Maverick X3 RS Turbo stands out on every escapade with 30 in. Maxxis Camore® tires with 14 in. cast-aluminum wheels. This setup guarantees your beast of a ride is ready to roam far and wide right out of the showroom.



### Trip Info at Your Fingertips

For riders, everything worth paying attention to is on the Can-Am Maverick X3 RS Turbo's 4.5 inch digital display. At that size, it's readable in all conditions and puts all the vehicle's information and controls at the tip of the driver's gloves.





### What's the Hook?

When towing is needed, rest assured the Can-Am Maverick X3 RS Turbo is ready. With a rear tow hook, there's a place to hook onto and to attach most straps.

# 2024 MAVERICK X3 MAX X<sup>RS</sup> TURBO RR WITH SMART-FOX



-  Fiery Red & Hyper Silver
-  Triple Black
-  Dazzling Blue & Carbon Black

## PACKAGES

- Smart-Lok
- Smart-Fox
- FOX<sup>®</sup>
- Belt Protection System
- 8500 cc Turbo
- 7.6 in. Ground Clearance
- X-Protect
- 4-Point Seat Belts
- Can-Am
- 14 in. Wheel
- 32 in. Wheel
- Full ROPS
- HMV

\*Smart-Lok was developed in conjunction with TEAM industries, a market leader in the drive train industry.

\*\*Smart-Fox was developed in conjunction with FOX and Tractive Industries, a market leader in the suspension industry. All other trademarks are the property of their respective owners.



 Dazzling Blue & Carbon Black

## Feature highlights



### Grip It and Rip It

Smart-Lok™ is the most advanced off-road front differential. It's fully lockable on-the-fly, and its four automatic modes return maximum traction in every condition.



### Lightning Fast Suspension Response

Before Smart-Shox, customers had to choose between race-winning handling and a comfortable, all-day ride. Not anymore. Smart-Shox self-adjusts up to 200 times per second, boasting near-instantaneous response to rider inputs and terrain.



### A Ride That Handles More Power

Looking for power? The Can-Am Maverick X3 MAX X rs Turbo RR with Smart-Shox comes with a magneto output of 850 W! Whether it is to install high-performance lighting or Bluetooth™ accessories, the 850 W magneto can handle it.



### Keeping your Finger on the Belt

The Can-Am Maverick X3 MAX X rs Turbo RR with Smart-Shox comes with a belt monitoring system designed to ensure better longevity for your vehicle's belt. It works easily and intuitively; with an ambient display detailing the temperature of the belt, you can modify it as you need.



### Trip Info at Your Fingertips

Everything needed to control the perfect ride is on the Can-Am Maverick X3 MAX X rs Turbo RR with Smart-Shox 7.6 inch dash-mounted digital display with keypad. At that size, it's readable in all conditions and puts all the vehicle's information and controls at the ready.



### Harness Every Adventure

With 4-point harnesses awaiting every passenger, a fun and safe ride is around the corner. Standard shoulder pads and Ergo-Lok seats add to rider comfort and protection.



### Looking Like a Maverick

Ride with style in the Can-Am Maverick X3 MAX X rs Turbo RR with Smart-Shox, courtesy of the Can-Am LED Signature lights. With these on, you deliver a more aggressive and biting look and light up the way with bright and energy-efficient LEDs. Go chase the fun.



### Exploring to the Max!

The Can-Am Maverick X3 MAX X rs Turbo RR with Smart-Shox stands out thanks to its 32 in. Maxxis Camillo™ tires with 14 in. cast-aluminum beadlock wheels. Lock the tire bead in place mechanically and ride on knowing this setup is just about in possible to break loose during heavy acceleration or cornering.

# 2024 MAVERICK X3 MAXX<sub>RC</sub> TURBO RR

---



\*Smart-Lok was developed in conjunction with TEAM industries, a market leader in the drive train industry.  
All other trademarks are the property of their respective owners.





Hybrid White & Legion Red

## Feature highlights



### Grip It and Rip It

Smart-Lok™ is the most advanced off-road front differential. It's fully lockable on-the-fly, and its four automatic modes (2WD, 4WD with front differential locked, 4WD ROCK and 4WD TRAIL) return the most grip possible in every condition when you ride the Can-Am Maverick X3 MAX X rc Turbo RR.



### Bypass the Stress & Obstacles

You'll fall in love with the FOX® 3.0 PODIUM RC2® shocks with bypass on the Maverick X3 MAX X rc Turbo RR! Using the same race-proven damping technology as our trophy trucks, this technology turns your sidekick into the star of the show.



### Keeping Your Finger on the Belt

The Can-Am Maverick X3 MAX X rc Turbo RR comes with a belt monitoring system designed to ensure better longevity for your vehicle's belt. It works easily and intuitively: with an ambient display detailing the temperature of the belt, you can modify it as you need.



### Harness Every Adventure

With 4-point harnesses awaiting every passenger, a fun and safe ride is around the corner. Standard shoulder pads and Exgo-Lok seats add to rider comfort and protection.



### Exploring to the Max!

The Can-Am Maverick X3 MAX X rc Turbo RR stands out thanks to its 32-inch Maxxis Liberty tires with 15-inch cast-aluminum beadlock wheels. Lock the tire bead in place mechanically and ride on knowing this setup is just about impossible to break loose during heavy acceleration or cornering. These tires make sure your ride is ready to roam and at ease whether you're dune or desert riding.



### Barring Any Intrusion

Just about everywhere you look in the Maverick X3 MAX X rc Turbo RR, you see extra protection. Because we know riding can get rocky, the front bumper, halfdoors, full roof and intrusion bar on this model keep you safe. Whether it's protection from the weather or clearing obstacles away, this sidekick has it covered.



### Ready to Rock

The Can-Am Maverick X3 MAX X rc Turbo RR comes equipped with a 4,500-lb (2,041 kg) winch with synthetic rope. You can engage it with only the flick of a switch to dominate the most rocky terrain you come across. This feature is effective for vehicle recovery and pushing further on every adventure.







### Protection Wherever You Go

This model sports a High Molecular Weight Polyethylene (HMWPE) differential, under bumper skid plates, and a HMWPE front and rear suspension arm, as well as HMWPE rock sliders for full protection under the unit. No matter the terrain or weather, you can keep riding and chasing fun knowing that the Maverick X3 MAX X rc Turbo RR will glide smoothly over obstacles of all sizes.

| MAVERICK X3           |                              | DS TURBO***   | RS TURBO***   | DS TURBO RR***  | RS TURBO RR***  |
|-----------------------|------------------------------|---|---|---|---|
|                       |                              |    |    |   |    |
| COLOR OPTIONS         |                              | Finey Red & HyperSilver Catalyst Gray   | Finey Red & HyperSilver Catalyst Gray   | Finey Red & HyperSilver Catalyst Gray   | Finey Red & HyperSilver Catalyst Gray   |
| ENGINES               | Type                         | 135 hp, Rotax® ACE Advanced Combustion Efficiency 900 cc turbocharged triple-cylinder engine, liquid-cooled and high-performance air filter | 135 hp, Rotax® ACE Advanced Combustion Efficiency 900 cc turbocharged triple-cylinder engine, liquid-cooled and high-performance air filter | 200 hp, Rotax® ACE Advanced Combustion Efficiency 900 cc turbocharged triple-cylinder engine, liquid-cooled with integrated intercooler and high-performance air filter | 200 hp, Rotax® ACE Advanced Combustion Efficiency 900 cc turbocharged triple-cylinder engine, liquid-cooled with integrated intercooler and high-performance air filter |
|                       | Fuel Delivery System         | Intelligent Throttle Control (ITC™) with Electronic Fuel Injection (EFI)  | Intelligent Throttle Control (ITC™) with Electronic Fuel Injection (EFI)  | Intelligent Throttle Control (ITC™) with Electronic Fuel Injection (EFI)  | Intelligent Throttle Control (ITC™) with Electronic Fuel Injection (EFI)  |
|                       | Transmission                 | 5-speed primary and Quick Response System X (QRS-X) CVT with high airflow, L/H/N/R/P  | 5-speed primary and Quick Response System X (QRS-X) CVT with high airflow, L/H/N/R/P  | 5-speed primary and Quick Response System X (QRS-X) CVT with high airflow, L/H/N/R/P  | 5-speed primary and Quick Response System X (QRS-X) CVT with high airflow, L/H/N/R/P  |
|                       | Drive Train                  | Lockable front differential with exclusive Sm art-Lok™ True 2W D / 4W D with front diff lock / 4W D TRAIL ACTV / 4W D TRAIL                 | Lockable front differential with exclusive Sm art-Lok™ True 2W D / 4W D with front diff lock / 4W D TRAIL ACTV / 4W D TRAIL                 | Lockable front differential with exclusive Sm art-Lok™ True 2W D / 4W D with front diff lock / 4W D TRAIL ACTV / 4W D TRAIL   | Lockable front differential with exclusive Sm art-Lok™ True 2W D / 4W D with front diff lock / 4W D TRAIL ACTV / 4W D TRAIL   |
|                       | Power Steering               | High-torque TRIM mode Dynamic Power Steering (DPS™)   | High-torque TRIM mode Dynamic Power Steering (DPS™)   | High-torque TRIM mode Dynamic Power Steering (DPS™)   | High-torque TRIM mode Dynamic Power Steering (DPS™)   |
| SUSPENSIONS           | Front Suspension             | Double A-arm with sway bar / 20 in. (50.8 cm) suspension travel   | Double A-arm with sway bar / 20 in. (50.8 cm) suspension travel   | Double A-arm with sway bar / 20 in. (50.8 cm) suspension travel   | Double A-arm with sway bar / 22 in. (55.9 cm) suspension travel Trophy truck inspired arms  |
|                       | Front Shocks                 | SHOW A HPG P iggyback 2.5 (dual-speed compression, dual-rate spring)  | SHOW A HPG P iggyback 2.5 (dual-speed compression, dual-rate spring)  | SHOW A HPG P iggyback 2.5 (dual-speed compression, dual-rate spring)  | SHOW A HPG P iggyback 2.5 (dual-speed compression, dual-rate spring)  |
|                       | Rear Suspension              | 4-link Torsional Trailing Arm X (TX) with sway bar / 20 in. (50.8 cm) suspension travel   | 4-link Torsional Trailing Arm X (TX) with sway bar / 22 in. (55.9 cm) suspension travel   | 4-link Torsional Trailing Arm X (TX) with sway bar / 20 in. (50.8 cm) suspension travel   | 4-link Torsional Trailing Arm X (TX) with sway bar / 22 in. (55.9 cm) suspension travel   |
|                       | Rear Shocks                  | SHOW A HPG P iggyback 2.5 (dual-speed compression, dual-rate spring)  | SHOW A HPG P iggyback 2.5 (dual-speed compression, dual-rate spring)  | SHOW A HPG P iggyback 2.5 (dual-speed compression, dual-rate spring)  | SHOW A HPG P iggyback 2.5 (dual-speed compression, dual-rate spring)  |
| TIRES & WHEELS        | Front / Rear Tires<br>Wheels | M axxis Camkomer® 30 x 10 x 14 in. 14 in. cast aluminum   | M axxis Camkomer® 30 x 10 x 14 in. 14 in. cast aluminum   | M axxis Camkomer® 30 x 10 x 14 in. 14 in. cast aluminum   | M axxis Camkomer® 30 x 10 x 14 in. 14 in. cast aluminum   |
| BRAKES                | Front                        | Dual 262 mm disc brakes with hydraulic twin-piston calipers   | Dual 262 mm disc brakes with hydraulic twin-piston calipers   | Dual 262 mm disc brakes with hydraulic twin-piston calipers   | Dual 262 mm disc brakes with hydraulic twin-piston calipers   |
|                       | Rear                         | Dual 248 mm disc brakes with hydraulic twin-piston calipers   | Dual 248 mm disc brakes with hydraulic twin-piston calipers   | Dual 248 mm disc brakes with hydraulic twin-piston calipers   | Dual 248 mm disc brakes with hydraulic twin-piston calipers   |
| DIMENSIONS CAPACITIES | Estimated Dry Weight         | 1,546 lb (701.3 kg)   | 1,673 lb (758.9 kg)   | 1,546 lb (701.3 kg)   | 1,673 lb (758.9 kg)   |
|                       | Chassis / Cage               | Dual phase 980 steel  | Dual phase 980 steel  | Dual phase 980 steel  | Dual phase 980 steel  |
|                       | L x W x H                    | 132 x 64 x 65.4 in. (335.3 x 162.5 x 166.1 cm)  | 132 x 72.4 x 68.5 in. (335.3 x 183.9 x 174 cm)  | 132 x 64 x 65.4 in. (335.3 x 162.5 x 166.1 cm)  | 132 x 72.4 x 68.5 in. (335.3 x 183.9 x 174 cm)  |
|                       | Wheelbase                    | 102 in. (259.1 cm)  | 102 in. (259.1 cm)  | 102 in. (259.1 cm)  | 102 in. (259.1 cm)  |
|                       | Ground Clearance             | 14 in. (35.6 cm)  | 16 in. (40.6 cm)  | 14 in. (35.6 cm)  | 16 in. (40.6 cm)  |
|                       | Rack Capacity                | 200 lb (91 kg) with LinQ® quick-attach  | 200 lb (91 kg) with LinQ® quick-attach  | 200 lb (91 kg) with LinQ® quick-attach  | 200 lb (91 kg) with LinQ® quick-attach  |
|                       | Storage Capacity             | Total: 2.5 gal (9.4 L)  | Total: 2.5 gal (9.4 L)  | Total: 2.5 gal (9.4 L)  | Total: 2.5 gal (9.4 L)  |
|                       | Fuel Capacity                | 10.5 gal (40 L)   | 10.5 gal (40 L)   | 10.5 gal (40 L)   | 10.5 gal (40 L)   |
| FEATURES              | Gauge                        | 4.5 in. wide digital display with keypad  | 4.5 in. wide digital display with keypad  | 4.5 in. wide digital display with keypad  | 4.5 in. wide digital display with keypad  |
|                       | Instrumentation              | DC outlet (10 A)  | DC outlet (10 A)  | DC outlet (10 A)  | DC outlet (10 A)  |
|                       | Anti-Theft System            | RFD digitally Encoded Security System (DESS™) with start/stop button  | RFD digitally Encoded Security System (DESS™) with start/stop button  | RFD digitally Encoded Security System (DESS™) with start/stop button  | RFD digitally Encoded Security System (DESS™) with start/stop button  |
|                       | Lighting                     | LED headlight<br>LED taillights   | LED headlight<br>LED taillights   | LED headlight<br>LED taillights   | LED headlight<br>LED taillights   |
|                       | Winch                        | N/A   | N/A   | N/A   | N/A   |
|                       | Magneto                      | 650 W   | 650 W   | 850 W   | 850 W   |
|                       | Protection                   | Integrated front bumper per Quarter-doors<br>HM W PE full skid plate<br>Rear tow hook   | Integrated front bumper per Quarter-doors<br>HM W PE full skid plate<br>Rear tow hook   | Integrated front bumper per Quarter-doors<br>HM W PE full skid plate<br>Rear tow hook   | Integrated front bumper per Quarter-doors<br>HM W PE full skid plate<br>Rear tow hook   |

\*Sm art-Lok was developed in conjunction with TEAM Industries, a market leader in the drive train industry.  
 \*\*Sm art-Shox was developed in conjunction with Tractec Industries, a market leader in the suspension industry.  
 \*\*\*6-month BRP limited warranty. BEST term available up to 30 months.

| MAVERICK X3           |   | X ds TURBO RR***  | X3 X rs TURBO RR***   | X rs TURBO RR with Smart-Shox** ***   | X rc TURBO RR 64****  |
|-----------------------|---|---|---|---|---|
|                       |   |    |    |   |    |
| COLOR OPTIONS         |   | Fiszy Red & HyperSilver Triple Black  | Fiszy Red & HyperSilver Triple Black<br>Dazzling Blue & Carbon Black  | Fiszy Red & HyperSilver Triple Black<br>Dazzling Blue & Carbon Black  | Hybrid White & Legion Red   |
| ENGINES               | Type  | 200 hp, Rotax® ACE Advanced Combustion Efficiency 900 cc turbocharged triple-cylinder engine, liquid-cooled with integrated intercooler and high-performance air filter | 200 hp, Rotax® ACE Advanced Combustion Efficiency 900 cc turbocharged triple-cylinder engine, liquid-cooled with integrated intercooler and high-performance air filter | 200 hp, Rotax® ACE Advanced Combustion Efficiency 900 cc turbocharged triple-cylinder engine, liquid-cooled with integrated intercooler and high-performance air filter | 200 hp, Rotax® ACE Advanced Combustion Efficiency 900 cc turbocharged triple-cylinder engine, liquid-cooled with integrated intercooler and high-performance air filter   |
|                       | Fuel Delivery System  | Intelligent Throttle Control (ITC™) with Electronic Fuel Injection (EFI)  | Intelligent Throttle Control (ITC™) with Electronic Fuel Injection (EFI)  | Intelligent Throttle Control (ITC™) with Electronic Fuel Injection (EFI)  | Intelligent Throttle Control (ITC™) with Electronic Fuel Injection (EFI)  |
|                       | Transmission  | 5-speed primary and Quick Response System X (QRS-X) CVT with high airflow, L/H/N/R/P  | 5-speed primary and Quick Response System X (QRS-X) CVT with high airflow, L/H/N/R/P  | 5-speed primary and Quick Response System X (QRS-X) CVT with high airflow, L/H/N/R/P  | 5-speed primary and Quick Response System X (QRS-X) CVT with high airflow, L/H/N/R/P  |
|                       | Drive Train   | Lockable front differential with exclusive Smart-Lok™ True 2W D / 4W D with front diff lock / 4W D TRAIL ACT™ / 4W D TRAIL  | Lockable front differential with exclusive Smart-Lok™ True 2W D / 4W D with front diff lock / 4W D TRAIL ACT™ / 4W D TRAIL  | Lockable front differential with exclusive Smart-Lok™ True 2W D / 4W D with front diff lock / 4W D TRAIL ACT™ / 4W D TRAIL  | Lockable front differential with exclusive Smart-Lok™ True 2W D / 4W D with front diff lock / 4W D TRAIL ACT™ / 4W D TRAIL  |
|                       | Power Steering  | High-torque Trimode Dynamic Power Steering (DPS™)   | High-torque Trimode Dynamic Power Steering (DPS™)   | High-torque Trimode Dynamic Power Steering (DPS™)   | High-torque Trimode Dynamic Power Steering (DPS™)   |
| SUSPENSIONS           | Front Suspension  | Double A-arm with swaybar / 20 in. 60.8 cm suspension travel  | Double A-arm with swaybar / 22 in. 65.9 cm suspension travel<br>Trophy truck inspired arms  | Double A-arm with swaybar / 22 in. 65.9 cm suspension travel  | Double arched A-arm with swaybar / 20 in. 60.8 cm suspension travel   |
|                       | Front Shocks  | FOX® 2.5 PODIUM RC2™ Piggyback with dual-speed compression and rebound adjustments  | FOX® 2.5 PODIUM RC2™ Piggyback with bypass, dual-speed compression and rebound adjustments  | FOX® 2.5 PODIUM™ Piggyback with bypass and Smart-Shox™ Technology featuring DDA Valve Dynamic Damping Adjustment  | FOX® 2.5 PODIUM Piggyback with QSS™ compression adjustment  |
|                       | Rear Suspension   | 4-link Torsional Trailing Arm X (TTX) with swaybar / 20 in. 60.8 cm suspension travel   | 4-link Torsional Trailing Arm X (TTX) with swaybar / 24 in. 61 cm suspension travel   | 4-link Torsional Trailing Arm X (TTX) with swaybar / 24 in. 61 cm suspension travel   | 4-link Torsional Trailing Arm X (TTX) with swaybar and arched lower links / 20 in. 60.8 cm suspension travel  |
|                       | Rear Shocks   | FOX® 2.5 PODIUM RC2™ Piggyback with dual-speed compression, rebound adjustments and bottom-out control  | FOX® 3.0 PODIUM RC2™ remote reservoir with bypass, dual-speed compression and rebound adjustments   | FOX® 3.0 PODIUM™ remote reservoir with bypass and Smart-Shox™ Technology featuring DDA Valve Dynamic Damping Adjustment   | FOX® 2.5 PODIUM Piggyback with QSS™ compression adjustment and bottom-out control   |
| TIRES & WHEELS        | Maxxis Camdrome® 30 x 10 x 14 in. 14 in. cast-alum rim beadlock | Maxxis Camdrome® 32 x 10 x 14 in. 14 in. cast-alum rim beadlock   | Maxxis Camdrome® 32 x 10 x 14 in. 14 in. cast-alum rim beadlock   | Maxxis Liberty® 30 x 10 x 14 in. 14 in. cast-alum rim   |   |
| BRAKES                | Front   | Dual 262 mm disc brakes with hydraulic twin-piston calipers   | Dual 262 mm disc brakes with hydraulic twin-piston calipers   | Dual 262 mm disc brakes with hydraulic twin-piston calipers   | Dual 262 mm disc brakes with hydraulic twin-piston calipers   |
|                       | Rear  | Dual 248 mm disc brakes with hydraulic twin-piston calipers   | Dual 248 mm disc brakes with hydraulic twin-piston calipers   | Dual 248 mm disc brakes with hydraulic twin-piston calipers   | Dual 248 mm disc brakes with hydraulic twin-piston calipers   |
| DIMENSIONS CAPACITIES | Estimated Dry Weight  | 1,554 lb (704.9 kg)   | 1,680 lb (762 kg)   | 1,699 lb (770.7 kg)   | 1,674 lb (759.3 kg)   |
|                       | Chassis / Cage  | Dualphase 980 steel   | Dualphase 980 steel   | Dualphase 980 steel   | Dualphase 980 steel   |
|                       | L x W x H   | 132 x 64 x 65.7 in. 635.3 x 162.5 x 166.9 cm  | 132 x 72.7 x 68.5 in. 635.3 x 184.7 x 174 cm  | 132 x 72.7 x 68.5 in. 635.3 x 184.7 x 174 cm  | 133 x 65.6 x 66 in. 637.8 x 166.6 x 167.6 cm  |
|                       | Wheelbase   | 102 in. 259.1 cm  | 102 in. 259.1 cm  | 102 in. 259.1 cm  | 102 in. 259.1 cm  |
|                       | Ground Clearance  | 14 in. 65.6 cm  | 16 in. 40.6 cm  | 16 in. 40.6 cm  | 14 in. 65.6 cm  |
|                       | Rack Capacity   | 200 lb (91 kg) with LhQ® quick-attach   | 200 lb (91 kg) with LhQ® quick-attach   | 200 lb (91 kg) with LhQ® quick-attach   | 200 lb (91 kg) with LhQ® quick-attach   |
|                       | Storage Capacity  | Total: 2.5 gal (9.4 L)  | Total: 2.5 gal (9.4 L)  | Total: 2.5 gal (9.4 L)  | Total: 2.5 gal (9.4 L)  |
|                       | Fuel Capacity   | 10.5 gal (40 L)   | 10.5 gal (40 L)   | 10.5 gal (40 L)   | 10.5 gal (40 L)   |
| FEATURES              | Gauge   | 7.6 in. wide digital display with keypad  | 7.6 in. wide digital display with keypad  | 7.6 in. wide digital display with keypad  | 7.6 in. wide digital display with keypad  |
|                       | Instrumentation   | DC outlet (10 A)  | DC outlet (10 A)  | DC outlet (10 A)  | DC outlet (10 A)  |
|                       | Anti-Theft System   | RF Dually Encoded Security System (DESS™) with start/stop button  | RF Dually Encoded Security System (DESS™) with start/stop button  | RF Dually Encoded Security System (DESS™) with start/stop button  | RF Dually Encoded Security System (DESS™) with start/stop button  |
|                       | Lighting  | LED headlight<br>LED signature<br>LED taillights  | LED headlight<br>LED signature<br>LED taillights  | LED headlight<br>LED signature<br>LED taillights  | LED headlight<br>LED signature<br>LED taillights  |
|                       | Winch   | N/A   | N/A   | N/A   | 4,500 lb (2,041 kg) winch with synthetic rope   |
|                       | Magneto   | 850 W   | 850 W   | 850 W   | 850 W   |
|                       | Protection  | Integrated frontbumper<br>Quarterdoors<br>Fullroof<br>4-point harness with shoulder pads<br>HMW PE fillskid plate<br>Rear tow hook                                      | Integrated frontbumper<br>Quarterdoors<br>Fullroof<br>4-point harness with shoulder pads<br>HMW PE fillskid plate<br>Rear tow hook                                      | Integrated frontbumper<br>Quarterdoors<br>Fullroof<br>4-point harness with shoulder pads<br>HMW PE fillskid plate<br>Rear tow hook                                      | Frontbumper<br>Quarterdoors<br>HMW PE rock sliders<br>HMW PE skid plates<br>Fullheavy-duty differential/underbumper per front and rear suspension arm<br>Rear tow hook<br>Trailing Arm protector<br>Lower A-arm protector |

\*Smart-Lok was developed in conjunction with the TEAM Industries, a market leader in the drive train industry.

\*\*Smart-Shox was developed in conjunction with the Tractive Industries, a market leader in the suspension industry.

\*\*\*6-month BRP limited warranty. B.E.S.T. team available up to 30 months.

| MAVERICK X3             |  | X rc TURBO RR 72"***   | X mr TURBO RR 64"***  | X mr TURBO RR 72"***  | MAX DS TURBO ***  |
|-------------------------|--|--|---|---|---|
|                         |  |   |    |   |    |
| COLOR OPTIONS           |  | Hybrid White & Legion Red  | Hybrid White & Legion Red   | Hybrid White & Legion Red   | Fairy Red & HyperSilver Catalyst Gray   |
| ENGINES                 | Type   | 200 hp, Rotax® ACE Advanced Combustion Efficiency 900 cc turbocharged triple-cylinder engine, liquid-cooled with integrated intercooler and high-performance air filter  | 200 hp, Rotax® ACE Advanced Combustion Efficiency 900 cc turbocharged triple-cylinder engine, liquid-cooled with integrated intercooler, high-performance air filter and strategically positioned engine air intake | 200 hp, Rotax® ACE Advanced Combustion Efficiency 900 cc turbocharged triple-cylinder engine, liquid-cooled with integrated intercooler, high-performance air filter and strategically positioned engine air intake | 135 hp, Rotax® ACE Advanced Combustion Efficiency 900 cc turbocharged triple-cylinder engine, liquid-cooled and high-performance air filter |
|                         | Fuel Delivery System   | Intelligent Throttle Control (ITC™) with Electronic Fuel Injection (EFI)   | Intelligent Throttle Control (ITC™) with Electronic Fuel Injection (EFI)  | Intelligent Throttle Control (ITC™) with Electronic Fuel Injection (EFI)  | Intelligent Throttle Control (ITC™) with Electronic Fuel Injection (EFI)  |
|                         | Transmission   | 6-speed primary and Quick Response System X (QRS-X) CVT with high airflow, L/H/N/R/P   | 6-speed primary and Quick Response System X (QRS-X) CVT, high airflow with strategically positioned CVT air intake and exhaust, L/H/N/R/P   | 6-speed primary and Quick Response System X (QRS-X) CVT, high airflow with strategically positioned CVT air intake and exhaust, L/H/N/R/P   | 6-speed primary and Quick Response System X (QRS-X) CVT with high airflow, L/H/N/R/P  |
|                         | Drive Train  | Lockable front differential with exclusive Smart-Lok* technology. True 4 m odes traction system :2W D / 4W D with front diff lock / 4W D ROCK / 4W D TRAIL   | Lockable front differential with exclusive Smart-Lok* technology. True 4 m odes traction system :2W D / 4W D with front diff lock / 4W D MUD / 4W D TRAIL   | Lockable front differential with exclusive Smart-Lok* technology. True 4 m odes traction system :2W D / 4W D with front diff lock / 4W D MUD / 4W D TRAIL   | Lockable front differential with exclusive Smart-Lok* technology. True 2W D / 4W D with front diff lock / 4W D TRAIL ACTIV / 4W D TRAIL     |
|                         | Power Steering   | High-torque Tridem Dynamic Power Steering (DPS™)   | High-torque Tridem Dynamic Power Steering (DPS™)  | High-torque Tridem Dynamic Power Steering (DPS™)  | High-torque Tridem Dynamic Power Steering (DPS™)  |
| SUSPENSIONS             | Front Suspension   | Trophy truck inspired double arched A-arm with sway bar / 22 in. (55.9 cm) suspension travel   | Double arched A-arm with sway bar / 20 in. (50.8 cm) suspension travel  | Double arched A-arm with sway bar / 22 in. (55.9 cm) suspension travel  | Double A-arm with sway bar / 20 in. (50.8 cm) suspension travel   |
|                         | Front Shocks   | FOX® 2.5 PODIUM RC2™ Piggyback with bypass, dual-speed compression and rebound adjustments   | FOX® 2.5 PODIUM Piggyback with QS3™ compression adjustment  | FOX® 2.5 PODIUM Piggyback with QS3™ compression adjustment  | SHOWA HPG Piggyback 2.5 (dual-speed compression, dual-rate spring)  |
|                         | Rear Suspension  | 4-link Torsional Trailing Arm X (TTX) with sway bar and arched lower links / 24 in. (61 cm) suspension travel  | 4-link Torsional Trailing Arm X (TTX) with sway bar and arched lower links / 20 in. (50.8 cm) suspension travel   | 4-link Torsional Trailing Arm X (TTX) with sway bar and arched lower links / 22 in. (55.9 cm) suspension travel   | 4-link Torsional Trailing Arm X (TTX) with sway bar / 20 in. (50.8 cm) suspension travel  |
|                         | Rear Shocks  | FOX® 3.0 PODIUM RC2™ remote reservoir with bypass, dual-speed compression and rebound adjustments  | FOX® 2.5 PODIUM Piggyback with QS3™ compression adjustment and bottom-out control   | FOX® 2.5 PODIUM Piggyback with QS3™ compression adjustment and bottom-out control   | SHOWA HPG Piggyback 2.5 (dual-speed compression, dual-rate spring)  |
| TIRES & WHEELS          | Front / Rear Tires<br>Maxxis Liberty® 32 x 10 x 15 in. 15 in. cast-aluminum beadlock | Front / Rear Tires<br>ITP Cryptid 30 x 9 / 11 x 14 in. 14 in. cast-aluminum with machined finish   | Front / Rear Tires<br>ITP Cryptid 30 x 9 / 11 x 14 in. 14 in. cast-aluminum beadlock  | Front / Rear Tires<br>Maxxis Comanche® 30 x 10 x 14 in. 14 in. cast-aluminum  |   |
| BRAKES                  | Front  | Dual 262 mm disc brakes with hydraulic twin-piston calipers  | Dual 262 mm disc brakes with hydraulic twin-piston calipers   | Dual 262 mm disc brakes with hydraulic twin-piston calipers   | Dual 262 mm disc brakes with hydraulic twin-piston calipers   |
|                         | Rear   | Dual 248 mm disc brakes with hydraulic twin-piston calipers  | Dual 248 mm disc brakes with hydraulic twin-piston calipers   | Dual 248 mm disc brakes with hydraulic twin-piston calipers   | Dual 248 mm disc brakes with hydraulic twin-piston calipers   |
| DIMENSIONS / CAPACITIES | Estimated Dry Weight   | 1,843 lb (836 kg)  | 1,705 lb (773 kg)   | 1,758 lb (797 kg)   | 1,810 lb (821 kg)   |
|                         | Chassis / Cage   | Dual-phase 980 steel   | Dual-phase 980 steel  | Dual-phase 980 steel  | Dual-phase 980 steel  |
|                         | L x W x H  | 134.5 x 72.8 x 68.5 in. (341.6 x 184.9 x 174 cm)   | 133 x 66.7 x 66.1 in. (337.8 x 169.4 x 167.9 cm)  | 132.3 x 74.2 x 68 in. (336 x 188.5 x 172.7 cm)  | 164 x 64 x 65.8 in. (416.6 x 162.5 x 167.1 cm)  |
|                         | Wheelbase  | 102 in. (259.1 cm)   | 102 in. (259.1 cm)  | 102 in. (259.1 cm)  | 135 in. (342.9 cm)  |
|                         | Ground Clearance   | 16 in. (40.6 cm)   | 14 in. (35.6 cm)  | 16 in. (40.6 cm)  | 13 in. (33 cm)  |
|                         | Rack Capacity  | 200 lb (91 kg) with LinQ® quick-attach   | 200 lb (91 kg) with LinQ® quick-attach  | 200 lb (91 kg) with LinQ® quick-attach  | 150 lb (68 kg) with LinQ® quick-attach  |
|                         | Storage Capacity   | Total: 2.5 gal (9.4 L)   | Total: 2.5 gal (9.4 L)  | Total: 2.5 gal (9.4 L)  | Total: 3 gal (11.4 L)   |
|                         | Fuel Capacity  | 10.5 gal (40 L)  | 10.5 gal (40 L)   | 10.5 gal (40 L)   | 10.5 gal (40 L)   |
| FEATURES                | Gauge  | 7.5 in. wide digital display with keypad   | 7.5 in. wide digital display with keypad  | 7.5 in. wide digital display with keypad  | 4.5 in. wide digital display with keypad  |
|                         | Instrumentation  | DC outlet (10 A)   | DC outlet (10 A)  | DC outlet (10 A)  | DC outlet (10 A)  |
|                         | Anti-Theft System  | RFD digitally Encoded Security System (DESS™) with start/stop button   | RFD digitally Encoded Security System (DESS™) with start/stop button  | RFD digitally Encoded Security System (DESS™) with start/stop button  | RFD digitally Encoded Security System (DESS™) with start/stop button  |
|                         | Lighting   | LED headlight<br>LED signature<br>LED taillights   | LED headlight<br>LED signature<br>LED taillights  | LED headlight<br>LED signature<br>LED taillights  | LED headlight<br>LED taillights   |
|                         | Winch  | 4,500 lb (2,041 kg) winch with synthetic rope  | 4,500 lb (2,041 kg) winch with synthetic rope   | 4,500 lb (2,041 kg) winch with synthetic rope   | N/A   |
|                         | Magneto  | 850 W  | 850 W   | 850 W   | 650 W   |
|                         | Protection   | Frontbumper<br>Halfdoors<br>Fullroof<br>Intrusion bar<br>4-point harness with shoulder pads<br>UHMWPE mock sliders<br>HMWPE skid plates<br>Full heavy-duty with differential/underbumper per / front and rear suspension arm<br>Rear tow hook<br>Trailing Arm protector<br>Lower A-arm protector | Frontbumper<br>Halfdoors<br>Front and rear tow hooks<br>HMWPE full skid plate   | Frontbumper<br>Halfdoors<br>Front and rear tow hooks<br>HMWPE full skid plate   | Integrated frontbumper<br>Quarterdoors<br>HMWPE full skid plate<br>Rear tow hook  |

\*Smart-Lok was developed in conjunction with TEAM Industries, a market leader in the drive train industry.  
\*\*Smart-Shox was developed in conjunction with Tractec Industries, a market leader in the suspension industry.  
\*\*\*6-month BRP limited warranty. BEST term available up to 30 months.







| MAVERICK X3           |                              | MAX RS TURBO***   | MAX DS TURBO RR***  | MAX RS TURBO RR***  | MAX X ds TURBO RR***  |
|-----------------------|------------------------------|---|---|---|---|
|                       |                              |    |    |   |    |
| COLOR OPTIONS         |                              | FiazRed & HyperSilver Catalyst Gray   | FiazRed & HyperSilver Catalyst Gray   | FiazRed & HyperSilver Catalyst Gray   | FiazRed & HyperSilver Triple Black  |
| ENGINES               | Type                         | 135 hp, Rotax® ACE Advanced Combustion Efficiency 900 cc turbocharged triple-cylinder engine, liquid-cooled and high-performance air filter | 200 hp, Rotax® ACE Advanced Combustion Efficiency 900 cc turbocharged triple-cylinder engine, liquid-cooled with integrated intercooler and high-performance air filter | 200 hp, Rotax® ACE Advanced Combustion Efficiency 900 cc turbocharged triple-cylinder engine, liquid-cooled with integrated intercooler and high-performance air filter | 200 hp, Rotax® ACE Advanced Combustion Efficiency 900 cc turbocharged triple-cylinder engine, liquid-cooled with integrated intercooler and high-performance air filter |
|                       | Fuel Delivery System         | Intelligent Throttle Control (ITC™) with Electronic Fuel Injection (EFI)  | Intelligent Throttle Control (ITC™) with Electronic Fuel Injection (EFI)  | Intelligent Throttle Control (ITC™) with Electronic Fuel Injection (EFI)  | Intelligent Throttle Control (ITC™) with Electronic Fuel Injection (EFI)  |
|                       | Transmission                 | 6-Speed Prerail and Quick Response System X (QRS-X) CVT with high airflow, L/H/N/R/P  | 6-Speed Prerail and Quick Response System X (QRS-X) CVT with high airflow, L/H/N/R/P  | 6-Speed Prerail and Quick Response System X (QRS-X) CVT with high airflow, L/H/N/R/P  | 6-Speed Prerail and Quick Response System X (QRS-X) CVT with high airflow, L/H/N/R/P  |
|                       | Drive Train                  | Lockable front differential with exclusive Sm art-Lok™ True 2W D / 4W D with front differential lock / 4W D TRAIL ACT™ / 4W D TRAIL         | Lockable front differential with exclusive Sm art-Lok™ True 2W D / 4W D with front differential lock / 4W D TRAIL ACT™ / 4W D TRAIL                                     | Lockable front differential with exclusive Sm art-Lok™ True 2W D / 4W D with front differential lock / 4W D TRAIL ACT™ / 4W D TRAIL                                     | Lockable front differential with exclusive Sm art-Lok™ True 2W D / 4W D with front differential lock / 4W D TRAIL ACT™ / 4W D TRAIL                                     |
|                       | Power Steering               | High-torque Trimode Dynamic Power Steering (DPS™)   | High-torque Trimode Dynamic Power Steering (DPS™)   | High-torque Trimode Dynamic Power Steering (DPS™)   | High-torque Trimode Dynamic Power Steering (DPS™)   |
| SUSPENSIONS           | Front Suspension             | Double A-arm with sway bar / 22 in. (55.9 cm) suspension travel<br>Trophy truck inspired arms   | Double A-arm with sway bar / 20 in. (50.8 cm) suspension travel   | Double A-arm with sway bar / 22 in. (55.9 cm) suspension travel<br>Trophy truck inspired arms   | Double A-arm with sway bar / 20 in. (50.8 cm) suspension travel   |
|                       | Front Shocks                 | SHOW A HPG Piggyback 2.5 (dual-speed compression, dual-rate spring)   | SHOW A HPG Piggyback 2.5 (dual-speed compression, dual-rate spring)   | SHOW A HPG Piggyback 2.5 (dual-speed compression, dual-rate spring)   | FOX® 2.5 PODIUM RC2™ Piggyback with dual-speed compression and rebound adjustments  |
|                       | Rear Suspension              | 4-link Torsional Trailing Arm X (TTX) with sway bar / 22 in. (55.9 cm) suspension travel  | 4-link Torsional Trailing Arm X (TTX) with sway bar / 20 in. (50.8 cm) suspension travel  | 4-link Torsional Trailing Arm X (TTX) with sway bar / 22 in. (55.9 cm) suspension travel  | 4-link Torsional Trailing Arm X (TTX) with sway bar / 20 in. (50.8 cm) suspension travel  |
|                       | Rear Shocks                  | SHOW A HPG Piggyback 2.5 (dual-speed compression, dual-rate spring)   | SHOW A HPG Piggyback 2.5 (dual-speed compression, dual-rate spring)   | SHOW A HPG Piggyback 2.5 (dual-speed compression, dual-rate spring)   | FOX® 2.5 PODIUM RC2™ Piggyback with dual-speed compression, rebound adjustments and bottom-out control  |
| TIRES & WHEELS        | Front / Rear Tires<br>Wheels | M axxis CamHorn® 30 x 10 x 14 in. 14 in. cast-alum rim  | M axxis CamHorn® 30 x 10 x 14 in. 14 in. cast-alum rim  | M axxis CamHorn® 30 x 10 x 14 in. 14 in. cast-alum rim  | M axxis CamHorn® 30 x 10 x 14 in. 14 in. cast-alum rim beadlock   |
| BRAKES                | Front                        | Dual 262 mm disc brakes with hydraulic twin-piston calipers   | Dual 262 mm disc brakes with hydraulic twin-piston calipers   | Dual 262 mm disc brakes with hydraulic twin-piston calipers   | Dual 262 mm disc brakes with hydraulic twin-piston calipers   |
|                       | Rear                         | Dual 248 mm disc brakes with hydraulic twin-piston calipers   | Dual 248 mm disc brakes with hydraulic twin-piston calipers   | Dual 248 mm disc brakes with hydraulic twin-piston calipers   | Dual 248 mm disc brakes with hydraulic twin-piston calipers   |
| DIMENSIONS CAPACITIES | Estimated Dry Weight         | 1,942 lb (880.9 kg)   | 1,810 lb (821 kg)   | 1,942 lb (880.9 kg)   | 1,838 lb (833.7 kg)   |
|                       | Chassis / Cage               | Dualphase 980 steel   | Dualphase 980 steel   | Dualphase 980 steel   | Dualphase 980 steel   |
|                       | L x W x H                    | 164 x 64 x 65.8 in. (416.6 x 162.5 x 167.1 cm)  | 164 x 64 x 65.8 in. (416.6 x 162.5 x 167.1 cm)  | 164 x 72.4 x 68.5 in. (416.6 x 183.9 x 174 cm)  | 164 x 64 x 66 in. (416.6 x 162.5 x 167.6 cm)  |
|                       | Wheelbase                    | 135 in. (342.9 cm)  | 135 in. (342.9 cm)  | 135 in. (342.9 cm)  | 135 in. (342.9 cm)  |
|                       | Ground Clearance             | 16 in. (40.6 cm)  | 13 in. (33 cm)  | 16 in. (40.6 cm)  | 13 in. (33 cm)  |
|                       | Rack Capacity                | 150 lb (68 kg) with LinQ® quick-attach  | 150 lb (68 kg) with LinQ® quick-attach  | 150 lb (68 kg) with LinQ® quick-attach  | 150 lb (68 kg) with LinQ® quick-attach  |
|                       | Storage Capacity             | Total: 3 gal (11.4 L)   | Total: 3 gal (11.4 L)   | Total: 3 gal (11.4 L)   | Total: 3 gal (11.4 L)   |
|                       | Fuel Capacity                | 10.5 gal (40 L)   | 10.5 gal (40 L)   | 10.5 gal (40 L)   | 10.5 gal (40 L)   |
|                       |                              |   |   |   |   |
| FEATURES              | Gauge                        | 4.5 in. wide digital display with keypad  | 4.5 in. wide digital display with keypad  | 4.5 in. wide digital display with keypad  | 7.5 in. wide digital display with keypad  |
|                       | Instrumentation              | DC outlet (10 A)  | DC outlet (10 A)  | DC outlet (10 A)  | DC outlet (10 A)  |
|                       | Anti-Theft System            | RF D igitally Encoded Security System (DESS™) with start/stop button  | RF D igitally Encoded Security System (DESS™) with start/stop button  | RF D igitally Encoded Security System (DESS™) with start/stop button  | RF D igitally Encoded Security System (DESS™) with start/stop button  |
|                       | Lighting                     | LED headlight<br>LED taillights   | LED headlight<br>LED taillights   | LED headlight<br>LED taillights   | LED headlight<br>LED signature<br>LED taillights  |
|                       | Winch                        | N/A   | N/A   | N/A   | N/A   |
|                       | Magneto                      | 650 W   | 850 W   | 850 W   | 850 W   |
|                       | Protection                   | Integrated frontbum per Quarterdoors<br>HM W PE fullskid plate<br>Rear tow hook   | Integrated frontbum per Quarterdoors<br>HM W PE fullskid plate<br>Rear tow hook   | Integrated frontbum per Quarterdoors<br>HM W PE fullskid plate<br>Rear tow hook   | Integrated frontbum per Quarterdoors<br>Fullmoof<br>4-point harness with shoulder pads<br>HM W PE fullskid plate<br>Rear tow hook                                       |

\*Sm art-Lok was developed in conjunction with TEAM Industries, a market leader in the drive train industry.

\*\*Sm art-Shox was developed in conjunction with Tractive Industries, a market leader in the suspension industry.

\*\*\*6-month BRP limited warranty. B.E.S.T. team available up to 30 months.

| MAVERICK X3             |  | MAX X rs TURBO RR***  | MAX X rs TURBO RR with Smart-Shox**/***  | MAX X mr TURBO RR***  | MAX X rc TURBO RR***   |
|-------------------------|--|---|--|---|--|
|                         |  |    |   |   |   |
| COLOR OPTIONS           |  | Fairy Red & HyperSilver<br>Triple Black<br>Dazzling Blue & Carbon Black   | Fairy Red & HyperSilver<br>Triple Black<br>Dazzling Blue & Carbon Black  | HyperSilver & Legion Red  | Hybrid White & Legion Red  |
| ENGINES                 | Type   | 200 hp, Rotax® ACE Advanced Combustion Efficiency 900 cc turbocharged triple-cylinder engine, liquid-cooled with integrated intercooler and high-performance air filter |  | 200 hp, Rotax® ACE Advanced Combustion Efficiency 900 cc turbocharged triple-cylinder engine, liquid-cooled with integrated intercooler, high-performance air filter and strategically positioned engine air intake | 200 hp, Rotax® ACE Advanced Combustion Efficiency 900 cc turbocharged triple-cylinder engine, liquid-cooled with integrated intercooler and high-performance air filter  |
|                         | Fuel Delivery System   | Intelligent Throttle Control (ITC™) with Electronic Fuel Injection (EFI)  |  | Intelligent Throttle Control (ITC™) with Electronic Fuel Injection (EFI)  | Intelligent Throttle Control (ITC™) with Electronic Fuel Injection (EFI)   |
|                         | Transmission   | pDrive primary and Quick Response System X QRS-X) CVT with high airflow, L/H/N/R/P  |  | pDrive primary and Quick Response System X QRS-X) CVT, high airflow with strategically positioned CVT air intake and exhaust, L/H/N/R/P   | pDrive primary and Quick Response System X QRS-X) CVT with high airflow, L/H/N/R/P   |
|                         | Drive Train  | Lockable front differential with exclusive Smart-Lok™ True 2W D / 4W D with front diff lock / 4W D TRAIL ACT M / 4W D TRAIL   |  | Lockable front differential with exclusive Smart-Lok™ technology True 4 modes traction system : 2W D / 4W D with front diff lock / 4W D MUD / 4W D TRAIL  | Lockable front differential with exclusive Smart-Lok™ technology True 4 modes traction system : 2W D / 4W D with front diff lock / 4W D ROCK / 4W D TRAIL  |
|                         | Power Steering   | High-torque TruM ode Dynamic Power Steering (DPS™)  |  | High-torque TruM ode Dynamic Power Steering (DPS™)  | High-torque TruM ode Dynamic Power Steering (DPS™)   |
| SUSPENSIONS             | Front Suspension   | Double A-arm with sway bar / 22 in. (55.9 cm) suspension travel Trophy truck inspired arms  |  | Double arched A-arm with sway bar / 22 in. (55.9 cm) suspension travel Trophy truck inspired arms   | Trophy truck inspired double arched A-arm with sway bar / 22 in. (55.9 cm) suspension travel   |
|                         | Front Shocks   | FOX® 2.5 POD IUM RC2® Piggyback with bypass, dual-speed compression and rebound adjustments   | FOX® 2.5 POD IUM® Piggyback with bypass and Smart-Shox™ Technology featuring DDA Valve Dynamic Damping Adjustment        | FOX® 2.5 POD IUM Piggyback with QS3® compression adjustment   | FOX® 2.5 POD IUM RC2® Piggyback with bypass, dual-speed compression and rebound adjustments  |
|                         | Rear Suspension  | 4-link torsional trailing arm X (TTX) with sway bar / 22 in. (55.9 cm) suspension travel  |  | 4-link torsional trailing arm X (TTX) with sway bar and arched lower links / 22 in. (55.9 cm) suspension travel   | 4-link torsional trailing arm X (TTX) with sway bar and arched lower links / 22 in. (55.9 cm) suspension travel  |
|                         | Rear Shocks  | FOX® 3.0 POD IUM RC2® remote reservoir with bypass, dual-speed compression and rebound adjustments  | FOX® 3.0 POD IUM® remote reservoir with bypass and Smart-Shox™ Technology featuring DDA Valve Dynamic Damping Adjustment | FOX® 2.5 POD IUM Piggyback with QS3® compression adjustment and bottom-out control  | FOX® 3.0 POD IUM RC2® remote reservoir with bypass, dual-speed compression and rebound adjustments   |
| TIRES & WHEELS          | Front / Rear Tires<br>Wheels<br>M axis Cambion® 32 x 10 x 14 in. 14 in. cast-aluminum beadlock |   | TPC Nyrtyl 30 x 9 / 11 x 14 in. 14 in. cast-aluminum beadlock  | M axis Liberty® 32 x 10 x 15 in. 15 in. cast-aluminum beadlock  |  |
| BRAKES                  | Front  | Dual 262 mm disc brakes with hydraulic twin-piston calipers   |  | Dual 262 mm disc brakes with hydraulic twin-piston calipers   | Dual 262 mm disc brakes with hydraulic twin-piston calipers  |
|                         | Rear   | Dual 248 mm disc brakes with hydraulic twin-piston calipers   |  | Dual 248 mm disc brakes with hydraulic twin-piston calipers   | Dual 248 mm disc brakes with hydraulic twin-piston calipers  |
| DIMENSIONS & CAPACITIES | Estimated Dry Weight   | 1,924 lb (872.7 kg)   | 1,942 lb (880.9 kg)  | 1,991 lb (903.1 kg)   | 2,103 lb (956 kg)  |
|                         | Chassis / Cage   | Dual-phase 980 steel  |  | Dual-phase 980 steel  | Dual-phase 980 steel   |
|                         | L x W x H  | 165 x 72.7 x 68.5 in. (419.1 x 184.7 x 174 cm)  |  | 165 x 74.2 x 68 in. (419.1 x 188.5 x 172.7 cm)  | 165 x 72.7 x 68.5 in. (419.1 x 184.7 x 174 cm)   |
|                         | Wheelbase  | 135 in. (342.9 cm)  |  | 135 in. (342.9 cm)  | 135 in. (342.9 cm)   |
|                         | Ground Clearance   | 16 in. (40.6 cm)  |  | 16 in. (40.6 cm)  | 16 in. (40.6 cm)   |
|                         | Rack Capacity  | 150 lb (68 kg) with LHQ® quick-attach   |  | 150 lb (68 kg) with LHQ® quick-attach   | 150 lb (68 kg) with LHQ® quick-attach  |
|                         | Storage Capacity   | Total: 3 gal (11.4 L)   |  | Total: 3 gal (11.4 L)   | Total: 3 gal (11.4 L)  |
|                         | Fuel Capacity  | 10.5 gal (40 L)   |  | 10.5 gal (40 L)   | 10.5 gal (40 L)  |
| FEATURES                | Gauge  | 7.6 in. wide digital display with keypad  |  | 7.6 in. wide digital display with keypad  | 7.6 in. wide digital display with keypad   |
|                         | Instrumentation  | DC outlet (10 A)  |  | DC outlet (10 A)  | DC outlet (10 A)   |
|                         | Anti-theft System  | RF D igitally Encoded Security System (DESS™) with start/stop button  |  | RF D igitally Encoded Security System (DESS™) with start/stop button  | RF D igitally Encoded Security System (DESS™) with start/stop button   |
|                         | Lighting   | LED headlight<br>LED signature<br>LED taillights  |  | LED headlight<br>LED signature<br>LED taillights  | LED headlight<br>LED signature<br>LED taillights   |
|                         | Winch  | N/A   |  | 4,500 lb (2,041 kg) winch with synthetic rope   | 4,500 lb (2,041 kg) winch with synthetic rope  |
|                         | Magneto  | 850 W   |  | 850 W   | 850 W  |
|                         | Protection   | Integrated front bumper per Quarterdooms Fullmoof 4-point harness with shoulder pads HM W PE fullskiplate Rear tow hook   |  | Front bumper per Halfdooms Fullmoof Front and rear tow hooks HM W PE fullskiplate   | Front bumper per Halfdooms Fullmoof Intusion bar 4-point harness with shoulder pads UHM W PE rock sliders HM W PE skid plates Full heavy-duty with differential/underbumper per front and rear suspension arm Rear tow hook Trailing Arm protector Lower A-arm protector |

\*Smart-Lok was developed in conjunction with TEAM Industries, a market leader in the drive train industry.  
 \*\*Smart-Shox was developed in conjunction with Tractrix Industries, a market leader in the suspension industry.  
 \*\*\*6-month BRP limited warranty. BEST term available up to 30 months.



---

# MAVERICK X3 ACCESSORIES

---



# BUNDLE UP TOGETHER AFTER IT. YOUR MAVERICK X3 BUNDLES

## STEP 1: CHOOSE YOUR ESSENTIAL BUNDLE

|          |                                     | Maverick X3 | Maverick X3 MAX |
|----------|-------------------------------------|-------------|-----------------|
| STARTER  | Sport Roof                          | 715005521   | 715003750       |
|          | Tinted Half Windshield              | 715004291   | 715004291       |
|          | Rear Wind Screen                    | 715006701   | 715006701       |
|          | Rally Side Mirrors                  | 715005262   | 715005262       |
|          | Front Lower Door Panels             | 715002903   | 715002903       |
|          | Rear Lower Door Panels              | N/A         | 715003751       |
| ADVANCED | Electronic Device Holder            | 715002874   | 715002874       |
|          | Shoulder Storage Bag                | 715004277   | 715004277       |
|          | LinQ 8 Gal (30L) Cooler Box         | 715004778   | 715004778       |
| PEAK     | Rear View Mirror and Camera Monitor | 715009410   | 715009410       |
|          | Front Pre-Runner Bumper             | 715002878   | 715002878       |
|          | Fender Flares                       | 715002973   | 715002973       |
|          | LinQ Tool Kit                       | 715006829   | 715006829       |
|          | Adventure Roof Rack                 | 715006225   | 715003868       |

## STEP 2: PICK YOUR ADD-ON BUNDLE

|               |   | Maverick X3 | Maverick X3 MAX |
|---------------|---|-------------|-----------------|
| AUDIO         | Can-Am Audio Roof                         | 715007130   | 715006709       |
|               | Can-Am Audio Roof Flip Kit                | 715007131   | 715007131       |
|               | Can-Am Subwoofer                          | 715004956   | 715004956       |
|               | Can-Am Amplifier Kit                      | 715007227   | 715007227       |
| LIGHT         | Light Support Bar                         | 715003529   | 715003529       |
|               | Light Power Cable                         | 715007117   | 715007117       |
|               | 40" Baja Designs OnX6 Arc LED Light Bar   | 710006818   | 710006818       |
|               | Chase Lights                              | 715009887   | 715009887       |
| RIDER         | 4-Point Harness (Driver)                  | 715005021   | 715005021       |
|               | 4-Point Harness (Passenger)               | 715005022   | 715005022       |
|               | Lonestar Racing Fire Extinguisher Support | 715007320   | 715007320       |
|               | Fire Extinguisher                         | 295100833   | 295100833       |
| CABIN STORAGE | Overhead Storage Bag                      | 715004275   | 715004275       |
|               | Upper Door Storage Bags                   | 715004276   | 715004276       |
|               | Lower Door Panel Storage Bags             | 715004355   | 715004355       |
|               | Front Storage Bag                         | N/A         | 715004888       |





|                   |                 |                  |                 |
|-------------------|-----------------|------------------|-----------------|
| <b>Sport Roof</b> | Maverick X3     | <b>715005521</b> | <b>\$459.99</b> |
|                   | Maverick X3 MAX | <b>715003750</b> | <b>\$859.99</b> |



- Impact-resistant injected polypropylene.
- Excellent protection from the elements.
- Provides excellent downhill visibility.
- Windshield compatible.
- Standard on X3sm model.
- Easy, tool-less installation and removal with quick-release ratchet fasteners and Velcro straps.

|                                |                              |                  |                 |
|--------------------------------|------------------------------|------------------|-----------------|
| <b>ProVent Roof Module Kit</b> | Maverick X3, Maverick X3 MAX | <b>715005279</b> | <b>\$234.99</b> |
|--------------------------------|------------------------------|------------------|-----------------|



- Provides fresh air in the cab area.
- Optimal performance with full cab enclosure.
- 4 vents provide infinite adjustment of air flow for driver and passenger.
- Filter and pre-filter to limit dust intrusion.
- Easy cleaning of filter and pre-filter.
- Patent pending water management system to keep water out of cabin while maintaining air flow.
- Outer plug closes air intake completely for interior heavy weather.
- Sport Roof requires ProVent Module Adapter Kit.
- Not compatible with roof-mounted LED bars, roof racks (715006225/715003868) or roof liners, Lonestar Roof, and Bimini tops.

|   |                 |                  |                |
|---|-----------------|------------------|----------------|
| <b>ProVent Roof Module Adapter Kit for Sport Roof</b><br><i>(Not illustrated)</i> | Maverick X3     | <b>715006199</b> | <b>\$92.99</b> |
|   | Maverick X3 MAX | <b>715006371</b> |                |

- Adapter for fitting ProVent Roof Module Kit onto Maverick X3.
- Includes roof adapter and hardware.
- Requires ProVent Roof Module Kit (715005279).

|                      |             |                             |                 |
|----------------------|-------------|-----------------------------|-----------------|
| <b>Aluminum Roof</b> | Maverick X3 | ■ <b>715004224</b> - Black  | <b>\$709.99</b> |
|                      |             | ■ <b>715002900</b> - Silver | <b>\$619.99</b> |



- Formed aluminum roof 0.09" (2.3mm) thick.
- Durable and lightweight.
- Sporty look.
- Windshield compatible.
- Easy and tool-less installation.

|   |                 |                  |                 |
|---|-----------------|------------------|-----------------|
| <b>Bimini<sup>+</sup> Roof with Sun Visor</b> | Maverick X3     | <b>715002901</b> | <b>\$359.99</b> |
|   | Maverick X3 MAX | <b>715003749</b> | <b>\$389.99</b> |



- Heavy-duty canvas made of UV-resistant solution-dyed polyester.
- Innovative soft top comes with a hard visor that allows for storage of rolled-up soft top.
- Easy, tool-less installation and removal with quick-release ratchet fasteners and Velcro straps.

|                         |                              |                  |                 |
|-------------------------|------------------------------|------------------|-----------------|
| <b>Tinted Sun Visor</b> | Maverick X3, Maverick X3 MAX | <b>715007098</b> | <b>\$279.99</b> |
|-------------------------|------------------------------|------------------|-----------------|



- Tinted polycarbonate construction.
- Extra protection for driver and passenger from the sun.
- Not compatible with Aluminum Roof and Full Windshields.

|                                      |  |                            |                   |
|--------------------------------------|--|----------------------------|-------------------|
| <b>Lonestar Racing Aluminum Roof</b> | Maverick X3 produced after January 1, 2017 | ■ <b>715005507</b> - Black | <b>\$899.99</b>   |
|                                      | Maverick X3 MAX                            | ■ <b>715005515</b> - Black | <b>\$1,609.99</b> |



- 0.083" (2.1mm) thick aluminum roof.
- Durable and lightweight.
- Enhances the vehicle's racing appearance thanks to an authentic sporty look combined with unique graphics.
- Offers you protection from the elements with a personalized touch.
- Lower profile than other roofs.
- Compatible with Lonestar Racing Light Bar Racks.
- Not compatible with LinQ Pivoting Rack, Light Support Bar and Full Windshields.
- "Lonestar Racing for Can-Am" branded.
- Includes mild intrusion bars for installation.

# SOFT CAB ENCLOSURE



## Soft Cab Enclosure



- Protection for rider and passenger from the elements.
- For added cabin comfort, complete your cab enclosure with Cab Seal Kit.
- Includes:
  - Bin in roof with sun visor
  - Full windshield - hardcoated
  - Upper soft door panels
  - Front lower door panels
  - Soft rear window

|                                       |           |            |
|---------------------------------------|-----------|------------|
| Maverick X3 (except X3 M models)      | 715003754 | \$2,389.99 |
| Maverick X3 M AX (except X3 M models) | 715003755 | \$3,319.99 |

## Cab Seal Kit

(Not illustrated)

- Prevents dirt, dust and wind infiltration in the cab area.
- Improves cabin comfort for driver and passenger.
- Recommended with Soft Cab Enclosures.

|                  |           |         |
|------------------|-----------|---------|
| Maverick X3      | 715004433 | \$49.99 |
| Maverick X3 M AX | 715004434 | \$33.99 |

# WINDSHIELDS & WIND PROTECTION



## Windshields

### PowerFlip Windshield



- The PowerFlip Windshield is equipped with electric cylinders that allow the rider to adjust the windshield opening at the touch of a button.
- Windshield is made of hardcoated polycarbonate with a rubber seal contour and a tinted top section.
- Allows you to quickly adapt to changing conditions by adjusting the windshield as you go.
- Can be fully opened for optimal visibility and ventilation, fully closed for maximum protection from the elements, and in between, you have an infinite number of opening possibilities depending on protection, visibility and airflow preferences.
- Compatible with Can-Am roofs.

|                               |           |            |
|-------------------------------|-----------|------------|
| Maverick X3, Maverick X3 M AX | 715007097 | \$1,559.99 |
|-------------------------------|-----------|------------|

### Windshield Wiper for PowerFlip Windshield



- An ideal way to keep your windshield clear in rain or while riding through mud and water.
- Wiper from the top allows windshield pivoting. Includes single-speed wiper and washer fluid dispenser.
- Wiper mechanism and washer fluid dispenser perfectly concealed within the vehicle.
- Must be installed with the PowerFlip Windshield (sold separately).

|                               |           |          |
|-------------------------------|-----------|----------|
| Maverick X3, Maverick X3 M AX | 715006310 | \$839.99 |
|-------------------------------|-----------|----------|

### Provent Windshield



- High-impact-resistant Quantum hardcoated polycarbonate full windshield.
- Controllable vents to manage airflow.
- Optimal performance with full cab enclosure.
- Channels air into the cabin, defogs windshield, fully closes to eliminate airflow.
- One upper vent and one lower vent with pre-filters.
- Formed polycarbonate construction for enhanced rigidity.
- Protects driver and passenger from the elements.
- Quick and easy tool-less installation or removal.
- Not compatible with wiper kits and Wet Sounds Stealth 6 Ultra HD Can-Am Edition Sound Bar.
- Upper vent channels air into the cabin.
- Lower vents defog windshield.
- Provides excellent optical clarity and better abrasion resistance.

|                               |           |            |
|-------------------------------|-----------|------------|
| Maverick X3, Maverick X3 M AX | 715005277 | \$1,019.99 |
|-------------------------------|-----------|------------|

### Glass Windshield



- Curved and laminated glass full windshield.
- Seals firmly against the cage and protects rider and passenger from the elements.
- Provides the best optical clarity and abrasion resistance.
- Must be used with Windshield Wiper & Washer Kit to maintain clear visibility during severe riding conditions, such as mud riding.
- Recommended to use with rear window protection to maximize comfort for passenger.

|                               |           |            |
|-------------------------------|-----------|------------|
| Maverick X3, Maverick X3 M AX | 715008859 | \$1,189.99 |
|-------------------------------|-----------|------------|

|   |                              |           |            |
|---|------------------------------|-----------|------------|
| <b>Glass Windshield with Wiper &amp; Washer Kit</b> | Maverick X3, Maverick X3 MAX | 715008858 | \$1,729.99 |
|---|------------------------------|-----------|------------|



- Complete kit that includes a curved and laminated glass windshield with a single-speed wiper and washer fluid dispenser.
- Seals firmly against the cage and protects rider and passenger from the elements.
- An ideal way to keep your windshield clear in rain, or while riding through mud and water.
- Recommended to use with rear wind protection to maximize comfort for passenger.

|                        |                              |           |          |
|------------------------|------------------------------|-----------|----------|
| <b>Full Windshield</b> | Maverick X3, Maverick X3 MAX | 715002907 | \$549.99 |
|------------------------|------------------------------|-----------|----------|



- High-impact-resistant durable polycarbonate full windshield.
- Formed polycarbonate construction for enhanced rigidity.
- Formulated to be non-yellowing, non-crazing, non-cracking with excellent UV resistance and optical clarity.
- Protects driver and passenger from the elements.
- Quick and easy toolless installation or removal.
- Recommended to use with rear wind protection to maximize comfort for passenger.

|                                     |                              |           |          |
|-------------------------------------|------------------------------|-----------|----------|
| <b>Full Windshield – Hardcoated</b> | Maverick X3, Maverick X3 MAX | 715004417 | \$799.99 |
|-------------------------------------|------------------------------|-----------|----------|



- High-impact-resistant Quantum hardcoated polycarbonate full windshield.
- Formed polycarbonate construction for enhanced rigidity.
- Provides excellent optical clarity and better abrasion resistance.
- Protects driver and passenger from the elements.
- Quick and easy toolless installation or removal.
- Recommended to use with rear wind protection to maximize comfort for passenger.
- Can be used with the Windshield Wiper and Washer Kit (715004762).

|                        |                              |   |          |
|------------------------|------------------------------|---|----------|
| <b>Half Windshield</b> | Maverick X3, Maverick X3 MAX | <input type="checkbox"/> 715002909 - Clear  | \$369.99 |
|                        |                              | <input type="checkbox"/> 715004291 - Tinted | \$399.99 |



- High-impact-resistant durable polycarbonate half windshield.
- Formed polycarbonate construction for enhanced rigidity.
- Formulated to be non-yellowing, non-crazing, non-cracking with excellent UV resistance and optical clarity.
- Protects driver and passenger from the elements.
- Features reverse angle lip to deflect air flow.
- Quick and easy toolless installation or removal.

|  |  |           |          |
|--|--|-----------|----------|
| <b>Windshield Wiper &amp; Washer Kit</b> | Maverick X3, Maverick X3 MAX Fit with Full Windshield Hardcoated (715004417) | 715004762 | \$699.99 |
|  | Maverick X3, Maverick X3 MAX Fit with Glass Windshield (715008859)           | 715003282 |          |



- An ideal way to keep your windshield clear in rain, or while riding through mud and water.
- Includes single-speed wiper and washer fluid dispenser.
- Wiper mechanism and washer fluid dispenser perfectly concealed within the vehicle.

|                             |                              |           |          |
|-----------------------------|------------------------------|-----------|----------|
| <b>NEW Manual Wiper Kit</b> | Maverick X3, Maverick X3 MAX | 715009424 | \$119.99 |
|-----------------------------|------------------------------|-----------|----------|



- Single manual wiper that can be used to clear windshield of debris.
- Easy to install system that requires no electrical hookup.
- Large ergonomic handle provides a good grip over the entire sweeping surface.
- Compatible with glass and hardcoated windshields that use top mounted wipers.

## Wind Protection

|                         |  |           |          |
|-------------------------|--|-----------|----------|
| <b>Rear Wind Screen</b> | Maverick X3, Maverick X3 MAX<br>(except XM models) | 715006701 | \$129.99 |
|-------------------------|--|-----------|----------|



- Full rear mesh screen reduces windshield backdraft for added cabin comfort.
- Installs quickly and easily on roll cage.
- Large white Can-Am logo on black mesh.

|                                  |  |           |          |
|----------------------------------|--|-----------|----------|
| <b>Rear Polycarbonate Window</b> | Maverick X3, Maverick X3 MAX<br>(except XM models) | 715006387 | \$369.99 |
|----------------------------------|--|-----------|----------|



- High-impact resistant polycarbonate window.
- Blocks windshield backdraft or dust and rain from entering for added cabin comfort.
- Quick and easy toolless installation.
- Ready for M/TX Audio System Rear Speakers.

|                         |  |           |          |
|-------------------------|--|-----------|----------|
| <b>Soft Rear Window</b> | Maverick X3, Maverick X3 MAX<br>(except XM models) | 715006702 | \$129.99 |
|-------------------------|--|-----------|----------|



- Clear, flexible window made from transparent vinyl.
- Resists cold-cracking to -4°F (-20°C).
- Ideal for preventing backdraft of dust or rain in harsh environments.
- Quick toolless installation.

## MIRRORS



|                                  |                              |           |          |
|----------------------------------|------------------------------|-----------|----------|
| <b>NEW Aluminum Side Mirrors</b> | Maverick X3, Maverick X3 MAX | 715007363 | \$329.99 |
|----------------------------------|------------------------------|-----------|----------|

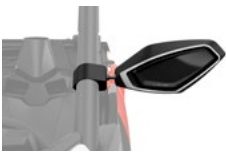

- Sleek design.
- High-quality black anodized aluminum for extreme durability.
- The convex surface provides a wider field of view and better visibility around the unit.
- Can be installed at any height on the cage A-pillar for optimized ride vision.
- Possibility to install the Integrated LED Side Mirror Lights (715007185).
- Adjustable ball-joint mirrors.
- Possibility to fold down the mirrors (fold-away mechanism).
- Not compatible with Glass Windshield.
- Sold in pairs.

|                         |                              |           |          |
|-------------------------|------------------------------|-----------|----------|
| <b>NEW Side Mirrors</b> | Maverick X3, Maverick X3 MAX | 715007188 | \$199.99 |
|-------------------------|------------------------------|-----------|----------|



- Sleek design.
- High-impact resistant plastic mirrors.
- The convex surface provides a wider field of view and better visibility around the unit.
- Can be installed at any height on the cage A-pillar for optimized ride vision.
- Adjustable ball-joint mirrors.
- Possibility to fold down the mirrors (fold-away mechanism).
- Not compatible with Glass Windshield.
- Sold in pairs.

|                     |                              |   |          |
|---------------------|------------------------------|---|----------|
| <b>Side Mirrors</b> | Maverick X3, Maverick X3 MAX | 715004236<br>• For stock quarter doors<br>715005315<br>• For aluminum doors | \$299.99 |
|---------------------|------------------------------|---|----------|



- Rugged cast aluminum mount with black nylon cover.
- Multiposition adjustable ball-joint mounted mirrors.
- Convex optics for a wide viewing angle.
- Spring-loaded pivots let mirrors fold back completely.
- Door mounted.
- Compatible with Upper Soft Door Panels.
- Sold in pairs.



|                            |                              |                  |                 |
|----------------------------|------------------------------|------------------|-----------------|
| <b>Racing Side Mirrors</b> | Maverick X3, Maverick X3 MAX | <b>715002898</b> | <b>\$259.99</b> |
|----------------------------|------------------------------|------------------|-----------------|



- Race-inspired design features rugged black nylon construction with coated cast-aluminum mount.
- Dual adjustment provides optimal field of view (FOV).
- Multiposition adjustable ball-joint mounted mirrors.
- Flat optics deliver improved distance perception.
- Spring-loaded pivots let mirrors fold back completely.
- Not compatible with Lonestar Racing Light Racks, Upper Soft Door Panels or Flip Audio Roof Kit (715007131).
- Sold in pairs.

|                           |                              |                  |                 |
|---------------------------|------------------------------|------------------|-----------------|
| <b>Rally Side Mirrors</b> | Maverick X3, Maverick X3 MAX | <b>715005262</b> | <b>\$199.99</b> |
|---------------------------|------------------------------|------------------|-----------------|



- Sleek design with unique racing style.
- High-quality black molded aluminum for extreme durability.
- 4" (10 cm) convex surface provides a wider field of view and better visibility around the unit.
- Can be installed at any height on the cage A-pillar for optimized ride vision.
- Multiposition adjustable ball-joint mounted mirrors.
- Spring-loaded pivots let mirrors fold back completely.
- Sold in pairs.
- Not compatible with Glass Windshield.

|   |                              |                  |                 |
|---|------------------------------|------------------|-----------------|
| <b>Rear Mirror &amp; Camera Monitor</b> | Maverick X3, Maverick X3 MAX | <b>715009410</b> | <b>\$499.99</b> |
|---|------------------------------|------------------|-----------------|



- Fully waterproof rearview mirror and monitor kit.
- See exactly what you need to see with the multiple camera feeds from the rearview camera.
- This unit replaces the stock rearview mirror (the screen is integrated in the unit's replacement rearview mirror).
- The camera uses infrared light for night vision capabilities.

## DOORS



|                            |                              |                         |                 |
|----------------------------|------------------------------|-------------------------|-----------------|
| <b>Aluminum Half Doors</b> | Maverick X3, Maverick X3 MAX | <b>715007971</b> -Front | <b>\$849.99</b> |
|                            | Maverick X3 MAX              | <b>715007972</b> -Rear  |                 |



- Lightweight half doors made of formed 1/2" (12 mm) thick aluminum.
- Smooth finish.
- Engineered for maximum rigidity and durability.
- Designed for a perfect fit and seamless integration with the vehicle's lines.
- Contoured with a thick seal for better protection from the elements.
- Easy installation using the standard door frame.
- Includes the easy-to-operate Deluxe Door Handles.
- Compatible with the Upper Soft Door Panels, the Window Nets and Upper Door Storage Bags.
- Not compatible with the Lower Door Panel Storage Bags.
- Sold in pairs.

|                            |                              |                         |                 |
|----------------------------|------------------------------|-------------------------|-----------------|
| <b>Deluxe Door Handles</b> | Maverick X3, Maverick X3 MAX | <b>715004758</b> -Front | <b>\$204.99</b> |
|                            | Maverick X3 MAX              | <b>715004860</b> -Rear  |                 |

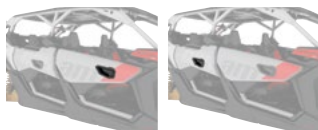

- Convert the standard door straps into easy-to-access door handles.
- Include inside and outside handles for each door.
- Greatly facilitate door opening.
- Standard on accessory Aluminum Half Doors.
- Sold in pairs.

|                          |                              |                         |                 |
|--------------------------|------------------------------|-------------------------|-----------------|
| <b>Lower Door Panels</b> | Maverick X3, Maverick X3 MAX | <b>715002903</b> -Front | <b>\$399.99</b> |
|                          |                              | <b>715003751</b> -Rear  |                 |

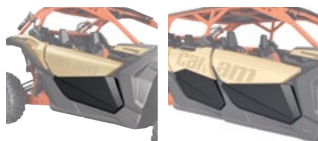

- Robust injection-molded polypropylene construction designed to match vehicle.
- Extend stock doors at bottom to protect and seal cab area.
- A great-looking add-on.
- Easy and quick installation.
- Sold in pairs.

|  |                  |                  |          |
|--|------------------|------------------|----------|
|  | Maverick X3      | 715006693 -Front |          |
|  | Maverick X3 M AX | 715004694 -Front |          |
|  | Maverick X3 M AX | 715006700 -Rear  | \$199.99 |

## Window Nets



- Window mesh screen provides protection from wind.
- Can be easily lowered in seconds.
- Sold in pairs.
- Not compatible with Can-Am Audio Roof.

|  |  |                    |            |
|--|--|--------------------|------------|
|  | Maverick X3 (except X3 M models)         | 715008091 -2 doors | \$839.99   |
|  | Maverick X3 M AX (except X3 M AX models) | 715008092 -4 doors | \$1,609.99 |

## Upper Soft Door Panels



- Weather-resistant panels reinforced with aluminum frame offer good protection from the elements.
- Extend stock quarter doors at the top.
- Made of heavy-duty UV-resistant solution-dyed polyester canvas for excellent resistance to tear and abrasion.
- Zip-down window shade of laminated polished vinyl material for added ventilation.
- To be combined with the Lower Door Panels to obtain complete door kits for your vehicle.
- Not compatible with Racing Side Mirrors and Can-Am Audio Roof.

# SEAT ACCESSORIES



|  |                               |                      |          |
|--|-------------------------------|----------------------|----------|
|  |                               | 715008033 -Driver    | \$264.99 |
|  | Maverick X3, Maverick X3 M AX | 715008034 -Passenger | \$219.99 |

## 4-Point Harness



- Exclusive controlled decelerator technology (patent pending) absorbs additional energy in case of accident.
- Designed to offer maximum riding comfort.
- Easy one-click latch and release.
- Patent pending.
- Not EC compliant.

|  |                               |                      |          |
|--|-------------------------------|----------------------|----------|
|  |                               | 715005021 -Driver    | \$309.99 |
|  | Maverick X3, Maverick X3 M AX | 715005022 -Passenger | \$284.99 |

## Retractable 4-Point Harness



- Convenient harness allows you to move freely in your seat, and at the same time fully benefit from the extra support given by the 4-point attachments.
- Makes it easier to buckle up and requires fewer adjustments when switching passenger or driver.
- Retractor Protector (707900653) is required for installation on front seats of M AX models.
- Compatible with rear passenger seats on M AX models.
- Standard on select Maverick X3 models.

|  |  |           |          |
|--|--|-----------|----------|
|  |  | 707900653 | \$109.99 |
|--|--|-----------|----------|

## Retractor Protector (Not illustrated)

- Protective pad required for the installation of the Retractable 4-Point Harness on front seats of M AX models.
- Protects the passengers from the retractor mechanism.
- Sold individually.

|  |                               |           |         |
|--|-------------------------------|-----------|---------|
|  | Maverick X3, Maverick X3 M AX | 715002894 | \$45.99 |
|--|-------------------------------|-----------|---------|

## Seat Belt Shoulder Pads



- Provide additional riding comfort by preventing seat belt from rubbing on neck and shoulder.
- Fit with stock 3-point seat belts and 4-point harness.
- Easy Velcro installation.
- Can-Am branded.
- Sold in pairs for driver and passenger.

# HMWPE SKID PLATES

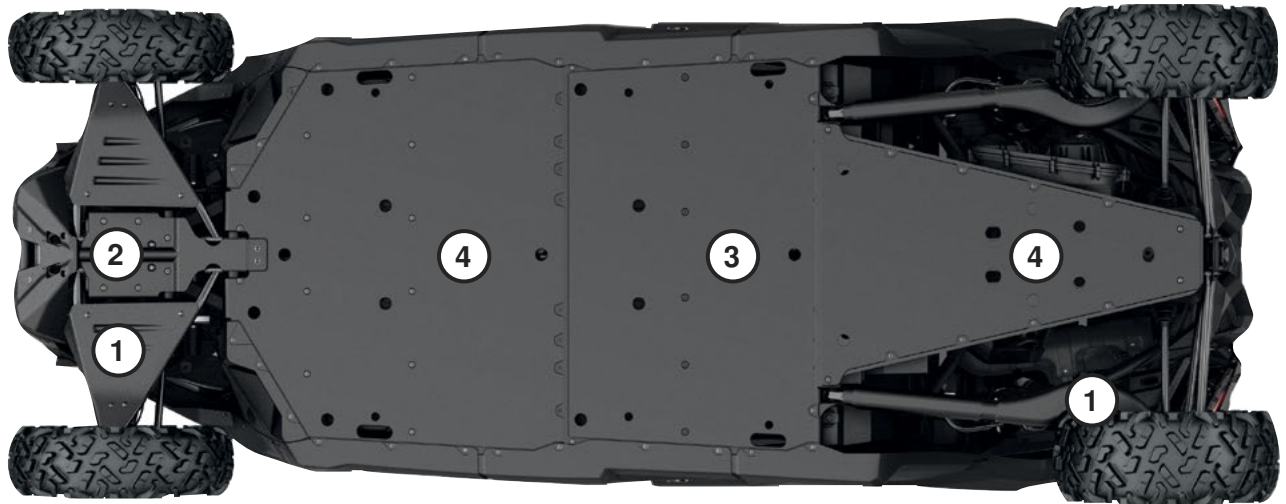

Our plastic plates glide smoothly and silently over obstacles, offering great protection in rough terrain. Made of abrasion-resistant thermoformed 1/2" (10 mm) thick High Molecular Weight Polyethylene (HMWPE).

- Lighter than aluminum.
- Superior stress crack resistance.
- High impact strength.







## MAVERICK X3, MAVERICK X3 MAX

| HMWPE Skid Plates are standard on Maverick X3 X-rc models. | Maverick X3 64" models | Maverick X3 Max 64" models | Maverick X3, Maverick X3 Max 72" models (except Base models) | Maverick X3 Base 72" models | Maverick X3 Max Base 72" models |
|--|------------------------|----------------------------|--|-----------------------------|---------------------------------|
| <b>HMWPE Skid Plate Protection Kit</b>                     |                        |                            |  |                             |                                 |
|  | 715003713              | 715003747                  | 715003718  | 715006767                   | 715006769                       |
| <b>Individual HMWPE Skid Plates</b>                        |                        |                            |  |                             |                                 |
| ① HMWPE Front A-Arm and Trailing Arm Protectors            | 715002905              | 715002905                  | 715003552  | 715003552                   | 715003552                       |
| ② HMWPE Front Skid Plate                                   | 715003933              | 715003933                  | 715003933  | 715003933                   | 715003933                       |
| ③ HMWPE Central Skid Plate                                 | —                      | 715003731                  | Standard on X-rc models only                                 | —                           | 715003731                       |
| ④ HMWPE Underbelly Plate                                   | 715004904              | 715004904                  | Standard on X-rc models only                                 | 715004904                   | 715004904                       |

# BUMPERS & GUARDS



## Bumpers

|  |  |  |                 |
|--|--|--|-----------------|
| <b>Front Pre-Runner Bumper</b>   | Maverick X3, Maverick X3 M AX  | ■ 715002878 · Black<br>■ 715003433 · Can-Am Red                        | <b>\$449.99</b> |
|    | <ul style="list-style-type: none"> <li>• Made of 1.5" (38 cm) diameter steel tubing with a 1/8" (3 mm) aluminum plate for extra durability.</li> <li>• Inside and outside anti-corrosion coating with durable powdercoat finish.</li> <li>• Added heavy-duty protection in extreme driving conditions.</li> <li>• Integrated with mounting plate and mountpoints for lights.</li> </ul>  |  |                 |
| <b>Rear Pre-Runner Bumper</b>  | Maverick X3, Maverick X3 M AX  | ■ 715002880 · Black<br>■ 715003436 · Can-Am Red                        | <b>\$449.99</b> |
|    | <ul style="list-style-type: none"> <li>• Extra-durable 1.5" (38 cm) diameter steel tubing with a 1/8" (3 mm) aluminum plate.</li> <li>• Inside and outside anti-corrosion coating with durable powdercoat finish.</li> <li>• Protects vehicle bodywork and exhaust system.</li> <li>• Rear Receiver Hitch compatible.</li> <li>• Required for installation of the Rear Cage Extension.</li> </ul>  |  |                 |
| <b>Dune Front Bumper</b>   | Maverick X3, Maverick X3 M AX  | ■ 715002961 · Black<br>■ 715003432 · Can-Am Red                        | <b>\$359.99</b> |
|    | <ul style="list-style-type: none"> <li>• Made of 1.5" (38 cm) diameter aluminum tubing with a 1/8" (3 mm) aluminum plate.</li> <li>• Inside and outside anti-corrosion coating with durable powdercoat finish.</li> <li>• Provides added protection without sacrificing the agility and performance advantages of a lighter weight design.</li> <li>• Features a more pronounced attack angle and integrated mounting points for lights.</li> <li>• Not compatible.</li> </ul>   |  |                 |
| <b>Dune Rear Bumper</b>  | Maverick X3, Maverick X3 M AX 2021 & prior<br>Maverick X3, Maverick X3 M AX 2022 & up  | ■ 715002962 · Black<br>■ 715003437 · Can-Am Red<br>■ 715009242 · Black | <b>\$359.99</b> |
|  | <ul style="list-style-type: none"> <li>• Made of 1.5" (38 cm) diameter aluminum tubing with a 1/8" (3 mm) aluminum plate.</li> <li>• Inside and outside anti-corrosion coating with durable powdercoat finish.</li> <li>• Provides added protection without sacrificing the agility and performance advantages of a lighter weight design.</li> <li>• Protects vehicle bodywork and exhaust system.</li> <li>• Rear hitch compatible.</li> <li>• Not compatible with Rear Cage Extension and Lonestar Racing Spare Tire Holder.</li> </ul> |  |                 |
| <b>Xrc/ Xmr Front Bumper</b>   | Maverick X3, Maverick X3 M AX  | ■ 715004788 · Black  | <b>\$479.99</b> |
|  | <ul style="list-style-type: none"> <li>• Made of 1.5" (38 cm) diameter steel tubing with a 1/8" (3 mm) aluminum plate.</li> <li>• Inside and outside anti-corrosion coating with durable powdercoat finish on steel tubing.</li> <li>• Offers all the essential features required for technical driving: low front-end protection, support base for winch installation and integrated tow hook.</li> <li>• Standard on Maverick X3 Xrc and Xmr models.</li> <li>• Not compatible with winches with steel cable.</li> </ul>                 |  |                 |
| <b>Lonestar Racing Front Bumper</b>  | Maverick X3, Maverick X3 M AX<br>(not compatible Xmr and Xrc models)   | ■ 715005510 · Hyper Silver<br>■ 715005509 · Black                      | <b>\$469.99</b> |
|  | <ul style="list-style-type: none"> <li>• Made of 1.5" (38 cm) diameter steel tubing with durable powdercoat finish and a 1/8" (3 mm) thick aluminum plate for added vehicle-front protection in extreme driving conditions.</li> <li>• Sleek styling enhances the vehicle's race-inspired look.</li> <li>• Not compatible.</li> <li>• Not compatible with 10" (25 cm) Baja Designs OnX6 LED Light Bar.</li> <li>• Not compatible with stock Smart-Shox.</li> </ul>   |  |                 |



## Lonestar Racing Rear Bumper

Maverick X3, Maverick X3 MAX 2021 & prior

- 715005512 -HyperSilver
- 715005511 -Black
- 715004162 -Can-Am Red

**\$509.99**



- Made of 1.5" (38 cm) diameter steel tubing with a durable powder coat finish.
- Provides additional vehicle rear bodywork and exhaust system protection in extreme driving conditions.
- Sleek styling enhances the vehicle's race-inspired look.
- Compatible with Lonestar Racing Spare Tire Holder.
- No hitch compatible.

## S3<sup>+</sup> Front Bumper

Maverick X3, Maverick X3 MAX

- 715004867 -Black

**\$529.99**



- Made of 1.5" (38 cm) diameter steel tubing with a 1/8" (3 mm) aluminum plate for extra durability.
- Inside and outside anti-corrosion coating with a durable powder coat finish.
- Added heavy-duty protection in extreme driving conditions.
- Integrated winch support plate and mounting points for lights.
- Hook support anchor allows you to keep the winch hook within easy reach when riding in deep mud.
- "S3 for Can-Am" branded.
- Winch not included.

## S3 Rear Bumper

Maverick X3, Maverick X3 MAX 2021 & prior

- 715004869 -Black

**\$719.99**



- Made of extra-durable 1.5" (38 cm) diameter steel tubing.
- Inside and outside anti-corrosion coating with a durable powder coat finish.
- Added heavy-duty protection in extreme driving conditions protects vehicle bodywork and exhaust system.
- Permits installation of a winch at a higher location to improve accessibility in muddy conditions.
- "S3 for Can-Am" branded.
- Engineered to sustain heavy winch loads without damaging the vehicle's frame.
- Compatible with Can-Am HD and WARN VRX winches. Rear Winch Harness (715006007) is required to install a winch on the bumper.
- Includes a robust recovery hook to facilitate vehicle recovery.
- Winch not included.
- Not EC compliant.

## Rock Sliders

### Rock Sliders

Maverick X3 (except X3m)

- 715002963 -Black
- 715003438 -Can-Am Red

**\$329.99**  
**\$369.99**

Maverick X3 MAX

- 715003730 -Black
- 715003888 -Can-Am Red

**\$449.99**  
**\$509.99**



- Made of heavy-duty 1.5" (38 cm) diameter steel tubing.
- Inside and outside anti-corrosion coating with a durable powder coat finish.
- Protect vehicle's sides and undercarriage against large obstacles.
- Support plate adds rigidity and style.
- Sold in pairs.

### Xrc UHMWPE Rock Sliders

Maverick X3

- 715004730

**\$759.99**



- Robust 1/4" (6 mm) UHMWPE construction.
- Include lower body panels and brackets for installation.
- Protect vehicle's sides and undercarriage against large obstacles.
- Lodge tight up against vehicle body for better clearance from obstacles.
- Slide smoothly over obstacles.
- Sold in pairs.

### Lonestar Racing Rock Sliders

Maverick X3 MAX

- 715005514 -HyperSilver
- 715008845 -Black
- 715008846 -Can-Am Red
- 715008847 -Black
- 715008848 -Can-Am Red

**\$399.99**  
**\$799.99**



- Race-engineered to Lonestar Racing's trademark standards for toughness, these stylishly crafted accessories will also enhance your vehicle with visual impact.
- Made of 1.5" (38 cm) diameter steel tubing with a durable powder coat finish.
- Essential protection for your vehicle's sides from large obstacles.
- Sold in pairs.
- Maverick X3 MAX: Not compatible with the Rear Aluminum Half Doors (715007972).

## Intrusion Bars

|                            |                              |   |                 |
|----------------------------|------------------------------|---|-----------------|
| <b>Front Intrusion Bar</b> | Maverick X3, Maverick X3 MAX | <span style="color: black;">■ 715002889</span> -Black<br><span style="color: red;">■ 715003435</span> -Can-Am Red | <b>\$409.99</b> |
|----------------------------|------------------------------|---|-----------------|



- Matches vehicle styling.
- Inside and outside anticorrosion coating with durable powdercoat finish steel intrusion bar.
- Tube design reduces obstructed lines of sight and blind spots for better visibility.
- Not compatible with windshield and Lonestar Racing Aluminum Roof.

|  |                              |   |                 |
|--|------------------------------|---|-----------------|
| <b>Lonestar Racing Front Intrusion Bar</b> | Maverick X3, Maverick X3 MAX | <span style="color: black;">■ 715003916</span> -Black | <b>\$469.99</b> |
|--|------------------------------|---|-----------------|



- Made of 1.5" (3.8 cm) diameter steel tubing with durable powdercoat finish.
- Enhances the racing look of the vehicle.
- Compatible with Lonestar Racing Aluminum Roof only.
- Not compatible with windshield.

|   |  |   |                 |
|---|--|---|-----------------|
| <b>Lonestar Racing Rear Intrusion Bar</b> | Maverick X3 (except X3 models),<br>Maverick X3 MAX | <span style="color: black;">■ 715003918</span> -Black | <b>\$369.99</b> |
|---|--|---|-----------------|



- Made of 1.5" (3.8 cm) diameter steel tubing with durable powdercoat finish.
- Sleek styling enhances the vehicle's race-inspired look.
- Required for the installation of the Lonestar Racing Spare Tire Holder.
- Not compatible with LinQ mounted accessories and Pre-Filter in the cargo bed.

## Other Accessories

|                      |                              |                  |                 |
|----------------------|------------------------------|------------------|-----------------|
| <b>Fender Flares</b> | Maverick X3, Maverick X3 MAX | <b>715002973</b> | <b>\$249.99</b> |
|----------------------|------------------------------|------------------|-----------------|



- Extended fender flares made from injection-molded polypropylene.
- Keep mud and debris out of vehicle.
- Designed for quick and easy installation.
- Include front and rear extensions and mounting hardware.

|  |   |   |                 |
|--|---|---|-----------------|
| <b>Lonestar Racing Spare Tire Holder</b> | Maverick X3, Maverick X3 MAX 2021 & prior<br>(except X3 models) | <span style="color: black;">■ 715003922</span> -Black | <b>\$264.99</b> |
|--|---|---|-----------------|



- Made of 1.5" (3.8 cm) diameter steel tubing with durable powdercoat finish.
- Adjustable height to fit Can-Am tires up to 30 in.
- Requires Lonestar Racing Rear Bumper and Lonestar Racing Rear Intrusion Bar for installation.
- Cannot hold the Pro Arm or Quickshot Wheel Jack and Off Road Screw Jack.
- Wheel not included.
- Not compatible with the S&B Particle Separator and LinQ accessories intended for the rear of the vehicle.

|  |                              |                  |                 |
|--|------------------------------|------------------|-----------------|
| <b>Lonestar Racing Number Plate Holder</b> | Maverick X3, Maverick X3 MAX | <b>715003943</b> | <b>\$219.99</b> |
|--|------------------------------|------------------|-----------------|



- Includes a pair of sturdy aluminum number plates that mount on either side of the vehicle rear.
- Not compatible with LinQ Pivoting Rack.
- Numbered decals are available through SCS Unlimited.
- Styling enhances the vehicle's race-inspired look while adding a personal touch.
- Black background.

|                           |   |   |                 |
|---------------------------|---|---|-----------------|
| <b>S3 Rear Pull Plate</b> | Maverick X3, Maverick X3 MAX 2021 & prior | <span style="color: black;">■ 715004870</span> -Black<br><span style="color: red;">■ 715005233</span> -Can-Am Red | <b>\$149.99</b> |
|---------------------------|---|---|-----------------|



- Offers a solid place to hook on in case towing is needed.
- Allows you to attach most straps and hooks.
- "S3 for Can-Am" branded.

# LINQ EASY ON, EASY OFF CARGO



## MAVERICK'S LINQ ACCESSORIES

### Mounting location and requirements

|  |   |  |  |  |
|--|---|--|--|--|
| <ul style="list-style-type: none"> <li>•No tools needed: Quickly install and remove accessories by hand</li> <li>•Equip your Can-Am for specialized tasks in no time</li> <li>•Sturdy mounting system that holds up to the roughest terrain</li> </ul> |   | Standard Cargo Bed   | LinQ Pivoting Rack<br>715008295 /715008296 | Adventure Roof Rack<br>715003868 /715006225          |
| <b>LinQ Accessories with 16" Base</b>  |   | <ul style="list-style-type: none"> <li>•LinQ anchors mounted 16 inches apart, center-to-center.</li> <li>•Lower loading capacity than the LinQ with 36" base accessories.</li> <li>•Can be used on Can-Am ATV and SxS vehicles, Can-Am Spyder and Ryk Sea-Doo watercraft and Ski-Doo snowmobiles.</li> </ul> |  |  |
| LinQ 4.2 Gal Cooler<br>295100698 White<br>219400964 Black  |   |  |  | LinQ Base Installation Kit<br>715008125              |
| LinQ Tool Kit<br>715006829   |   |  |  | No further requirements                              |
| LinQ Tool Box<br>715008111   |   |  |  |  |
| LinQ SR 5.5 Gal (21 L) Bag<br>860202449  | LinQ Anchor Adapter Kit<br>715004960                    | LinQ Anchor Adapter Kit<br>715004960   |  | LinQ Base Installation Kit<br>715008125              |
| LinQ 4.5 Gal (17 L) Sport Bag<br>860202447   |   |  |  |  |
| LinQ Modular Box<br>715005494 (10 L)<br>715007112 (20 L)<br>715006830 (30 L)   |   |  |  | No further requirements                              |
| LinQ Roll-Top Bag<br>715008110   |   |  |  | LinQ Base Installation Kit<br>715008125              |
| <b>LinQ Accessories with 36" Base</b>  |   | <ul style="list-style-type: none"> <li>•Mount on LinQ racks often used by Can-Am ORV vehicles.</li> <li>•Higher loading capacity than the LinQ with 16" base accessories.</li> <li>•Usage is limited to Can-Am ORV vehicles.</li> </ul>  |  |  |
| LinQ 12 Gal (45 L) Cargo Box<br>715003879  | No compatibility  |  |  |  |
| LinQ 23 Gal (86 L) Trunk Box<br>715004923  | No further requirements                                 |  |  |  |
| LinQ 32 Gal (121 L) Trunk Box<br>715001748   | *Not compatible if the LinQ Pivoting Rack is installed. |  |  |  |
| LinQ 11.5 Gal (43 L) Audio Cargo Box<br>715003018  | No further requirements                                 | No further requirements  |  | No compatibility                                     |
| LinQ 8 Gal (30 L) Cooler Box<br>715004778 Black<br>715004698 Gray  |   |  |  |  |
| LinQ Premium Storage Bag<br>715002923 Black  | No further requirements                                 |  |  |  |
| LinQ Heavy Duty Basket<br>715001215  | No further requirements                                 |  |  |  |
| LinQ Low Profile Basket<br>715004282   |   |  |  |  |
| <b>LinQ Holders</b>  |   |  |  |  |
| LinQ Gear Grips<br>715005340   | No further requirements                                 | No further requirements  |  | Side wall installation<br>LinQ Adapters<br>715003058 |
| LinQ Tool Holder<br>715007358  |   |  |  |  |

## LinQ Accessories with 16" Base

|                         |                                 |                    |          |
|-------------------------|---------------------------------|--------------------|----------|
| <b>LinQ Modular Box</b> | M averick X3, M averick X3 M AX | 715005494 · (10 L) | \$139.99 |
|                         |                                 | 715007112 · (20 L) | \$159.99 |
|                         |                                 | 715006830 · (30 L) | \$179.99 |



- Allows stacking of other modular boxes to always have the right gear accessible.
- Always have the right box size to fit everything.
- Can be installed on any LinQ base with a 16" width.
- See table for installation location and requirements.

|   |                                 |           |         |
|---|---------------------------------|-----------|---------|
| <b>Thermal Insert for LinQ Modular Box (10 L)</b> | M averick X3, M averick X3 M AX | 219401110 | \$55.99 |
|---|---------------------------------|-----------|---------|



- Insulated liner.
- Fits very well in the LinQ Modular Box (10 L).
- Can contain seven 355 mL cans.
- Keeps ice cold for one day.
- Interior dimensions: 9" L x 17" W x 2 1/8" H.

|                      |                                 |           |          |
|----------------------|---------------------------------|-----------|----------|
| <b>LinQ Tool Box</b> | M averick X3, M averick X3 M AX | 715008111 | \$174.99 |
|----------------------|---------------------------------|-----------|----------|



- High precision injected HDPE construction provides rigidity and durability.
- 5 gal (19 L) maximum capacity.
- Weather-resistant, sealed and lockable cover.
- Easy one-second on/off tool-less system.
- All the benefits of LinQ – simple, fast and secure.
- See table for installation location and requirements.

|                      |                                 |           |          |
|----------------------|---------------------------------|-----------|----------|
| <b>LinQ Tool Kit</b> | M averick X3, M averick X3 M AX | 715006829 | \$309.99 |
|----------------------|---------------------------------|-----------|----------|



- Includes:
  - Cutter pliers
  - Long-nose pliers
  - Locking pliers
  - Ratchet wrench 1/2" drive
  - 6" ratchet extension
  - Integrated CVT belt storage location (belt not included)
  - Long-socket 19 mm 1/2" drive - 6 pts
  - Socket 18 mm 1/2" drive
  - Long-socket 17 mm 1/2" drive - 6 pts
  - Socket 15 mm 1/2" drive
  - Socket 13 mm 1/2" drive
  - Socket 10 mm 1/2" drive
  - Socket 8 mm 1/2" drive
  - Combined wrench 19 mm
  - Combined wrench 18 mm
  - Combined wrench 15 mm
  - Combined wrench 13 mm
  - Combined wrench 10 mm
  - Combined wrench 8 mm
  - Socket Torx T30 1/2" drive
  - Socket Torx T20 1/2" drive
  - Breaker bar 1/2" drive
  - See table for installation location and requirements

|                                   |                                 |  |          |
|-----------------------------------|---------------------------------|--|----------|
| <b>LinQ 4.2 Gal (16 L) Cooler</b> | M averick X3, M averick X3 M AX | ■ 219400964 · Black<br>■ 295100698 · White | \$369.99 |
|-----------------------------------|---------------------------------|--|----------|



- All the benefits of LinQ – simple, fast and secure.
- Rotomolded construction for exceptional rigidity and durability.
- Premium-quality foam insulation for optimal ice retention.
- Uses LinQ mounting system (Patent US 8777531 and US 8875830).
- Easy one-second on/off tool-less system.
- Can contain twenty 355 mL cans.
- Keeps ice cold for three days.
- Exterior dimensions: 13" L x 20" W x 10" H.
- Interior dimensions: 9" L x 17" W x 7" H.
- See table for installation location and requirements.

|                                      |                                 |           |          |
|--------------------------------------|---------------------------------|-----------|----------|
| <b>LinQ 4.5 Gal (17 L) Sport Bag</b> | M averick X3, M averick X3 M AX | 860202447 | \$204.99 |
|--------------------------------------|---------------------------------|-----------|----------|



- 17-liter (4.5 US gallon, 1,037 cu. in.) capacity.
- Rigid bottom, semi-rigid top.
- See table for installation location and requirements.

|                                   |                                 |           |          |
|-----------------------------------|---------------------------------|-----------|----------|
| <b>SR 5.5 Gal (21 L) LinQ Bag</b> | M averick X3, M averick X3 M AX | 860202449 | \$224.99 |
|-----------------------------------|---------------------------------|-----------|----------|



- All the benefits of LinQ – simple, fast and secure.
- Semi-rigid expandable bag.
- 5.5 gal (21 L) capacity.
- Utilizes LinQ mounting system (Patent US 8777531 and US 8875830).
- Easy one-second on/off tool-less system.
- See table for installation location and requirements.



|                          |                              |           |          |
|--------------------------|------------------------------|-----------|----------|
| <b>LinQ Roll-Top Bag</b> | Maverick X3, Maverick X3 MAX | 715008110 | \$229.99 |
|--------------------------|------------------------------|-----------|----------|



- Fully waterproof roll-top dry bag will securely store and confine your equipment.
- LinQ mounted using heavy-duty rigid plastic base.
- High capacity storage solution (40 L).
- Bottom foam liner for additional equipment protection.
- Integrated handle for easy transportation on/off the vehicle.
- Dimensions: 14"L x 19"W x adjustable H.
- See table for installation location and requirements.

## LinQ Accessories with 36" Base

|                                     |                              |           |          |
|-------------------------------------|------------------------------|-----------|----------|
| <b>LinQ 12 Gal (45 L) Cargo Box</b> | Maverick X3, Maverick X3 MAX | 715003879 | \$319.99 |
|-------------------------------------|------------------------------|-----------|----------|



- LinQ mounted for easy-on, easy-off installation.
- Holds cargo safely and securely while riding.
- See table for installation location and requirements.

|                                     |   |           |          |
|-------------------------------------|---|-----------|----------|
| <b>LinQ 23 Gal (86 L) Trunk Box</b> | Maverick X3 (except X3 trim models),<br>Maverick X3 MAX | 715004923 | \$369.99 |
|-------------------------------------|---|-----------|----------|



- LinQ mounted for easy-on, easy-off installation.
- Holds cargo safely and securely while riding.
- See table for installation location and requirements.

|                                      |   |                                |          |
|--------------------------------------|---|--------------------------------|----------|
| <b>LinQ 32 Gal (121 L) Trunk Box</b> | Maverick X3 (except X3 trim models),<br>Maverick X3 MAX | 715001748 · No rear tail light | \$489.99 |
|--------------------------------------|---|--------------------------------|----------|



- Equipped with the LinQ system, the rear trunk box plugs in and out in seconds.
- 32 gal (121 L) load capacity with unobstructed space to maximize storage room and access to the trunk's interior.
- Made of injection-molded polyethylene, double-walled in critical areas.
- The fully sealed lid protects your belongings from dust, moisture and the elements.
- No rear tail light.
- Trunk Box Panels available in many colors to match your vehicle (sold separately).
- See table for installation location and requirements.

|   |  |  |         |
|---|--|--|---------|
| <b>LinQ 32 Gal (121 L) Trunk Box Panels</b> | Fits with LinQ 32 Gal (121 L) Trunk Box<br>EUROPEAN VERSION (EC compliant) |  | \$59.99 |
|---|--|--|---------|



- Color panels to match the LinQ 32 gal (121 L) Trunk Box to your vehicle.
- No rear tail light

- 715001397 · Black
- 715001398 · Yellow
- 715002483 · White
- 715006121 · Can-Am Red

- 715006122 · Montana Green
- 715006123 · Orange Crush
- 715006124 · Viper Red

|                                     |                              |   |          |
|-------------------------------------|------------------------------|---|----------|
| <b>LinQ 8 Gal (30 L) Cooler Box</b> | Maverick X3, Maverick X3 MAX | ■ 715004778 · Black<br>■ 715004698 · Gray | \$439.99 |
|-------------------------------------|------------------------------|---|----------|



- LinQ mounted for easy-on, easy-off installation.
- Rotomolded construction provides exceptional rigidity and durability.
- Premium-quality foam insulation for optimal ice retention.
- Integrated, fully removable compartment protects food.
- Robust rubber latches keep the cover tightly closed.
- Weather-resistant.
- Convenient drain plug.
- See table for installation location and requirements.

|   |                              |           |          |
|---|------------------------------|-----------|----------|
| <b>LinQ 11.5 Gal (43 L) Audio Cargo Box</b> | Maverick X3, Maverick X3 MAX | 715003018 | \$759.99 |
|---|------------------------------|-----------|----------|



- An affordable and quick solution for adding music and storage to your next ride.
- The rear installation does not use up any cab space and allows easy listening at an average speed.
- Mounts on/off easily to hold/carry cargo safely and securely.
- Backlit control panel perfect for night riding.
- Water-resistant speakers.
- The Bluetooth-enabled receiver and 6.5" (16.5 cm) speakers are smartly concealed and integrated in the cover.
- Automatic shut-off function protects your battery by turning the system off after 10 minutes of inactivity.
- See table for installation location and requirements.

|                               |                              |           |          |
|-------------------------------|------------------------------|-----------|----------|
| <b>LinQ Heavy-Duty Basket</b> | Maverick X3, Maverick X3 MAX | 715001215 | \$269.99 |
|-------------------------------|------------------------------|-----------|----------|



- Made of high-strength, low-alloy steel.
- LinQ mount for easy-on, easy-off installation.
- See table for installation location and requirements.

|   |                              |                  |          |
|---|------------------------------|------------------|----------|
| <b>LinQ Premium Storage Bag by OGIO</b> | Maverick X3, Maverick X3 MAX | 715002923 - Back | \$439.99 |
|---|------------------------------|------------------|----------|



- Tool-less installation and removal thanks to the LinQ system.
- 17.2 gal (65 L) capacity semi-rigid cargo bag ideal for carrying anything you need on your vehicle.
- Buckle and elastic closure with a rubber seal that protects dust from entering the bag.
- 3-section lid for partial or full access to your bag.
- Inside separators for optimal bag organization.
- See table for installation location and requirements.

|                                |                              |           |          |
|--------------------------------|------------------------------|-----------|----------|
| <b>LinQ Low Profile Basket</b> | Maverick X3, Maverick X3 MAX | 715004282 | \$209.99 |
|--------------------------------|------------------------------|-----------|----------|



- Low profile, open basket increases cargo space.
- Perfect for easy access to tools, rope, winch and other accessories.
- Multiple bungee cord and tie-down anchor points.
- Made of impact-resistant injected polypropylene.
- See table for installation location and requirements.

## LinQ Holders

|                         |                              |           |         |
|-------------------------|------------------------------|-----------|---------|
| <b>LinQ Tool Holder</b> | Maverick X3, Maverick X3 MAX | 715007358 | \$54.99 |
|-------------------------|------------------------------|-----------|---------|



- Ultra-versatile tool holder.
- Convenient swivel latch allows tools to be stored in any orientation.
- Sold in pairs.

|                        |                              |           |          |
|------------------------|------------------------------|-----------|----------|
| <b>LinQ Gear Grips</b> | Maverick X3, Maverick X3 MAX | 715005340 | \$144.99 |
|------------------------|------------------------------|-----------|----------|



- Durable and flexible grips provide a custom fit for a variety of items from 1" to 4" (2.5 cm to 10 cm) in diameter.
- Heavy-duty design for carrying bows, fishing poles, rakes, farm tools and more.
- Quick-release button opens grip quickly for easy access to gear.
- Heavy-duty base system built for the toughest adventures.
- Make transporting your tools a snap by combining the LinQ Gear Grips with the LinQ system.
- 360° orientation.
- Sold in pairs.

## LinQ Mounting

|                                |                              |           |         |
|--------------------------------|------------------------------|-----------|---------|
| <b>LinQ Anchor Adapter Kit</b> | Maverick X3, Maverick X3 MAX | 715004960 | \$75.99 |
|--------------------------------|------------------------------|-----------|---------|



- Allows the installation of LinQ accessories with 16" base on LinQ racks.
- Tool-less installation and removal.

|                                   |                              |           |         |
|-----------------------------------|------------------------------|-----------|---------|
| <b>LinQ Base Installation Kit</b> | Maverick X3, Maverick X3 MAX | 715008125 | \$29.99 |
|-----------------------------------|------------------------------|-----------|---------|



- Allows installation of compatible LinQ accessories.
- Included: 2 LinQ Cargo bases and hardware.

|                          |                              |           |         |
|--------------------------|------------------------------|-----------|---------|
| <b>Tube LinQ Adapter</b> | Maverick X3, Maverick X3 MAX | 715004292 | \$31.99 |
|--------------------------|------------------------------|-----------|---------|



- Cage mounted LinQ receiver.
- Included in the LinQ Pivoting Rack assembly.
- Allows the installation of single LinQ mounted accessory.
- Diameter: 1.85" (47 mm).

|                  |                               |           |         |
|------------------|-------------------------------|-----------|---------|
| <b>LinQ Lock</b> | Maverick X3, Maverick X3 M AX | 860201968 | \$61.99 |
|------------------|-------------------------------|-----------|---------|



- Simple way to securely lock most LinQ accessories.
- Lock cover protects lock from the elements.
- Corrosion resistant.
- Pack of 1, includes 2 keys.
- Not compatible with LinQ 4.2 US Gal (16 L) Cooler, LinQ Toolbox, LinQ Tool Holder or LinQ Gear Grips.

|                              |                               |           |         |
|------------------------------|-------------------------------|-----------|---------|
| <b>LinQ Replacement Part</b> | Maverick X3, Maverick X3 M AX | 715001707 | \$27.99 |
|------------------------------|-------------------------------|-----------|---------|



- Unique mounting fastener usable on any LinQ system accessory.
- Toolless installation and removal.
- Sold in pairs.

|   |                  |           |         |
|---|------------------|-----------|---------|
| <b>LinQ Adapter</b><br><i>(Not illustrated)</i> | Maverick X3 M AX | 715003058 | \$34.99 |
|---|------------------|-----------|---------|

- Allows the installation of the LinQ Tool Holder on the Adventure Roof Rack.
- Sold in pack of 4.

|                      |                               |           |         |
|----------------------|-------------------------------|-----------|---------|
| <b>Cargo Box Net</b> | Maverick X3, Maverick X3 M AX | 715001371 | \$71.99 |
|----------------------|-------------------------------|-----------|---------|



- Solid net designed to secure and ensure the compact confinement of your Adventure Roof Rack.

|                                     |                               |           |         |
|-------------------------------------|-------------------------------|-----------|---------|
| <b>Spare Tire Ratchet Tie-Downs</b> | Maverick X3, Maverick X3 M AX | 280000955 | \$32.99 |
|-------------------------------------|-------------------------------|-----------|---------|



- 3-way ratcheting tie-down strap with loop ends.
- Designed to securely hold spare tires on accessories equipped with integrated spare tire attachment points.
- Adjustable to accommodate most common UTV tire sizes.
- Ratchet and junction ring made of durable zinc-plated steel.
- Required for spare tire attachment on Adventure Roof Rack.

# RACKS & STORAGE



## Racks

|                           |   |   |                                    |
|---------------------------|---|---|------------------------------------|
| <b>LinQ Pivoting Rack</b> | Maverick X3, Maverick X3 M AX<br>(except X3 models) | <b>715008295</b> - Black<br><b>715008296</b> - Can-Am Red | <b>\$589.99</b><br><b>\$649.99</b> |
|---------------------------|---|---|------------------------------------|



- LinQ latched rack allows for extra LinQ mounted accessories or for carrying a spare tire (tire not included).
- Includes custom tie-down strap for fast spare tire installation or removal (tire not included).
- Gas-cylinder pivot action, locks in the raised position.
- Trunk Boxes over 20 gal (74 L) do not fit on the vehicle when the rack is installed.
- Not compatible with Rear Intrusion Bars, Rear Cage Extension and Lonestar Racing Aluminum Roofs.

|                            |                  |           |          |
|----------------------------|------------------|-----------|----------|
| <b>Adventure Roof Rack</b> | Maverick X3      | 715006225 | \$679.99 |
|                            | Maverick X3 M AX | 715003868 | \$739.99 |



- Ideal cargo solution for packing everything you need to live your Off-Road experience fully and completely.
- Built with lightweight 1.25" (3.2 cm) diameter steel tubing.
- Integrated mounting points for lights can hold up to eight pod-type LED lights (six front and two back) or a 40" (102 cm) LED bar (front).
- Features anchor points for spare-tire attachment.
- LinQ anchor on both sides.
- Spare Tire Tie-Downs sold separately.
- Add the Cargo Box Net to secure and confine your cargo in the rack.
- Loads up to 75 lb (34 kg).

|                                |              |           |          |
|--------------------------------|--------------|-----------|----------|
| <b>NEW Adventure Roof Rack</b> | M averick X3 | 715007186 | \$719.99 |
|--------------------------------|--------------|-----------|----------|



- The ideal cargo solution. Pack all the gear you need to take on any off-road experience.
- Built using lightweight 1.25" (3.2 cm) diameter steel tubing.
- Supports loads of up to 75 lb (34 kg).
- This roof rack features a height adjustment setting to precisely accommodate a stock roof.
- Integrated mounting points for lights.
- Features anchor points for a spare tire attachment.
- LinQ anchor on both sides.
- The Spare Tire Tie-Downs sold separately.
- Sport roof for Aluminum roofs is required for installation.

## Storage

|                             |   |           |          |
|-----------------------------|---|-----------|----------|
| <b>Shoulder Storage Bag</b> | M averick X3 (except X3 m models),<br>M averick X3 M AX (rear only) | 715004277 | \$394.99 |
|-----------------------------|---|-----------|----------|



- Bag attaches in unused space between the seats to increase your vehicle's cargo capacity.
- Installs between the rear seats only on M AX models.

|                                   |                   |           |          |
|-----------------------------------|-------------------|-----------|----------|
| <b>Front Shoulder Storage Bag</b> | M averick X3 M AX | 715004888 | \$159.99 |
|-----------------------------------|-------------------|-----------|----------|



- Opens on each side so that both front and rear passengers can access the bag's content.
- Installs between the driver and passenger seats on M AX models.

|                             |                                 |           |          |
|-----------------------------|---------------------------------|-----------|----------|
| <b>Overhead Storage Bag</b> | M averick X3, M averick X3 M AX | 715004275 | \$119.99 |
|-----------------------------|---------------------------------|-----------|----------|



- Weather-resistant bag, holds your gear safely and securely while riding.
- Makes smart use of your overhead space to increase your vehicle's cargo capacity by 2.6 gal (10 L).
- Semi-rigid construction renders it flexible enough to fit odd-shaped loads.
- Touchscreen-compatible clear front pocket allows for easy access to your smartphone.
- Not compatible with the Bin in Roof.

|                                |                                 |           |          |
|--------------------------------|---------------------------------|-----------|----------|
| <b>Upper Door Storage Bags</b> | M averick X3, M averick X3 M AX | 715004276 | \$129.99 |
|--------------------------------|---------------------------------|-----------|----------|



- Weather-resistant, they'll hold your gear safely and securely while riding.
- Bags attach on stock quarter doors to increase your vehicle's cargo space.
- Each bag is designed as a 1.3 gal (6 L) capacity pocket also equipped with inner netting compartments.
- Semi-rigid construction renders them flexible enough to fit odd-shaped loads.
- Sold in pairs.

|                                      |                                 |           |          |
|--------------------------------------|---------------------------------|-----------|----------|
| <b>Lower Door Panel Storage Bags</b> | M averick X3, M averick X3 M AX | 715004355 | \$184.99 |
|--------------------------------------|---------------------------------|-----------|----------|



- Weather-resistant, they'll hold your gear safely and securely while riding.
- Bags attach on Lower Door Panels to increase your vehicle's cargo space.
- Each bag is designed as a 1.6 gal (6 L) capacity pocket also equipped with inner netting compartments.
- Semi-rigid construction renders them flexible enough to fit odd-shaped loads.
- Sold in pairs.
- Not compatible with aluminum doors and Off-Road Screw Jack.
- Lower add-on doors required for installation.

|                         |                                 |           |          |
|-------------------------|---------------------------------|-----------|----------|
| <b>Soft Storage Bag</b> | M averick X3, M averick X3 M AX | 715003759 | \$179.99 |
|-------------------------|---------------------------------|-----------|----------|



- 11.8 gal (45 L) capacity soft cargo bag designed with vehicle's rear in mind to maximize potential storage.
- 3 sections.
- Weatherproof.

|                                   |                                 |           |         |
|-----------------------------------|---------------------------------|-----------|---------|
| <b>Storage 2.6 Gal (10 L) Bag</b> | M averick X3, M averick X3 M AX | 269502121 | \$37.99 |
|-----------------------------------|---------------------------------|-----------|---------|



- Roll-top dry bag for fully protecting your cargo from the elements.



**NEW Passenger Storage Seat Bag**

Maverick X3, Maverick X3 MAX

715008080

\$249.99



- This weather-resistant bag holds your gear safely and securely while you ride.
- Bag setting on the passenger seat to increase the vehicle's cargo capacity.
- This bag features a 14.5 gal (5 L) storage capacity and is divided into two compartments.
- The top compartment is insulated to keep your beverages cold and includes two cup holders.
- Additional pocket inside for additional storage, such as a cellphone.
- The bottom compartment is accessible from both sides and serves as a large pocket for storing various items.
- The detachable pocket at the front of the bag can be used as a garbage bag.

# LIGHTS



|   |  | 2 Choose your lights                            |  |  |  |  |  |   |                                     |   |  |
|---|--|---|--|--|--|--|--|---|-------------------------------------|---|--|
| 1 Choose your mount point                       | BAJA DESIGNS LIGHTS                          |   |  |  |  | CAN-AM LIGHTS                                |  |   |                                     |   |  |
|   | 10" (25 cm) LED Light Bar                    | 40" (102 cm) Baja Design OnX6 Arc LED Light Bar | XL Sport LED Lights (sold in pairs)          | Squadron Sport LED Lights (sold in pairs)    | XL80 LED Lights (sold in pairs)              | 10" Double Stacked LED Bar                   | 15" Double Stacked LED Bar   | 39" Double Stacked LED Bar                          | 4" Round LED Lights (sold in pairs) | 3.5" Spot or Flood LED Lights (sold in pairs)   |  |
| Front Pre-Runner or Dune Bumpers                | 710006819<br>+<br>715007049<br>(Power Cable) | 710006818<br>+<br>715007117<br>(Power Cable)    | 710006821<br>+<br>715002884<br>(Power Cable) | 710006820<br>+<br>715002884<br>(Power Cable) | 710005041<br>+<br>715007049<br>(Power Cable) | 715002933<br>+<br>715003417<br>(Power Cable) | 715002934<br>(Not compatible with Pre-Runner Bum per)<br>+<br>715003417<br>(Power Cable) |   |                                     | 715002935 (4" Round),<br>715003665 (3.5" Flood) or<br>715003666 (3.5" Spot)<br>+<br>715003417 (Power Cable) |  |
| Lonestar Racing Front Bumper                    | NA   | 710006818<br>+<br>715007117<br>(Power Cable)    | 710006821<br>+<br>715002884<br>(Power Cable) | 710006820<br>+<br>715002884<br>(Power Cable) | 710005041<br>+<br>715007049<br>(Power Cable) |  |  |   |                                     | 715002935 (4" Round),<br>715003665 (3.5" Flood) or<br>715003666 (3.5" Spot)<br>+<br>715003417 (Power Cable) |  |
| Light Support Bar or Adventure Roof Rack        | 710006819<br>+<br>715007049<br>(Power Cable) | 710006818<br>+<br>715007117<br>(Power Cable)    | 710006821<br>+<br>715002884<br>(Power Cable) | 710006820<br>+<br>715002884<br>(Power Cable) | 710005041<br>+<br>715007049<br>(Power Cable) | 715002933<br>+<br>715003417<br>(Power Cable) | 715002934<br>+<br>715003417<br>(Power Cable)   | 715004007<br>+<br>715005822<br>(Light Mounting Kit) |                                     | 715002935 (4" Round),<br>715003665 (3.5" Flood) or<br>715003666 (3.5" Spot)<br>+<br>715003417 (Power Cable) |  |
| Lonestar Racing 40" (102 cm) LED Light Bar Rack | NA   | 710006818<br>+<br>715007117<br>(Power Cable)    | NA   | NA   | NA   | NA   | NA   | NA  | NA                                  | NA  |  |
| Lonestar Racing Light Rack                      | NA   | NA  | 710006821<br>+<br>715002884<br>(Power Cable) | NA   | 710005041<br>+<br>715007049<br>(Power Cable) | NA   | NA   | NA  | NA                                  | NA  |  |

**3 Order** **Order all part numbers in intersecting box**

\*Note: When installing more than one light kit, additional light power cable or mounting kit is required.

\*All lights are intended for off-road use only.

|   |                              |           |          |
|---|------------------------------|-----------|----------|
| <b>Lights Power Cable</b><br><i>(Not illustrated)</i> |                              | 715003417 | \$59.99  |
|   |                              | 715007049 | \$109.99 |
|   |                              | 715002884 | \$71.99  |
|   | Maverick X3, Maverick X3 MAX | 715007117 | \$104.99 |

- Required for installation of Baja Designs LED lights onto roof rack per.
- 10" (25 cm) Baja Designs OnX6 LED Bars and Baja Designs XL80 LED Lights (715007049).
- Baja Designs XL Sport LED Lights and Baja Designs Squadron Sport LED Lights (715002884).
- 40" (102 cm) Arc LED Light Bar OnX6 (715007117).

### 40" (102 cm) Baja Designs OnX6 Arc LED Light Bar

Maverick X3, Maverick X3 MAX

710006818

\$2,089.99



29,000 lumens

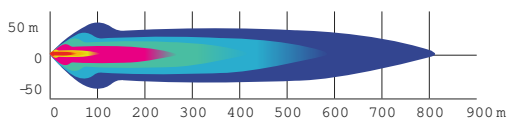

- 252 W light bar producing 29,000 lumens.
- Equipped with 24 Cree XM-L2 LEDs.
- Driving/combo light pattern for smooth blend of light for both near field applications and distance.

- Designed for installation onto Light Support Bar equipped roofs.
- Requires Light Power Cable and Light Support Bar.
- See table for installation location and requirements.

### Baja Designs 10" (25 cm) OnX6 LED Light Bar

Maverick X3, Maverick X3 MAX

710006819

\$549.99



12,460 lumens

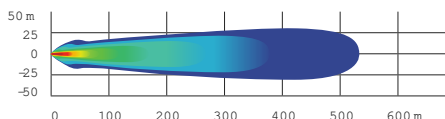

- 108 W light bar producing 12,460 lumens.
- Equipped with 6 Cree XM-L2 LEDs.
- Driving/combo light pattern for smooth blend of light for both near field applications and distance.

- Dual intensity (high/low) settings.
- Requires Baja Designs Light Power Cable.
- See table for installation location and requirements.

### Baja Designs XL80 LED Lights

Maverick X3, Maverick X3 MAX

710005041

\$1,039.99



9,500 lumens

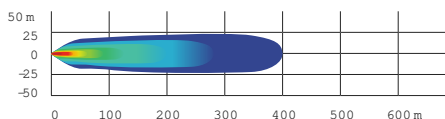

- 80 W per spot producing 9,500 lumens.
- Equipped with 4 Cree XHP50 LEDs per spot.
- Dual intensity (high/low) settings.
- Driving/combo light pattern for smooth blend of light for both near field applications and distance.

- Require Baja Designs Light Power Cable.
- Sold in pairs.
- Dimensions: 4.5" x 4.5" (11.4 cm x 11.4 cm).
- See table for installation location and requirements.

### Baja Designs Squadron Sport LED Lights

Maverick X3, Maverick X3 MAX

710006820

\$299.99



3,150 lumens

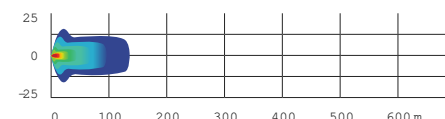

- 26 W per spot producing 3,150 lumens.
- Equipped with 4 Cree XP-G2 LEDs per spot.
- Wide cornering light pattern designed specifically for cornering, dust and/or fog conditions.

- Require Baja Designs Light Power Cable.
- Sold in pairs.
- Dimensions: 3" x 3" (7.6 cm x 7.6 cm).
- See table for installation location and requirements.

### Baja Designs XL Sport LED Lights

Maverick X3, Maverick X3 MAX

710006821

\$519.99



3,150 lumens

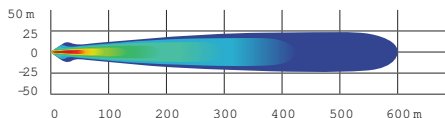

- 26 W per spot producing 3,150 lumens.
- Equipped with 4 Cree XP-G2 LEDs per spot.
- High Speed Spot features a longer and narrower beam focus for illumination farther down.

- Require Baja Designs Light Power Cable.
- Sold in pairs.
- Dimensions: 4.5" x 4.5" (11.4 cm x 11.4 cm).
- See table for installation location and requirements.

### 10" (25 cm) Double Stacked LED Light Bar (60 W)

Maverick X3, Maverick X3 M AX

715002933

\$369.99



5,400 lumens

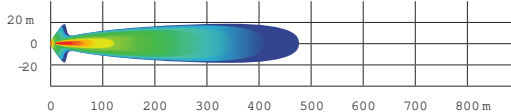

- Equipped with twelve 5 W Cree LEDs.
- 5,400 lumens.
- Packs a big punch for its size.
- Rugged and waterproof.
- Requires lightpower cable for installation.

- Lights up to more than 1,500 ft. (460 m) in front of the vehicle and around 65 ft. (20 m) wide on each side.
- EC compliant.
- See table for installation location and requirements.

### 15" (38 cm) Double Stacked LED Light Bar (90 W)

Maverick X3, Maverick X3 M AX

715002934

\$449.99



8,400 lumens

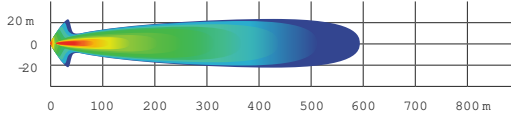

- Equipped with 18 5 W Cree LEDs.
- 8,400 lumens.
- Complements the LightRacks and most bumpers.
- Rugged and waterproof.

- Lights up to more than 1,900 ft. (580 m) in front of the vehicle and around 65 ft. (20 m) wide on each side.
- EC compliant.
- See table for installation location and requirements.

### 39" (99 cm) Double Stacked LED Light Bar (270 W)

Maverick X3, Maverick X3 M AX

715004007

\$879.99



24,300 lumens

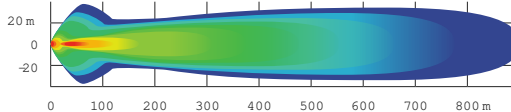

- Equipped with 54 5 W Cree LEDs.
- 24,300 lumens.
- Lights up to more than 2,900 ft. (900 m) in front of the vehicle and around 115 ft. (35 m) wide on each side.

- Compatible on the Adventure Roof Rack.
- Requires lightpower cable for installation.

### 4" (10 cm) Round LED Lights (2 x 25 W)

Maverick X3, Maverick X3 M AX

715002935

\$449.99



1,800 lumens

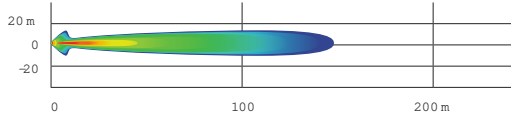

- 25 W LED spotlights.
- 1,800 lumens.

- Rugged and waterproof.
- Includes basic wiring and switch.

- Can-Am branded grill.
- Requires lightpower cable.
- Sold in pairs.

- Not EC compliant.
- Requires lightpower cable for installation.

### 3.5" (9 cm) LED Driving Lights (2 x 14 W)

Maverick X3, Maverick X3 M AX

715003666

\$254.99



1,260 lumens

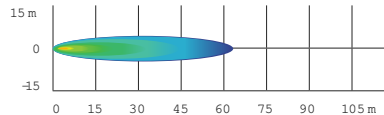

- 14 W LED lights producing 1,260 lumens each.
- Spotlights for a narrow and long light beam spread, ideal when driving at higher speeds.
- Equipped with six high-power LEDs in a heavy-duty die-cast aluminum housing.

- Features two attachment points. If one attachment point fails due to a collision, rotate to the next channel point and remove the light.
- Sold in pairs.
- EC compliant.
- Requires lightpower cable for installation.

|  |                                 |                  |                 |
|--|---------------------------------|------------------|-----------------|
| <b>3.5" (9 cm) LED Flood Lights (2 x 14 W)</b> | M averick X3, M averick X3 M AX | <b>715003665</b> | <b>\$254.99</b> |
|--|---------------------------------|------------------|-----------------|

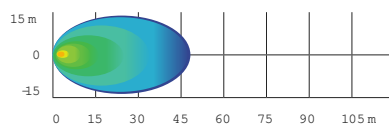

- 14 W LED lights producing 1,260 lumens each.
- Flood lens for a wide light beam spread, ideal for working applications like plowing or cornering. Suitable for dusty or foggy riding conditions.
- Equipped with six high-power LEDs in a heavy-duty die-cast aluminum housing.
- Features two attachment points. If one attachment point fails due to a collision, rotate to the next channel point and remove the light.
- Sold in pairs.
- EC compliant.
- Requires light power cable for installation.

|                                    |                                 |                  |                 |
|------------------------------------|---------------------------------|------------------|-----------------|
| <b>Can-Am LED Signature Lights</b> | M averick X3, M averick X3 M AX | <b>715003673</b> | <b>\$254.99</b> |
|------------------------------------|---------------------------------|------------------|-----------------|



- Add style with a more aggressive look.
- Use bright and energy efficient LEDs.
- Do not give additional lighting for driving.

|                   |                                 |                  |                |
|-------------------|---------------------------------|------------------|----------------|
| <b>Dome Light</b> | M averick X3, M averick X3 M AX | <b>715002455</b> | <b>\$84.99</b> |
|-------------------|---------------------------------|------------------|----------------|



- LED array integrates perfectly with vehicle.
- Wiring included.
- Can be installed on cage, Sport Roof or All Terrain Trunk Cover.

|  |                                 |                  |                 |
|--|---------------------------------|------------------|-----------------|
| <b>Lonestar Racing 40" (102 cm) LED Light Bar Rack</b> | M averick X3, M averick X3 M AX | <b>715003920</b> | <b>\$369.99</b> |
|--|---------------------------------|------------------|-----------------|



- Designed for use with 40" (102 cm) Baja Designs OnX6 Arc LED Light Bar.
- Enhances the vehicle's race-inspired look.
- Compatible with Aluminum Roof, Lonestar Racing Aluminum Roof and Sport Roof.
- Not compatible with Racing Side Mirrors and Power Flip Windshield.
- Lights sold separately.

|                                   |                                 |                  |                 |
|-----------------------------------|---------------------------------|------------------|-----------------|
| <b>Lonestar Racing Light Rack</b> | M averick X3, M averick X3 M AX | <b>715003948</b> | <b>\$369.99</b> |
|-----------------------------------|---------------------------------|------------------|-----------------|



- Designed for use with Baja Designs XL80 LED Light and Baja Designs XL Sport LED Light.
- Accommodates up to two pairs of XL Lights.
- Not compatible with Racing Side Mirrors and Power Flip Windshield.
- Compatible with Lonestar Racing Aluminum Roof, Aluminum Roof and Sport Roof.
- Lights sold separately.

|                     |                                 |                  |                 |
|---------------------|---------------------------------|------------------|-----------------|
| <b>Chase Lights</b> | M averick X3, M averick X3 M AX | <b>715002887</b> | <b>\$739.99</b> |
|---------------------|---------------------------------|------------------|-----------------|



- Designed by Can-Am to make you visible to vehicles riding behind you, especially in dusty or harsh conditions.
- Feature in-dash switches to activate one of the two modes and to choose among 11 different high-visibility colored light patterns (blue, red and yellow).
- Trail Mode: Serves as a tail light and as a brake light.
- Race Mode: Displays light patterns and serves as a brake light (brake light function can be deactivated for racing applications).
- Modular to allow installation with rear roll cage mounted accessories.
- Plug-and-play installation.

|                             |                                 |                  |                 |
|-----------------------------|---------------------------------|------------------|-----------------|
| <b>NEW LED Chase Lights</b> | M averick X3, M averick X3 M AX | <b>715009887</b> | <b>\$659.99</b> |
|-----------------------------|---------------------------------|------------------|-----------------|



- Designed by Can-Am to make you visible to vehicles riding behind you, especially in dusty or harsh conditions.
- High-visibility colored light patterns (red, yellow, white).
- Three modes available:
  - Trail Mode: serves as a tail light and as a brake light.
  - Chasing Mode: displays amber light pattern.
  - Work Mode: white light to light up your cargo bed.
- Modular to allow installation with rear roll cage mounted accessories.
- Plug-and-play installation.
- Wiring harness required (715008210).
- Sold separately.



|                          |                              |           |          |
|--------------------------|------------------------------|-----------|----------|
| <b>Light Support Bar</b> | Maverick X3, Maverick X3 MAX | 715003529 | \$254.99 |
|--------------------------|------------------------------|-----------|----------|



- Sleekly styled rugged aluminum construction.
- Accommodates lightbars and spotlights with or without any roof and windshield combination.
- Full vehicle width to allow the installation of any large LED lightbar.
- Required for light installation on vehicle's roof.
- Not compatible with Lonestar Racing Aluminum Roof.
- Lights sold separately.

|   |                              |           |          |
|---|------------------------------|-----------|----------|
| <b>Mounting Kit for 39" (99 cm) LED Light Bar</b><br><i>(Not illustrated)</i> | Maverick X3, Maverick X3 MAX | 715005822 | \$124.99 |
|---|------------------------------|-----------|----------|

- Required for installation of the 39" (99 cm) double stacked LED Light Bar.
- Includes wiring and support bracket.
- Light Support Bar required for installation.

|  |                              |           |         |
|--|------------------------------|-----------|---------|
| <b>Light Power Cable</b><br><i>(Not illustrated)</i> | Maverick X3, Maverick X3 MAX | 715003417 | \$59.99 |
|--|------------------------------|-----------|---------|

- Required for installation of 10" (25 cm), 15" (38 cm) and Double Stacked LED Light Bars and 4" (10 cm) Round LED Lights.
- For use in a variety of mounting locations.

|  |                              |           |          |
|--|------------------------------|-----------|----------|
| <b>NEW Integrated LED Side Mirror Lights</b> | Maverick X3, Maverick X3 MAX | 715007185 | \$319.99 |
|--|------------------------------|-----------|----------|



- Light up corners.
- Increase the width of the beams and illuminate the wheels for increased visibility.
- Wide flood beam.
- 3,000 lumens for each light.
- Require Aluminum Side Mirrors (715007363).
- Electric Harness (715008212) required to hook up and operate the Integrated LED Side Mirror Lights (715007185) for on/off function when ACM is not installed.
- Wiring Harness (715008212) is required for installation.

# AUDIO & COMMUNICATION SYSTEMS



## Audio

|                          |             |           |            |
|--------------------------|-------------|-----------|------------|
| <b>Can-Am Audio Roof</b> | Maverick X3 | 715007130 | \$3,299.99 |
|--------------------------|-------------|-----------|------------|



- Full roof with sleek built-in audio.
- Fully sealed and waterproof.
- Easy to install, one wire connects the roof to the vehicle's electronics.
- Four 8" speakers, one 400 RMS and 800 peak watt amp, and one Head Unit supplied by Rockford Fosgate Audio.
- Multi-colored RGB LED accent lighting around each speaker.
- 2.7" color display with Bluetooth and Pandora connectivity.
- Flip Kit compatible.
- Not compatible with the Adventure Roof Rack if the Flip Kit is installed.
- Not compatible with the Upper Soft Door Panels.

|                          |                 |           |            |
|--------------------------|-----------------|-----------|------------|
| <b>Can-Am Audio Roof</b> | Maverick X3 MAX | 715006709 | \$4,599.99 |
|--------------------------|-----------------|-----------|------------|



- Full roof with built-in audio.
- Fully sealed and waterproof.
- Easy to install, one wire connects the roof to the vehicle's electric system.
- Six 8" speakers, one 400 RMS and 800 peak watt amp, and one Head Unit calibrated by Rockford Fosgate Audio.
- Multi-colored RGB LED accent lighting around each speaker.
- 2.7" color display with Bluetooth and Pandora connectivity.
- Not compatible with the Adventure Roof Rack if the Flip Kit is installed.
- Not compatible with the Upper Soft Door Panels.

|                                   |                              |           |          |
|-----------------------------------|------------------------------|-----------|----------|
| <b>Can-Am Audio Roof Flip Kit</b> | Maverick X3, Maverick X3 MAX | 715007131 | \$459.99 |
|-----------------------------------|------------------------------|-----------|----------|





- Combines with Audio Roof (715007130 or 715006709) for Flip option.
- Not compatible with the Racing Side Mirrors (715002898).

|                             |                 |           |          |
|-----------------------------|-----------------|-----------|----------|
| <b>MTX Central Speakers</b> | Maverick X3 MAX | 715004748 | \$829.99 |
|-----------------------------|-----------------|-----------|----------|



- Top mounted central speaker case holding two 6.5" (16.5 cm) / 100W speakers.
- Designed to be Can-Am tough in the most demanding riding conditions.
- Perfect add-on to the Complete MTX Audio System for a 7-speaker system or as a stand-alone system by plugging the AUX input jack directly into your music device.
- Not compatible with Lonestar roofs.

|   |  |  |            |
|---|--|--|------------|
| <b>Complete MTX Audio System</b>  | Maverick X3, Maverick X3 MAX   | 715002873  | \$1,499.99 |
|  | <ul style="list-style-type: none"> <li>Bluetooth 5.1 equipped 400 W RMS/800 W peak audio system by MTX.</li> <li>Designed to be Can-Am-tough in the most demanding riding conditions.</li> </ul> | <ul style="list-style-type: none"> <li>Includes front-dash-board and rear roll-over cage mounted stereo speakers and head unit with an integrated 6.5" (16.5 cm) subwoofer.</li> <li>Add the Electronic Device Holder to securely hold your Bluetooth device ready to play your favorite tunes.</li> </ul> |            |

|   |   |  |          |
|---|---|--|----------|
| <b>Can-Am Subwoofer</b>   | Maverick X3, Maverick X3 MAX  | 715004956  | \$589.99 |
|  | <ul style="list-style-type: none"> <li>Powerful Rockford Fosgate Underseat 10" Subwoofer speakerbox.</li> <li>Easy plug-and-play connections to Audio Roof system.</li> <li>Sturdy construction tough enough to withstand harsh environments and sealed against moisture and dirt.</li> </ul> | <ul style="list-style-type: none"> <li>Requires 1 Amplifier Kit (715007227) for 1 or 2 subwoofers.</li> <li>Fits two per vehicle: under driver or passenger seat.</li> <li>Wiring included.</li> </ul> |          |

|   |  |           |          |
|---|--|-----------|----------|
| <b>Can-Am Amplifier Kit</b>   | Maverick X3, Maverick X3 MAX   | 715007227 | \$599.99 |
|  | <ul style="list-style-type: none"> <li>A powerful 1400 W amplifier to feed up to two Underseat Subwoofers.</li> <li>Easy plug-and-play connections to Audio Roof system and subwoofer.</li> <li>Installation plate and wiring included.</li> </ul> |           |          |

|  |   |   |         |
|--|---|---|---------|
| <b>Electronic Device Holder</b>  | Maverick X3, Maverick X3 MAX  | 715002874   | \$99.99 |
|  | <ul style="list-style-type: none"> <li>A great in-ride entertainment system platform.</li> <li>Robust injected polypropylene construction allows for right fit and easy installation.</li> <li>Adjustable unit safely holds most tablets and smartphones measuring between 5.1" (13 cm) and 10" (25.4 cm) with protective case).</li> </ul> | <ul style="list-style-type: none"> <li>Combines seamlessly with Complete MTX Audio System and Rugged Radios Intercom System.</li> <li>Allows the installation of Garmin Montana 680T GPS.</li> <li>Integrated storage (1 gal [3.8 L] capacity) with access to the dash 12V outlet for device charging.</li> </ul> |         |

## Communication Systems

|   |   |                     |          |
|---|---|---------------------|----------|
| <b>Rugged Radios Helmet Headset Kit for Rear Passengers</b>                         | With Rugged Radios Intercom System  | 715004380 - US ONLY | \$229.99 |
|  | <ul style="list-style-type: none"> <li>Additional 12' (3.7 m) cables and Helmet Speaker/Mic Kits to upgrade your 2-person intercom system to a 4-person system.</li> <li>Power Cable is required for installation on MAX models.</li> </ul> |                     |          |

# ELECTRICAL & ELECTRONIC ACCESSORIES



## Electrical

|   |  |           |          |
|---|--|-----------|----------|
| <b>Seat Heater</b>  | Maverick X3, Maverick X3 MAX   | 715006112 | \$139.99 |
|  | <ul style="list-style-type: none"> <li>25 W seat heater delivers chill-free riding comfort.</li> <li>High/low temperature settings allow you to control the desired degree of warmth.</li> <li>This kit includes one carbon fiber seat heater, foam sheet and in-dash switch.</li> <li>Installs directly in the original seat cushion.</li> <li>Heated Accessories Wiring Harness (710005757) is required for front seat installation.</li> <li>Heated Accessories Wiring Harness (715006004) is required for rear seat installation.</li> </ul> |           |          |

|  |   |           |         |
|--|---|-----------|---------|
| <b>Heated Visor Outlet</b>   | Maverick X3, Maverick X3 MAX  | 715001246 | \$56.99 |
|  | <ul style="list-style-type: none"> <li>Strategically positioned on vehicle to maintain your agility.</li> <li>Optional visor outlet that delivers fog-free riding.</li> <li>Quick and easy installation.</li> <li>Sold individually.</li> <li>Heated Visor not included.</li> </ul> |           |         |

## Heated Accessories Wiring Harness

(Not illustrated)

Maverick X3, Maverick X3 MAX

710005757

\$119.99

- Electric harness required to hook up and operate front heated seats, heated steering wheel and heated grab bar.
- Heated Accessories Wiring Harness (715006004) is required for rear seat installation.

## Auxiliary Battery Installation Kit

(Not illustrated)

Maverick X3, Maverick X3 MAX

715006315

\$299.99

- Allows you to add a second 18Ah battery for a dual battery setup necessary to power auxiliary electrical components such as sound systems or winches.
- Equipped with an IP67-rated waterproof electronic module that will prevent your auxiliary electrical components from draining your starting battery.
- Kit includes an additional battery junction block, all necessary wiring and the battery holder.
- Both batteries are perfectly integrated, in stock location, behind the passenger seat.
- Additional battery (#10301203), plus battery hardware (#250000282) sold separately.

## Electronic

### NEW Cellphone Holder

Maverick X3, Maverick X3 MAX

715008786

\$99.99



- Water resistant door allows for perfect phone positioning.
- Features capacitive and resistive touch screen technology.
- Spring system in back plate automatically adjusts for thickness.
- Fits all cellphones within 7.2" (185 mm) x 3.3" (85 mm) x 0.6" (15 mm) dimensions.
- Works with almost all charger wires.
- Does not include cellphone or charging wires.
- Requires the Electronic Device Holder (715002874) for the Cellphone Holder to be bolted on its door.

### Lighted Whip Flag

Maverick X3, Maverick X3 MAX

715002886

\$309.99



- A must for riding the dunes.
- 5 W Cree LED.
- 5 colored lenses to allow personalization.
- Glow-through whip, quickly removable and replaceable pole.
- Increases vehicle's visibility.
- Meets most dune-area requirements.
- Die cast aluminum base, acetabular nut.
- Includes mounting brackets and wiring.
- 4' (1.2 m) flag mounts on top of the roll cage.
- Can be installed on both sides of a vehicle.

### Quick Connect Battery Cable

715005408

\$10.49



- Quickly and easily connect and charge different batteries with your charger.
- Included in the Battery Charger/Maintainer.
- Sold individually.

### Quick Connect Cable with Battery Indicator

715006055

\$22.49



- Quickly and easily connect and charge different batteries with your charger.
- 3-color LED indicator provides constant battery health indication.
- Sold individually.

### Digitally Encoded Security System (D.E.S.S.) Green Key

Maverick X3  
(Turbo/TurboR/TurboRR motorization)

710005232

\$53.99



- Top-security anti-theft protection for your vehicle.
- Encrypted chip technology restricts access to your vehicle's electronic ignition system.
- One vehicle/one code.
- A vibration/shock-resistant ball-and-socket design that ensures a reliable connection.
- 3 programmable modes:
  - Work mode: Limits vehicle speed to 40 kph (25 mph) but does not limit engine torque.
  - Normal mode: Limits vehicle speed to 70 kph (44 mph) and 50% torque reduction.
  - Performance mode: No restrictions.

# WINCHES & HITCHES



## Can-Am HD Winches

|                             |                              |                  |                 |
|-----------------------------|------------------------------|------------------|-----------------|
| <b>Can-Am HD 4500 Winch</b> | Maverick X3, Maverick X3 MAX | <b>715006416</b> | <b>\$359.99</b> |
|-----------------------------|------------------------------|------------------|-----------------|



- Ergonomic clutch handle.
- Rugged all-steel gears and bushings form ore torque and durability.
- Automatic 100% load-holding brake.
- Sealed solenoid for all-weather protection.
- Weathersealed corded remote and dash mounted switch.

- EC compliant.
- Pulling strength capability of 4,500 lb (2,041 kg).
- 43' of 1/2" (13.1 m of 6.3 mm) wire steel cable.
- Heavy-duty 4-way roller fairlead.
- Winch Electrical Harness (715003585) and winch compatible front bumper are required.

|                               |                              |                  |                 |
|-------------------------------|------------------------------|------------------|-----------------|
| <b>Can-Am HD 4500-S Winch</b> | Maverick X3, Maverick X3 MAX | <b>715006417</b> | <b>\$479.99</b> |
|-------------------------------|------------------------------|------------------|-----------------|



- Ergonomic clutch handle.
- Rugged all-steel gears and bushings form ore torque and durability.
- Automatic 100% load-holding brake.
- Sealed solenoid for all-weather protection.
- Weather-sealed corded remote and dash mounted switch.

- Pulling strength capability of 4,500 lb (2,041 kg).
- 50' of 1/2" (15.2 m of 6.35 mm) synthetic rope.
- Corrosion-proof aluminum hawse fairlead.
- Winch Electrical Harness (715003585) and winch compatible front bumper are required.

## WARN<sup>†</sup> VRX Winches

|                          |                              |                  |                 |
|--------------------------|------------------------------|------------------|-----------------|
| <b>WARN VRX 45 Winch</b> | Maverick X3, Maverick X3 MAX | <b>715006110</b> | <b>\$609.99</b> |
|--------------------------|------------------------------|------------------|-----------------|



- Extreme IP68-rated waterproof sealing keeps the elements out.
- Durable aluminum construction.
- Black powder-coated finish and stainless steel fasteners for corrosion resistance.
- Robust new clutch design based on 70+ years of WARN 4WD hub lock know-how.
- Load-holding brake for great control.
- Smooth and reliable aluminum three-stage planetary geartrain.

- Dash-mounted rocker control.
- Limited lifetime warranty (mechanical), 3-year warranty (electrical).
- Pulling strength capability of 4,500 lb (2,041 kg).
- 50' of 1/2" (15 m of 6.3 mm) wire steel cable.
- Roller fairlead.
- Winch Electrical Harness (715003585) and winch compatible front bumper are required.

|                            |                              |                  |                 |
|----------------------------|------------------------------|------------------|-----------------|
| <b>WARN VRX 45-S Winch</b> | Maverick X3, Maverick X3 MAX | <b>715006111</b> | <b>\$729.99</b> |
|----------------------------|------------------------------|------------------|-----------------|



- Extreme IP68-rated waterproof sealing keeps the elements out.
- Durable aluminum construction.
- Black powder-coated finish and stainless steel fasteners for corrosion resistance.
- Robust new clutch design based on 70+ years of WARN 4WD hub lock know-how.
- Load-holding brake for great control.
- Smooth and reliable aluminum three-stage planetary geartrain.

- Dash-mounted rocker control.
- Limited lifetime warranty (mechanical), 3-year warranty (electrical).
- Pulling strength capability of 4,500 lb (2,041 kg).
- 50' of 1/2" (15 m of 6.3 mm) synthetic rope.
- Cast aluminum hawse fairlead.
- Winch Electrical Harness (715003585) and winch compatible front bumper are required.

## Winch Accessories

|                                 |                 |                  |                |
|---------------------------------|-----------------|------------------|----------------|
| <b>Can-Am HD Hawse Fairlead</b> | Can-Am HD Winch | <b>715006426</b> | <b>\$57.99</b> |
|---------------------------------|-----------------|------------------|----------------|



- A must when upgrading your winch with a synthetic cable, this corrosion-proof aluminum hawse fairlead will prevent the cable from snapping in a corner of a roller fairlead and from wearing prematurely due to the rough surface of the worn roller guide.
- Must be used with synthetic cables only.

|                            |            |                  |                 |
|----------------------------|------------|------------------|-----------------|
| <b>WARN Hawse Fairlead</b> | WARN Winch | <b>715007785</b> | <b>\$109.99</b> |
|----------------------------|------------|------------------|-----------------|



- Double-powder-coated construction.
- Required to use the Synthetic Winch Cable (715001118) on WARN winches.
- To be used with synthetic winch cables only.

|                              |                 |                  |                 |
|------------------------------|-----------------|------------------|-----------------|
| <b>Synthetic Winch Cable</b> | Can-Am HD Winch | <b>715006430</b> | <b>\$149.99</b> |
|                              | WARN Winch      | <b>715007783</b> | <b>\$164.99</b> |



- 50' of 1/2" (15.2 m of 6.35 mm) synthetic cable for Can-Am HD winches.
- Can-Am HD Hawse Fairlead (715006426) is required when upgrading to a synthetic cable to avoid premature cable damage and wear.
- WARN Hawse Fairlead (715007785) is required when upgrading to a synthetic cable to avoid damage and premature wear of the cable.



|                              |                 |                  |                |
|------------------------------|-----------------|------------------|----------------|
| <b>Wire Rope Replacement</b> | Can-Am HD Winch | <b>705014978</b> | <b>\$22.49</b> |
|                              | WARN Winch      | <b>715006699</b> | <b>\$80.99</b> |



- 43' of 1/2" (11.3 m of 6.3 mm) wire rope for Can-Am HD Winch.
- 55' of 3/8" (16.8 m of 6.35 mm) wire rope for WARN winch kit.
- 4,500 lb (2,041 kg) pulling strength.

|                                  |  |                  |                 |
|----------------------------------|--|------------------|-----------------|
| <b>Synthetic Cable Extension</b> |  | <b>715001120</b> | <b>\$169.99</b> |
|----------------------------------|--|------------------|-----------------|



- Lightweight 1/2" (6.35 mm) diameter, easy to handle and won't rattle in cargo box.
- Easily attaches to winch cable to provide additional 150' (45.2 m) of distance.
- 4,500 lb (2,041 kg) single line capacity.

|   |                              |                  |                 |
|---|------------------------------|------------------|-----------------|
| <b>Winch Electrical Harness</b><br><i>(Not illustrated)</i> | Maverick X3, Maverick X3 MAX | <b>715003585</b> | <b>\$109.99</b> |
|---|------------------------------|------------------|-----------------|

- Required for winch installation.

|   |  |                  |                 |
|---|--|------------------|-----------------|
| <b>Rear Winch Harness</b><br><i>(Not illustrated)</i> |  | <b>715006007</b> | <b>\$219.99</b> |
|---|--|------------------|-----------------|

- Required for installation of a winch on the S3 Rear Winch Bumper.

|                             |                  |                  |                |
|-----------------------------|------------------|------------------|----------------|
| <b>Wired Remote Control</b> | Can-Am HD Winch* | <b>715006504</b> | <b>\$24.99</b> |
|-----------------------------|------------------|------------------|----------------|



- This kit allows winch owners to add the hand-held remote to vehicles with a stock winch.
- OEM stock winch is sold separately.
- EC compliant.

† Harness (710001023) is required to use remote control on a vehicle with a factory installed winch.  
† Remote control (710007050) and connection socket are included.

|                                |            |                  |                 |
|--------------------------------|------------|------------------|-----------------|
| <b>Wireless Remote Control</b> | WARN Winch | <b>715002542</b> | <b>\$214.99</b> |
|--------------------------------|------------|------------------|-----------------|



- The system is quick and easy to install, thanks to a wiring harness with an integrated antenna and all necessary mounting hardware.
- The system allows you to operate your winch from anywhere within a 50' (15.2 m) radius, increasing your recovery options.
- All components are weatherproof.

|                                 |   |                  |                |
|---------------------------------|---|------------------|----------------|
| <b>X rc/ X mr Rear Tow Hook</b> | Maverick X3, Maverick X3 MAX 2021 & prior | <b>715004450</b> | <b>\$80.99</b> |
|---------------------------------|---|------------------|----------------|



- Offers a solid place to hook onto in case towing is needed.
- Allows you to attach most straps and hooks.
- Made of rugged 1/2" (6 mm) steel plate and 1/2" (16 mm) steel hook tube.
- Standard on Maverick X rc and X m models.

## Hitches

|                   |   |                        |                 |
|-------------------|---|------------------------|-----------------|
| <b>Rear Hitch</b> | Maverick X3, Maverick X3 MAX 2021 & prior | 715002883 - Black      | <b>\$229.99</b> |
|                   |   | 715003938 - Can-Am Red | <b>\$204.99</b> |



- Rugged lightweight steel construction.
- E-coated finish.
- Fixed mounting point for trailer ball to provide vehicle with towing capabilities.
- This hitch offers 1,300 lb (690 kg) of towing capacity.
- Hitch ball not included.

|                                     |                              |                  |                |
|-------------------------------------|------------------------------|------------------|----------------|
| <b>Front and Rear Hitch Drawbar</b> | Maverick X3, Maverick X3 MAX | <b>715008350</b> | <b>\$99.99</b> |
|-------------------------------------|------------------------------|------------------|----------------|



- Standard on 2" (6 cm) receiver hitch.
- It offers 1,650 lb (750 kg) of towing capacity.
- Hitch ball not included.
- Forged steel.

# PERFORMANCE

## Smart-Lok Technology

|                               |   |                  |                   |
|-------------------------------|---|------------------|-------------------|
| <b>Smart-Lok Differential</b> | Maverick X3 produced after January 1, 2017<br>Maverick X3 MAX | <b>705402936</b> | <b>\$1,679.99</b> |
|-------------------------------|---|------------------|-------------------|



- Can-Am exclusive Smart-Lok technology constitutes a true fully lockable on-the-fly front differential with electronically controlled automatic modes.
- Choose your differential settings according to your riding need: "2x4" for rear wheel traction only, "4x4 Front Diff Lock" for a fully locked 4 wheel drive, and "4x4 Smart Mode" that offers preset, intelligent calibrations for your type of riding.
- Using multiple input sources, "Smart Mode" will instantaneously engage locking with the right pad at the right moment to procure maximum traction while retaining low-speed maneuverability, allowing for optimal placement and a feeling of confidence.
- The Smart-Lok Differential Kit comes standard with the Trail Mode.
- Mud, Rock and Trail Active Modes can be added by installing an additional Smart Mode Module (sold separately) to fine-tune your riding environment.
- Requires Performance Half Shafts (2x) and Smart-Lok Installation Kit for installation.

|                               |                              |                       |                 |
|-------------------------------|------------------------------|-----------------------|-----------------|
| <b>Performance Half Shaft</b> | Maverick X3, Maverick X3 MAX | <b>705401634 -64"</b> | <b>\$259.99</b> |
|                               | Maverick X3, Maverick X3 MAX | <b>705402048 -72"</b> |                 |



- High-performance design ideal for off-road use, with superior protection in any riding usage.
- Includes CVs, shaft and boots with the best suited geometry for your Can-Am vehicle.
- Required to install the Smart-Lok Differential Kit.

|  |   |                  |                 |
|--|---|------------------|-----------------|
| <b>Mud Smart Mode Module</b><br><i>(Not illustrated)</i> | Maverick X3, Maverick X3 MAX with<br>Smart-Lok Differential<br>(except Turbo RR models 2021 & up) | <b>715005282</b> | <b>\$179.99</b> |
|--|---|------------------|-----------------|

- This module allows you to add the Mud Smart Mode to vehicles with the Smart-Lok Differential Kit sold as an accessory or to change to the Mud Smart Mode on vehicles equipped with a standard Smart-Lok.
- The Mud Mode has been specially designed to deliver superior traction in the deepest mud holes.
- When high engine torque and/or slippage is detected, Smart-Lok will fully lock the front end.
- The system will stay locked until throttle release.
- Only one Smart Mode Module can be installed at a time.

|   |   |                  |                 |
|---|---|------------------|-----------------|
| <b>Rock Smart Mode Module</b><br><i>(Not illustrated)</i> | Maverick X3, Maverick X3 MAX with<br>Smart-Lok Differential<br>(except Turbo RR models 2021 & up) | <b>715005283</b> | <b>\$179.99</b> |
|---|---|------------------|-----------------|

- This module allows you to add the Rock Smart Mode to vehicles with the Smart-Lok Differential Kit sold as an accessory or to change to the Rock Smart Mode on vehicles equipped with a standard Smart-Lok.
- The Rock Mode has been specially designed to help cross challenging rocks.
- When high engine torque is detected at low vehicle speed, Smart-Lok will progressively lock the front end and will stay engaged until throttle release to prevent wheel slippage and provide optimal traction.
- The progressive engagement allows for easier steering when maneuvering the vehicle.
- Only one Smart Mode Module can be installed at a time.

|   |   |                  |                 |
|---|---|------------------|-----------------|
| <b>Trail Active Smart Mode Module</b><br><i>(Not illustrated)</i> | Maverick X3, Maverick X3 MAX with<br>Smart-Lok Differential<br>(except Turbo RR models 2021 & up) | <b>715005284</b> | <b>\$179.99</b> |
|---|---|------------------|-----------------|

- This module allows you to add the Trail Active Smart Mode to vehicles with the Smart-Lok Differential Kit sold as an accessory or to change to the Trail Active Smart Mode on vehicles equipped with a standard Smart-Lok.
- The Trail Active Mode has been designed for aggressive riding, delivering the ultimate cornering precision.
- When high engine torque and/or an increase in vehicle speed is detected, Smart-Lok will progressively engage the front end and maintain it engaged until throttle release or vehicle speed reduction.
- The progressive engagement allows for smoother and lower steering effort.
- Only one Smart Mode Module can be installed at a time.

|  |                              |                  |                 |
|--|------------------------------|------------------|-----------------|
| <b>Lonestar Racing Mud Flaps with Brackets</b> | Maverick X3, Maverick X3 MAX | <b>715004865</b> | <b>\$309.99</b> |
|--|------------------------------|------------------|-----------------|



- These bolt-on mud flaps make a great addition.
- Durable chromoly brackets.
- Protect trailing arms, rotors and CVs from rocks and debris.
- Sold in pairs.

|  |                              |           |          |
|--|------------------------------|-----------|----------|
| <b>Lonestar Racing Heavy-Duty Shift Plate &amp; Knob</b> | Maverick X3, Maverick X3 MAX | 715004866 | \$159.99 |
|--|------------------------------|-----------|----------|



- The shift plate is made from durable stainless steel and bolts into place for a secure fit.
- The kit comes with a billet aluminum Lonestar Racing shift knob.
- Offers improved durability for the performance-oriented driver.

|   |   |           |          |
|---|---|-----------|----------|
| <b>Lonestar Racing Outer Toe Link Boxed Gussets Roller Fairlead</b> | Maverick X3, Maverick X3 MAX 2021 & prior | 715004868 | \$149.99 |
|---|---|-----------|----------|



- Protects and strengthens the middle radius rod links from rough riding conditions.
- Includes high-grade steel bolts.

|  |                              |           |          |
|--|------------------------------|-----------|----------|
| <b>Lonestar Racing Quick Release Clutch Cover Pins</b> | Maverick X3, Maverick X3 MAX | 715005045 | \$114.99 |
|--|------------------------------|-----------|----------|



- This kit will allow you to take off your clutch cover in seconds to access the belt toollessly.
- Includes 4 stainless steel "quick release" pins with clips and tethers.
- Replaces all clutch cover screws.
- This product affects the clutch cover sealing. It is highly recommended to use this product under dry riding conditions only.

|   |   |           |          |
|---|---|-----------|----------|
| <b>Lonestar Racing Heavy-Duty Rear Boxed Radius Rod Support Plate</b> | Maverick X3, Maverick X3 MAX 2021 & prior | 715005046 | \$239.99 |
|---|---|-----------|----------|

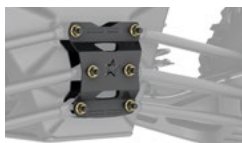

- Double-layered radius rod support plate made of high-grade steel.
- Reinforces your rod mounting location on the frame while adding a mean racing look to your vehicle.
- Easy to install.

|  |                              |           |            |
|--|------------------------------|-----------|------------|
| <b>Yoshimura<sup>†</sup> Slip-on Exhaust</b> | Maverick X3, Maverick X3 MAX | 715002882 | \$1,619.99 |
|--|------------------------------|-----------|------------|



- Developed in collaboration with Yoshimura.
- Made from 304-grade stainless steel with brushed aluminum tip.
- Better sounding, better looking and 19% lighter than stock muffler.
- USD F/USDA approved spark arrester.
- Fuel injection system tuning not required.
- ROHVA and EPA compliant.
- Not EC compliant.

|   |                              |           |          |
|---|------------------------------|-----------|----------|
| <b>Performance Air Filter by Twin AIR<sup>†</sup></b> | Maverick X3, Maverick X3 MAX | 715002895 | \$109.99 |
|---|------------------------------|-----------|----------|



- The best choice for the harshest conditions.
- Multiple staged oiled filtering foam for superior dust retaining capacity with high airflow.
- Washable and reusable.

|  |                              |           |          |
|--|------------------------------|-----------|----------|
| <b>Foam Replacement</b><br>(Not illustrated) | Maverick X3, Maverick X3 MAX | 715000713 | \$154.99 |
|--|------------------------------|-----------|----------|

- Replacement foam for Performance Twin Air Filter.

|                           |  |           |          |
|---------------------------|--|-----------|----------|
| <b>Snorkel Pre-Filter</b> | Maverick X3, Maverick X3 MAX<br>(with Snorkel Kit) | 715005599 | \$124.99 |
|---------------------------|--|-----------|----------|





- Pre-filter specifically for snorkels.
- Adds extra protection to your engine in harsh riding conditions.
- Helps keep air filter cleaner.
- Filter blocks particles larger than 0.005" (0.13 mm).
- Necessary to maintain vehicle warranty when tracks are installed.

|  |  |  |                 |
|--|--|--|-----------------|
| <b>Snorkel Kit</b>   | Maverick X3, Maverick X3 M AX (2019 and prior)   | 715003733  | <b>\$869.99</b> |
|  | Maverick X3, Maverick X3 M AX (2020 & up)  | 715007110  |                 |
|  | <ul style="list-style-type: none"> <li>Raises point of engine and CVT air intakes so vehicle can be semi-submerged in water or mud without the engine taking in water.</li> <li>Not compatible with S&amp;B Particle Separator, LinQ Pivoting Rack, Lonestar Racing Rear Intrusion Bar or any rear panels or windows.</li> </ul> | <ul style="list-style-type: none"> <li>Sealed Air Box 707800780 (sold separately) is required for installation on models manufactured before January 1, 2018.</li> <li>Standard on Maverick X3 X models.</li> <li>Not EC-compliant.</li> </ul> |                 |

|  |  |   |                   |
|--|--|---|-------------------|
| <b>Radiator Relocator</b>  | Maverick X3, Maverick X3 M AX  | 715004937   | <b>\$1,339.99</b> |
|  | <ul style="list-style-type: none"> <li>Relocates stock radiator to rear of cage.</li> <li>Protects it from debris and rocks.</li> <li>Prevents cooling performance loss in muddy conditions.</li> <li>Reduces hot air in the cabin.</li> <li>Easy to clean.</li> <li>Includes support hardware and hoses.</li> </ul> | <ul style="list-style-type: none"> <li>Not compatible with any bed accessories, Rear Cage mounted accessories, Complete MX Audio system and Upper Soft Doors (except LinQ 8 gal [30 L] Cooler Box).</li> <li>Radiator (709200703) is required for installation on 2017 models.</li> <li>Not compatible with full windshield.</li> </ul> |                   |

**WARNING:** Any modifications or addition of accessories may affect the handling of your vehicle. It is important to take the time to get familiar with the vehicle once modifications are made to understand how to adapt your driving behavior accordingly. Do not tamper with unauthorized modifications or installed equipment not specifically certified by BRP for the vehicle. These modifications have not been tested by BRP and they may increase the risk of injury or loss of control, or render the vehicle illegal to ride. Ask your authorized BRP dealer for suitable available accessories for your vehicle.

|  |   |           |                 |
|--|---|-----------|-----------------|
| <b>850 W Magneto Kit</b>   | Maverick X3, Maverick X3 M AX (2021 & up)   | 715006279 | <b>\$749.99</b> |
|  | <ul style="list-style-type: none"> <li>Increases the magneto output to 850 W.</li> <li>Includes rotor, stator and regulator.</li> </ul> |           |                 |

|   |   |           |                   |
|---|---|-----------|-------------------|
| <b>High Output 172 HP Upgrade Kit X3</b>  | Maverick X3, Maverick X3 M AX (2017 models)   | 715004700 | <b>\$1,629.99</b> |
|  | <ul style="list-style-type: none"> <li>Performance upgrade kit for Maverick X3 2017 models only.</li> <li>Gain 18 HP for a total of 172 HP.</li> <li>Includes: intercooler with fan, fuel pump catalyst and high performance belt.</li> <li>Installation must be done by an authorized BRP dealership to preserve the vehicle's warranty.</li> <li>C.A.R.B. Executive Order #D-799U.</li> </ul> |           |                   |

|   |   |           |                 |
|---|---|-----------|-----------------|
| <b>172 HP Intercooler Upgrade Kit</b><br><i>(Not illustrated)</i> | Maverick X3, Maverick X3 M AX (2018 and 2019)   | 715007137 | <b>\$899.99</b> |
|   | Maverick X3, Maverick X3 M AX (2020)  | 715007277 |                 |
|   | <ul style="list-style-type: none"> <li>Intercooler upgrade for the Maverick X3 2018 &amp; up.</li> <li>Installation must be done by an authorized BRP dealership to preserve the vehicle's warranty.</li> <li>Requires the Power Upgrade Installation Kit (715007111).</li> </ul> |           |                 |

## Emergency Accessories

|   |  |  |                 |
|---|--|--|-----------------|
| <b>Lonestar Racing Fire Extinguisher Support</b>                                    | Maverick X3, Maverick X3 M AX  | 715007320  | <b>\$219.99</b> |
|  | <ul style="list-style-type: none"> <li>Quick-release support that lets riders slide the fire extinguisher out in a matter of seconds in an emergency.</li> <li>Made of billet anodized black aluminum.</li> <li>Fits 1.85" (4.7 cm) tubing.</li> <li>Can be fixed anywhere on the cage.</li> <li>Provides riders with the safety and security of knowing they have dependable emergency equipment on board.</li> </ul> | <ul style="list-style-type: none"> <li>Comes with both billet mounts, quick-pull pin, mounting plate and two clamps.</li> <li>Fire extinguisher sold separately.</li> <li>"Lonestar Racing for Can-Am" branded.</li> </ul> |                 |

|   |   |           |                |
|---|---|-----------|----------------|
| <b>Fire Extinguisher</b>  |   | 295100833 | <b>\$33.99</b> |
|  | <ul style="list-style-type: none"> <li>Good for grease, oil and electrical fires.</li> <li>Fits with Lonestar Racing Fire Extinguisher Support Kit.</li> <li>Not EC-compliant.</li> </ul> |           |                |

**WARNING:** Any modifications or addition of accessories may affect the handling of your vehicle. It is important to take the time to get familiar with the vehicle once modifications are made to understand how to adapt your driving behavior accordingly. Do not tamper with unauthorized modifications or installed equipment not specifically certified by BRP for the vehicle. These modifications have not been tested by BRP and they may increase the risk of injury or loss of control, or render the vehicle illegal to ride. Ask your authorized BRP dealer for suitable available accessories for your vehicle.



## Emergency Kit

Maverick X3, Maverick X3 M AX

715006102

\$159.99



- Complete emergency kit provides all essential equipment and supplies to get out of most unfavorable situations power sport enthusiasts can find themselves in.
- Includes: Jim Per cables, air compressor, tire repair kit, ratchet tie-down, duct tape, 3,300 lb (1,500 kg) tow strap, zip ties, cloth rags.

# APACHE TRACK SYSTEMS



## Winter Tracks

Limited Warranty\*

### Apache Backcountry LT Track System

Maverick X3, Maverick X3 M AX

715004734



- Tracks designed to deliver the best snow performance on the market with unmatched flotation level and traction on snow surface.
- Large contact patch, 37% bigger than the Apache 360 LT.
- Ingressive added ground clearance of 7" (18 cm) helps keep the vehicle over the snow.
- Lightweight snowobile-inspired rail design.
- Aggressive track design with 2" (5 cm) lug height for maximum traction on snow.
- Apache Backcountry LT Mounting Kit, Track DPS Module and Engine and CVT Pre-Filter are required.
- Fine-tune your track system using extra HLRW heels, Siders with Vespel inserts and Rail Ice Scratcher.
- For winter use only.
- Track installation will affect vehicle width and length.

### Apache Backcountry LT Mounting Kit

(Not illustrated)

Maverick X3, Maverick X3 M AX

715004397 ·  
64" models

715004394 ·  
72" models

- Required for installation of the Apache Backcountry Track LT System.
- DPS Module and Pre-Filter are required and sold separately.

## Year-Round Tracks

Limited Warranty\*

### Apache 360 LT Track System

Maverick X3, Maverick X3 M AX

715005103



- Multifunctional tracks designed to support heavy loads and to fit on most Can-Am off-road vehicles.
- Extra contact patch adjustment for better performance over rough terrain.
- Contact patch is 7 to 9% bigger than the Apache 360's.
- Average ground clearance of 16" (41 cm), 1" (2.5 cm) lugs in the front and 1.25" (3.2 cm) in the back.
- EC compliant.
- Apache 360 LT Mounting Kit, Track DPS Module and Engine and CVT Pre-Filter Kit are required and sold separately.
- Recommended for use on snow only.

### Apache 360 LT Mounting Kit

(Not illustrated)

Maverick X3, Maverick X3 M AX

715004392 ·  
64" models

715004393 ·  
72" models

- Required for installation of the Apache 360 LT Track System.
- Track DPS Module and Pre-Filter not included.

\*The limited warranty is subject to the exclusions, limitations of liabilities and all other terms and conditions of BRP's standard limited warranty.

# APACHE TRACK SYSTEMS FITTING GUIDE

## Apache Backcountry LT

| Model Year / Model  | Track     | Track Mount | Track DPS Module  | Pre Iter without Snorkel    | Pre Iter with Snorkel |
|---|-----------|-------------|---|-----------------------------|-----------------------|
| 2017 & Up<br>Maverick X3, Maverick X3 MAX<br>(64" Models) | 715004734 | 715004397   | 715007338<br>Maverick X3,<br>Maverick X3 MAX<br>2022 & prior<br>(except Turbo RR<br>Engine)<br>OR<br>715006266<br>Maverick X3,<br>Maverick X3 MAX<br>2023, and 2022 &<br>prior with Turbo RR<br>Engines | 715005600<br>(except X MAX) | 715005599             |
| 2017 & Up<br>Maverick X3, Maverick X3 MAX<br>(72" Models) |           | 715004394   |   |                             |                       |

## Apache 360 LT

| Model Year / Model  | Track     | Track Mount | Track DPS Module  | Pre Iter without Snorkel | Pre Iter with Snorkel |
|---|-----------|-------------|---|--------------------------|-----------------------|
| 2017 & Up<br>Maverick X3, Maverick X3 MAX<br>(64" Models) | 715005103 | 715004392   | 715007338<br>Maverick X3,<br>Maverick X3 MAX<br>2022 & prior<br>(except Turbo RR<br>Engine)<br>OR<br>715006266<br>Maverick X3,<br>Maverick X3 MAX<br>2023, and 2022 &<br>prior with Turbo RR<br>Engines | 715005600                | 715005599             |
| 2017 & Up<br>Maverick X3, Maverick X3 MAX<br>(72" Models) |           | 715004393   |   |                          |                       |

\*The limited warranty is subject to the exclusions, limitations of liabilities and all other terms and conditions of BRP's standard limited warranty.

## Accessories

|                            |                                    |                  |
|----------------------------|------------------------------------|------------------|
| <b>Rail Ice Scratchers</b> | Apache Backcountry LT Track System | <b>860201728</b> |
|----------------------------|------------------------------------|------------------|



- Provide additional lubrication in hard and icy conditions.
- Rail mounted, small, light.
- Design expands on coil concept to allow reversing without damage.
- Easily stored when not in use.
- Extends slider life.

|  |                                    |                  |
|--|------------------------------------|------------------|
| <b>Apache Backcountry LT Wheel Kit</b> | Apache Backcountry LT Track System | <b>715006293</b> |
|--|------------------------------------|------------------|



- Additional wheel kit for Backcountry LT rear tracks.
- Reduces drag and rolling resistance in hard snow conditions or when transporting heavier loads.
- Extends slider life in hard snow conditions.
- Includes two wheels, cross shaft and mounting hardware per kit to service one track corner.
- Up to two kits per rear track can be installed.

|                                     |                                     |                  |
|-------------------------------------|-------------------------------------|------------------|
| <b>Sliders with Vespel® Inserts</b> | Apache Backcountry LT Track Systems | <b>503194815</b> |
|-------------------------------------|-------------------------------------|------------------|



- Use DuPont Vespel inserts for less friction.
- Longer life.
- Can be cut to desired length.
- 8 needed per vehicle.
- Sold individually.

|  |   |                  |
|--|---|------------------|
| <b>Track DPS Module</b><br>(Not illustrated) | Maverick X3, Maverick X3 MAX (Turbo RR Engine only)   | <b>715006266</b> |
|  | Maverick X3, Maverick X3 MAX (except Turbo RR Engine) | <b>715007338</b> |

- Innovative DPS module that ensures speedometer accuracy and optimized steering assist, making for perfect track control and riding ease.
- Required to install the Apache Track Systems.

## Engine & CVT Air Intake Pre-Filter

Maverick X3, Maverick X3 M AX (except X3 models)

715005600



- Adds extra protection to your engine in harsh riding conditions.
- Helps keep air filter cleaner.
- Filter blocks particles larger than 0.007" (0.19 mm).
- Easy installation.
- Not compatible with S & B Particle Separator.
- Necessary to maintain vehicle warranty when tracks are installed.

Required to install the Apache Backcountry LT and Apache 360 LT Track Systems.

# PROMOUNT FLOWS



## ProMount Plow Kits Reference Charts

|                | 72" Black Steel | 72" Yellow Steel | 72" Flex2 |
|----------------|-----------------|------------------|-----------|
| Plow Kit       | 715008176       | 715008177        | 715008175 |
| Blade          | 715004474       | 715006021        | 715004485 |
| Push Frame     | 715008116       | 715008116        | 715008116 |
| Mounting Plate | 715008197       | 715008197        | 715008197 |

## Can-Am ProMount Steel Plow Kits

### Can-Am ProMount Steel 72" (183 cm) Plow Kit

Maverick X3, Maverick X3 M AX

■ 715008176 - Black  
■ 715008177 - Yellow

\$1,279.97



- These kits include:
  - Can-Am ProMount Steel Blade
  - Push Frame with Quick-Attach System
  - Can-Am ProMount Mounting Plate

## Can-Am ProMount Steel Blades

### Can-Am ProMount Steel 72" (183 cm) Blade

Fits ProMount Push Frame

■ 715004474 - Black  
■ 715006021 - Yellow

\$479.99



- Plow blade made from 12-gauge steel.
- Replaceable wear blade.
- Large pin designed for easy blade rotation to eliminate snow buildup at pivot point.
- Blade design provides best snow roll-off at any angle.
- Clears 66" (1.68 m) when plow is fully angled.
- Blade height of 17" (43 cm).
- Compatible with Can-Am ProMount Blade accessories to further enhance plow versatility.
- Not compatible with S3 High Clearance Front A-Arm.

## Can-Am ProMount Angle Plows

### Can-Am ProMount 72" (183 cm) Steel Oneway State Blade

Fits ProMount Push Frame

715007264

\$539.99



- Make the job easier with the right tools, clearing alleys and make the task easier by sending the snow further out of the way.
- Wing end of plow measures 26" (67 cm) high and tapers down to 16" (41 cm).
- One-way "winged" state plow designed to throw snow higher.
- Rubber Flap (715007299) designed to keep snow away from the driver is offered as accessory (sold separately).
- Can-Am branded.

## Can-Am ProMount Flex2 Plow Kit

|   |                              |           |            |
|---|------------------------------|-----------|------------|
| <b>Can-Am ProMount Flex2 72" (183 cm) Blade</b> | Maverick X3, Maverick X3 MAX | 715008175 | \$1,389.97 |
|---|------------------------------|-----------|------------|



- These kits include:
  - Can-Am ProMount Flex2 Blade
  - Push Frame with Quick-Attach System
  - Can-Am ProMount Mounting Plate

## Can-Am ProMount Flex2 Blades

|   |                          |           |          |
|---|--------------------------|-----------|----------|
| <b>Can-Am ProMount Flex2 72" (183 cm) Blade</b> | Fits ProMount Push Frame | 715004485 | \$589.99 |
|---|--------------------------|-----------|----------|



- Plow blade made of UHMWPE, flexible and impact absorbing material prevents damaging your plow when accidental impact occurs.
- Replaceable wear blade.
- Large pin designed for easy blade rotation to eliminate snow buildup at pivot point.
- Blade design provides best snow roll-off at any angle.
- Clears 66" (168 cm) when plow is fully angled.
- Blade height of 17" (43 cm).
- Compatible with Can-Am ProMount Blade accessories to further enhance plow versatility.

## Can-Am ProMount Plow Accessories

|                                     |                              |           |         |
|-------------------------------------|------------------------------|-----------|---------|
| <b>Can-Am ProMount Edge Markers</b> | Maverick X3, Maverick X3 MAX | 715004206 | \$45.99 |
|-------------------------------------|------------------------------|-----------|---------|

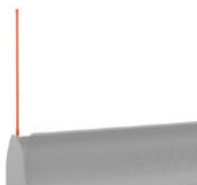

- Help locate the edges of your plow.
- Height: 24" (60 cm).
- Sold in pairs.
- Compatible with Can-Am ProMount Steel and Flex2 Blades with or without Blade Extensions (except for the Can-Am ProMount Steel 54" (137 cm) Blades).

|  |                              |           |          |
|--|------------------------------|-----------|----------|
| <b>Can-Am ProMount 72" (183 cm) Plastic Wear Blade</b> | Maverick X3, Maverick X3 MAX | 715004483 | \$199.99 |
|--|------------------------------|-----------|----------|



- Help prevent marks on your driveway.
- Compatible with Can-Am ProMount 72" (183 cm) Blades.

|                                      |                              |           |          |
|--------------------------------------|------------------------------|-----------|----------|
| <b>Can-Am ProMount Drift Cutters</b> | Maverick X3, Maverick X3 MAX | 715006258 | \$159.99 |
|--------------------------------------|------------------------------|-----------|----------|

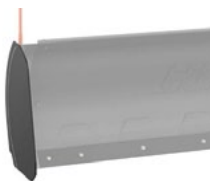

- Help keep snow in the plow.
- Dimensions: 17" x 13" (43.2 cm x 33 cm).
- Sold in pairs.
- Compatible with Can-Am ProMount Steel and Flex2 blades with or without Blade Extensions (except for the Can-Am ProMount Steel 54" (137 cm) Blades).

|   |                              |   |          |
|---|------------------------------|---|----------|
| <b>Can-Am ProMount Blade Extensions</b> | Maverick X3, Maverick X3 MAX | <ul style="list-style-type: none"> <li>■ 715004205 - Black</li> <li>■ 715005319 - Yellow</li> </ul> | \$119.99 |
|---|------------------------------|---|----------|



- These conveniently extend your Can-Am ProMount Blade.
- Add 3" (8 cm) each side.
- Compatible with Can-Am ProMount Blades (except for the Can-Am ProMount Steel 54" (137 cm) Blades).
- Longer Wear Blade can be installed to go over the extra length given by the extensions.





|   |                               |                  |                 |
|---|-------------------------------|------------------|-----------------|
| <b>Back Drag Blade</b><br><i>(Not illustrated)</i>  | ProMount Plows (60" and more) | <b>715007794</b> | <b>\$279.99</b> |
| <ul style="list-style-type: none"> <li>• Thick steel swivel scraper.</li> <li>• Lifts up when the vehicle is moving forward so as not to affect the scraping.</li> <li>• Increased capacity to pull snow.</li> <li>• More aggressive scraping in reverse mode.</li> <li>• Lifts the scraper off the ground so that it scrapes evenly.</li> <li>• Adjustable in length for compatibility with 60", 66" and 72" blades.</li> <li>• Compatible with ProMount blades (Flex and Steel).</li> <li>• Not compatible with Backcountry Track Kit.</li> </ul> |                               |                  |                 |

|  |                              |                                |                 |
|--|------------------------------|--------------------------------|-----------------|
| <b>Curved Wear Blade</b><br><i>(Not illustrated)</i>   | Maverick X3, Maverick X3 MAX | <b>715007793</b> -72" (183 cm) | <b>\$114.99</b> |
| <ul style="list-style-type: none"> <li>• Wear blade designed with a folded back bottom lip.</li> <li>• The increased surface allows for less digging while plowing uneven surfaces.</li> <li>• Ideal for snow covered gravel, grass, paver stone and other soft surfaces.</li> </ul> |                              |                                |                 |

## Can-Am ProMount Custom Solutions

|   |   |                  |                 |
|---|---|------------------|-----------------|
| <b>Can-Am ProMount Push Frame with Quick-Attach System</b>                        | Maverick X3, Maverick X3 MAX  | <b>715008116</b> | <b>\$559.99</b> |
|  | <ul style="list-style-type: none"> <li>• Heavy-duty steel tubes designed to withstand the roughest use.</li> <li>• Minimum mount carriage provides ultimate push strength and traction.</li> <li>• Designed for maximum plow lift height.</li> <li>• Features a self-aligning quick-attach system, an easy foot release pedal and an ergonomic handle for plow angle adjustment.</li> <li>• Plow Limit Switch recommended to extend winch cable lifespan.</li> <li>• Can-Am ProMount Mounting Plate required for installation.</li> <li>• Blade swivels left or right, 5 positions.</li> <li>• Large pin designed for easy blade rotation to eliminate dirt and snow buildup at pivot point.</li> <li>• Plow Roller Fairlead included.</li> </ul> |                  |                 |

|  |   |                  |                 |
|--|---|------------------|-----------------|
| <b>Can-Am ProMount Push Frame Extension</b>  | Maverick X3, Maverick X3 MAX  | <b>715006257</b> | <b>\$174.99</b> |
|  | <ul style="list-style-type: none"> <li>• 12" (30 cm) push frame extension required when plow is installed with Apache Track systems.</li> </ul> |                  |                 |

|   |   |                  |                 |
|---|---|------------------|-----------------|
| <b>Can-Am ProMount Mounting Plate</b>   | Maverick X3, Maverick X3 MAX  | <b>715008197</b> | <b>\$239.99</b> |
|  | <ul style="list-style-type: none"> <li>• Required to install the Can-Am ProMount Push Frame with Quick-Attach System.</li> <li>• Mounting plate precision designed to stay on year round without compromising ground clearance.</li> <li>• Comes with the Plow Roller Fairlead.</li> <li>• Not compatible with S3 High Clearance Front Axle.</li> </ul> |                  |                 |

|   |  |                  |                   |
|---|--|------------------|-------------------|
| <b>Can-Am ProMount Plow Angling System</b>  | Maverick X3, Maverick X3 MAX   | <b>715009241</b> | <b>\$1,099.99</b> |
|  | <ul style="list-style-type: none"> <li>• Converts your plow system into an easy-to-control unit from the driver's seat.</li> <li>• Allows you to have full up/down and left/right plow control at your fingertips with the supplied joystick.</li> <li>• Using one hand to control all plow motions allows you to easily concentrate and manage your plowing tasks.</li> <li>• Compatible with the SxS ProMount Push Frame and Blade.</li> <li>• Not compatible with Apache Backcountry LT Track System.</li> <li>• Push Frame Extension (715006257) is required for installation with the Front Rancher Bumper.</li> <li>• Winch and plow sold separately.</li> </ul> |                  |                   |

|   |                              |                  |                 |
|---|------------------------------|------------------|-----------------|
| <b>ProMount Plow Limit Switch</b><br><i>(Not illustrated)</i>   | Maverick X3, Maverick X3 MAX | <b>715006259</b> | <b>\$134.99</b> |
| <ul style="list-style-type: none"> <li>• For controlling the cable tension when over-raising your plow system.</li> <li>• Prevents winch, plow push frame and vehicle damage.</li> <li>• Sensor located for optimal lift height.</li> </ul> |                              |                  |                 |

|   |  |   |                |
|---|--|---|----------------|
| <b>Plow Roller Fairlead</b>   | Maverick X3, Maverick X3 MAX   | <b>715001223</b><br>• Cylindrical Roller Fairlead | <b>\$81.99</b> |
|  | <ul style="list-style-type: none"> <li>• Larger diameter roller reduces wear on wire rope for plow application.</li> <li>• Can be used with all ProMount plows.</li> </ul> |   |                |



## Trailer Cover

(Not illustrated)

|                 |           |          |
|-----------------|-----------|----------|
| Maverick X3     | 715005813 | \$409.99 |
| Maverick X3 MAX | 715005814 | \$509.99 |

- Heavy-duty canvas made of UV-resistant solution-dyed polyester.
- Inner soft liner protects windshield and colored panels from abrasion.
- All high-abrasion areas are reinforced with a double canvas layer.
- Weather-resistant trailer cover protects your vehicle during storage and transportation.
- Opening for fuel cap and cabin access on passenger side.
- Quick and easy installation.
- Designed to perfectly fit your vehicle with or without Can-Am accessories.

## Bolt-On<sup>†</sup> Retractable Ratcheting Tie-Downs

|           |         |
|-----------|---------|
| 295101072 | \$35.99 |
|-----------|---------|



- Perfect for transporting your power sport vehicle or securing loads.
- Mounts easily; bolts on any flat surface (e.g., truck bed or frame).
- 1" x 6' (2.5 cm x 1.8 m) tie-down strap with heavy-duty stitching that delivers a 500 lb (226 kg) working load strength and 1,500 lb (680 kg) break strength.
- Convenient retractable push button automatically slackens, spools and stores away strap, while the ratchet mechanism tightens the strap snugly to secure your vehicle or load into place.
- Rubber ratcheting handle provides firm grip, and the hook is vinyl coated to protect whatever surface it hooks into.
- Sold in pairs.

## Ratchet Tie-Downs

|                        |         |
|------------------------|---------|
| 715008309 - Black/Gray | \$24.49 |
|------------------------|---------|



- 400 lb (181 kg) safe working load.
- 1" x 10' (2.5 cm x 3 m) strap with Sea-Doo, SkiDoo and Can-Am logos.
- Deluxe ratchet with rubber handle.
- Coated S hooks.
- Pack of 2.

## Heavy-Duty Ratchet Tie-Down

|           |         |
|-----------|---------|
| 715008308 | \$44.99 |
|-----------|---------|



- 1,000 lb (454 kg) safe working load.
- 1.5 in. x 6 in. (38 mm x 1.5 m) strap with BRP brands.
- Deluxe ratchet with rubber handle.
- Black-coated clip hooks.
- 12" (300 mm) webbing included.
- Pack of two.

CAN AM MAVERICK R

A Can-Am Maverick R off-road vehicle is shown in motion on a dirt road. The vehicle is primarily silver and black with yellow accents on the front and side. It features a roll-over protection structure (ROPS) with a long LED light bar mounted on top. The driver is wearing a green helmet and goggles. The background consists of rolling, arid hills under a cloudy sky. The vehicle is kicking up a cloud of dust from its rear wheel.

**CAN-AM MAVERICK R**



# CAN-AM MAVERICK R

## FEATURED PACKAGES

|   |     |
|---|-----|
| 2024 M averick R                        | 124 |
| 2024 M averick R X                      | 126 |
| 2024 M averick R X rs                   | 128 |
| 2024 M averick R X RS w ith Sm art-Shox | 130 |

## COMPARATIVE CHART

132

## ACCESSORIES

|                                    |     |
|------------------------------------|-----|
| Roofs                              | 136 |
| W indshields & W ind Protection    | 136 |
| M irrors                           | 137 |
| UpperW ind Nets                    | 137 |
| HM W PE Skid Plates                | 138 |
| Bum pers & Guards                  | 138 |
| LinQ :Easy On,Easy O Cargo         | 140 |
| Racks & Storage                    | 144 |
| ACM & SM ART Accessories           | 147 |
| Lights                             | 148 |
| Audio System s                     | 151 |
| Electrical& Electronic Accessories | 152 |
| W inches                           | 153 |
| Perfom ance                        | 155 |





A close-up photograph of a person's arm resting on a piece of equipment. The person is wearing a black t-shirt and has a tattoo on their forearm that includes a map of North America. The equipment is primarily black with a prominent yellow section. On this yellow section, the word "MAVERICK" is printed in a bold, black, sans-serif font, followed by a white "R" that is partially cut off by the edge of the frame. The background is blurred, showing what appears to be the interior of a vehicle or a similar structure with some yellow and black patterns.

**MAVERICK R**

# 2024 MAVERICK

---



\*Smart-Lok was developed in conjunction with TEAM industries, a market leader in the drive train industry.  
All other trademarks are the property of their respective owners.





Catalyst Gray & Neo Yellow

## Feature highlights



### Load Management with a Knuckle

No ride delivers performance and ground clearance like the Can-Am Maverick R. Equipped with a 77 in. 4 Link Trailing Arm with Forged Aluminum heavy-duty Tall Knuckle, this side-by-side maximizes leverage on the wheels. Add tallup and you get effortless riding, better control and less fatigue for the driver and passenger.



### Grip It and Rip It

Smart-Lok™ is the most advanced off-road front differential. It's fully lockable on-the-fly, and its four automatic modes return them most grip possible in every condition when you ride the Can-Am Maverick R.



### Adapt to Changing Conditions

Ready for more? The FOX® 2.5 PODIUM Q3 PIGGYBACK shocks are designed to be stronger, lighter, and to help you seek thrills in the Can-Am Maverick R. Switch from soft to firm depending on the terrain you're riding on, then head out for more fun.



### Tenacious Tires and Wheels

The all-powerful Maverick R sits on 30 in. ITP Tenacity XNR tires with 15 in. Aluminum Flow Formed wheels. Lighter and just as durable, the flow formed wheels are a hybrid and the best of both worlds of the typical forged and cast wheels. For better acceleration and braking as you chase thrills, there's no better choice.

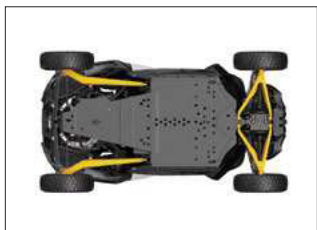

### Protection Wherever You Go

Ready for more thrills? This model sports a full skid plate for full protection under the unit. No matter the terrain or weather, you can keep riding and working in confidence knowing that the Can-Am Maverick R will glide smoothly over obstacles of all sizes.



### Always Wear Your Seat Belt

You hope you'll never need it, but the 3-point retractable seat belt in the Maverick R is there to keep you safe.



### This One Says It All!

The Can-Am Maverick R is equipped with a center dashboard that doubles as storage space and a cellphone holder. Rigid and durable, this feature protects your wallet, keys, or whatever else you need from the wild elements. Plus, the magnet on the holder keeps your smartphone in place as it charges up.



### You Like Power?

The Maverick R increases the magneto output to 1,700 W for even more power. Whether you'd like to have high-performance lights when you ride or plug in more accessories than most riders can think of, the 1700 W magneto can handle it.

# 2024 MAVERICK RX

---



\*Smart-Lok was developed in conjunction with TEAM industries, a market leader in the drive train industry. All other trademarks are the property of their respective owners.





Legion Red

## Feature highlights



### Load Management with a Knuckle

No ride delivers performance and ground clearance like the Can-Am Maverick R X. Equipped with a 77 in. 4 Link Trailing Arm with Forged Aluminum heavy-duty Tall Knuckle, this side-by-side maximizes leverage on the wheels. Add tallup and you get effortless riding, better control and less fatigue for the driver and passenger.



### Grip It and Rip It

Smart-Lok™ is the most advanced off-road front differential. It's fully lockable on-the-fly, and its four automatic modes return the most grip possible in every condition when you ride the Can-Am Maverick R X.



### Adapt to Changing Conditions

Ready for more? The FOX® 2.5 PODIUM Piggyback shocks with QS3® compression adjustment and bottom-out controls are designed to be stronger and lighter, and to help you seek thrills in the Can-Am Maverick R X. Switch from soft to firm depending on the terrain you're riding on, then head out for more fun.



### It All Fits on a Screen!

The Maverick R X comes with a 10.25 in. infotainment touchscreen display, putting everything you need for a perfect adventure at your fingertips. With a premium design, an intuitive interface and enhanced connectivity experience, this feature delivers on the promise of an elevated experience.



### Tenacious Tires and Wheels

The all-powerful Maverick R X sits on 30 in. TTP Tenacity XNR tires with 15 in. Aluminum Flow Formed wheels. Lighter and just as durable, the flow-formed wheels are a hybrid and the best of both worlds of the typical forged and cast wheels. For better acceleration and braking as you chase thrills, there's no better choice.

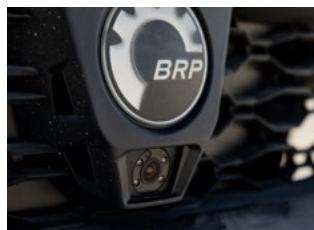

### Eyes in the Back!

Overcome all challenges and obstacles when you ride in a Maverick R X equipped with a rear camera. Activated under 20 kph (12 mph) and of 756x504 quality, this camera spots the things you miss to keep your focus on what matters most: exploring, pushing forward and having a fun time.



### Putting Your Infotainment First

The new telescopic steering wheel with infotainment controls on this unit allows you to stay connected while enjoying the ride. With paddle shifters and a square design that enhances rider comfort, you'll have everything you need for a comfy ride at your fingertips: app switcher, ride settings, phone voice assistants and buttons to navigate up and down.



### All-Around Protection

Over your head in the Maverick R X is a full hard roof. For better protection from the elements, this full rigid top is an easy choice. Keep sunlight or rain away and continue pushing limits. This model also has a full skid plate for full protection under the unit. No matter the terrain or weather, you can get after it knowing that the vehicle will glide smoothly over obstacles of all sizes.

# 2024 MAVERICK RX<sup>RS</sup>

---



\*Smart-Lok was developed in conjunction with TEAM industries, a market leader in the drive train industry. All other trademarks are the property of their respective owners.



■ Triple Black

## Feature highlights



### Load Management with a Knuckle

No ride delivers performance and ground clearance like the Can-Am Maverick R X rs. Equipped with a 77 in. 4 Link Trailing Arm with Forged Aluminum heavy-duty TallKnuckle, this side-by-side maximizes leverage on the wheels. Add it all up and you get effortless riding, better control and less fatigue for the driver and passenger.



### Grip It and Rip It

Smart-Lok™ is the most advanced off-road front differential. It's fully lockable on-the-fly, and its four automatic modes return the most grip possible in every condition when you ride the Can-Am Maverick R X rs.



### Adapt to Changing Conditions

Ready for more? The FOX® 3.0 PODIUM RC2® Piggyback with bypass, dual speed compression and rebound adjustments are designed to be stronger and lighter, and to help you seek thrills in the Can-Am Maverick R X rs. Switch from soft to firm depending on the terrain you're riding on, then head out for more fun.



### It All Fits on a Screen!

The Maverick R X rs comes with a 10.25 in. infotainment touchscreen display, putting everything you need for a perfect adventure at your fingertips. With a premium design, an intuitive interface and enhanced connectivity experience, this feature delivers on the promise of an elevated experience.

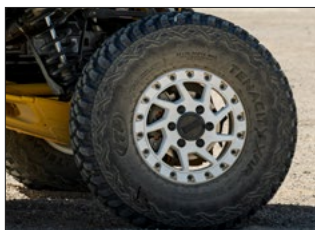

### Tenacious Tires and Wheels

The all-powerful Maverick R X rs sits on 32 in. ITP Tenacity XNR tires with 16 in. Aluminum Flow Formed Beadlock wheels. Lighter and just as durable, the flow-form ed wheels are a hybrid of the best of both worlds of the typical forged and cast wheels. For better acceleration and braking as you chase thrills, there's no better choice.

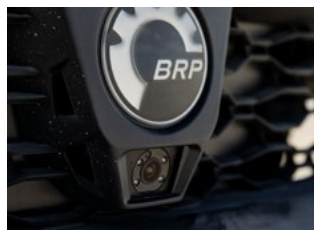

### Eyes in the Back!

Overcome all challenges and obstacles when you ride in a Maverick R X rs equipped with a front and rear camera. Activated under 20 kph (12 mph) and of 756x504 quality, this camera spots the things you miss to keep your focus on what matters most: exploring, pushing forward and having a fun time.



### Putting Your Infotainment First

The new telescopic steering wheel with infotainment controls on this unit allows you to stay connected while enjoying the ride. With paddle shifters and a square design that enhances rider comfort, you'll have everything you need for a comfy ride at your fingertips: app switcher, ride settings, phone voice assistants and buttons to navigate up and down.



### All-Around Protection

Over your head in the Maverick R X rs is a full hard roof. For better protection from the weather elements, this full rigid top is an easy choice. Keep sunlight or rain away and continue pushing limits. This model also has a full skid plate for full protection under the unit. No matter the terrain or weather, you can get after it knowing that the vehicle will glide smoothly over obstacles of all sizes.

# 2024 MAVERICK RX<sup>RS</sup> WITH SMART-SHOX



- Carbon Black & Neo Yellow
- Triple Black

ENGINE

COAST DOCK

## PACKAGES

- 77 in
- Smart-Lok
- FOX<sup>®</sup> Smart-Shox<sup>™</sup>
- 10.2 ft
- 32 in
- 16 in
- Front
- Teleskop
- Full r
- Full s
- 4-poi
- Pre-r
- Can-
- Cent
- X par
- 1,700

PRICE

\*Smart-Lok was developed in conjunction with TEAM industries, a market leader in the drive train industry.  
 \*\*Smart-Shox was developed in conjunction with FOX and Tractive Industries, a market leader in the suspension industry.  
 All other trademarks are the property of their respective owners.





Carbon Black & Neo Yellow

## Feature highlights



### Load Management with a Knuckle

No ride delivers performance and ground clearance like the Can-Am Maverick X3 with Smart-Shox. Equipped with a 77 in. 4 Link Trailing Arm with Forged Aluminum heavy-duty Tall Knuckle, this side-by-side maximizes leverage on the wheels. Add it all up and you get effortless riding, better control and less fatigue for the driver and passenger.



### Grip It and Rip It

Smart-Lok™ is the most advanced off-road front differential. It's fully lockable on-the-fly, and its four automatic modes return the most grip possible in every condition when you ride the Can-Am Maverick X3 with Smart-Shox.



### Bypass the stress and obstacles

The Live Valve Gen 3 with Dual Valve compression and rebound on the Maverick X3 with Smart-Shox will make you fall in love in no time! Using the same race-proven damping technology as our external bypass shocks on our trophy trucks, the FOX® 3.0 PODIUM® shocks with bypass turn your sidekick into the star of the show.



### It All Fits on a Screen!

The Maverick X3 with Smart-Shox comes with a 10.25 in. infotainment touchscreen display, putting everything you need for a perfect adventure at your fingertips. With a premium design, an intuitive interface and enhanced connectivity experience, this feature delivers on the promise of an elevated experience.



### Tenacious Tires and Wheels

The all-powerful Maverick X3 with Smart-Shox sits on 32 in. ITP Tenacity XNR tires with 16 in. Aluminum Flow Formed Beadlock wheels. Lighter and just as durable, the flow-form wheels are a hybrid and the best of both worlds of the typical forged and cast wheels. For better acceleration and braking as you chase thrills, there's no better choice.



### Eyes in the Back!

Overcome all challenges and obstacles when you ride in a Maverick X3 with Smart-Shox equipped with a front and rear camera. Activated under 20 kph (12 mph) and of 756x504 quality, this camera spots the things you miss to keep your focus on what matters most: exploring, pushing forward and having a fun time.



### Putting Your Infotainment First

The new telescopic steering wheel with infotainment controls on this unit allows you to stay connected while enjoying the ride. With paddle shifters and a square design that enhances rider comfort, you'll have everything you need for a comfy ride at your fingertips: app switcheR, ride settings, phone voice assistants and buttons to navigate up and down.



### All-Around Protection

Over your head in the Maverick X3 with Smart-Shox is a full hard roof. For better protection from the weather elements, this full rigid top is an easy choice. Keep sunlight or rain away and getting tasks done. This model also has a full skid plate for full protection under the unit. No matter the terrain or weather, you can get after it knowing that the vehicle will glide smoothly over obstacles of all sizes.

|                       |                              | MAVERICK R***   | MAVERICK R X***   | MAVERICK R X rs***  | MAVERICK R X rs with Smart-Shox***  |
|-----------------------|------------------------------|---|---|---|---|
|                       |                              |    |    |   |    |
| COLOR OPTIONS         |                              | Catalyst Gray & Neo Yellow  | Legion Red Triple Black   | Carbon Black & Neo Yellow Triple Black  | Carbon Black & Neo Yellow Triple Black  |
| ENGINES               | Type                         | 240 hp, Rotax® 999T DCT engine, 999 cc turbocharged triple-cylinder engine, liquid-cooled w/ integrated intercooler and high-performance air filter | 240 hp, Rotax® 999T DCT engine, 999 cc turbocharged triple-cylinder engine, liquid-cooled w/ integrated intercooler and high-performance air filter | 240 hp, Rotax® 999T DCT engine, 999 cc turbocharged triple-cylinder engine, liquid-cooled w/ integrated intercooler and high-performance air filter | 240 hp, Rotax® 999T DCT engine, 999 cc turbocharged triple-cylinder engine, liquid-cooled w/ integrated intercooler and high-performance air filter |
|                       | Fuel Delivery System         | Intelligent Throttle Control (ITC™) w/ Electronic Fuel Injection (EFI)  | Intelligent Throttle Control (ITC™) w/ Electronic Fuel Injection (EFI)  | Intelligent Throttle Control (ITC™) w/ Electronic Fuel Injection (EFI)  | Intelligent Throttle Control (ITC™) w/ Electronic Fuel Injection (EFI)  |
|                       | Transmission                 | Rotax® DCT, 7 speed w/ high and low range   | Rotax® DCT, 7 speed w/ high and low range   | Rotax® DCT, 7 speed w/ high and low range   | Rotax® DCT, 7 speed w/ high and low range   |
|                       | Drive Train                  | Lockable front differential w/ exclusive Smart-Lok™ True 2W D / 4W D w/ front diff. lock / 4W D TRAIL ACTV / 4W D TRAIL                             | Lockable front differential w/ exclusive Smart-Lok™ True 2W D / 4W D w/ front diff. lock / 4W D TRAIL ACTV / 4W D TRAIL                             | Lockable front differential w/ exclusive Smart-Lok™ True 2W D / 4W D w/ front diff. lock / 4W D TRAIL ACTV / 4W D TRAIL                             | Lockable front differential w/ exclusive Smart-Lok™ True 2W D / 4W D w/ front diff. lock / 4W D TRAIL ACTV / 4W D TRAIL                             |
|                       | Power Steering               | Gen 2 Trim mode DPS™ high torque  | Gen 2 Trim mode DPS™ high torque  | Gen 2 Trim mode DPS™ high torque  | Gen 2 Trim mode DPS™ high torque  |
| SUSPENSIONS           | Front Suspension             | Forged aluminum heavy-duty talknuckle Double A-arm w/ sh swaybar / 25 in. (63.5 cm) suspension travel   | Forged aluminum heavy-duty talknuckle Double A-arm w/ sh swaybar / 25 in. (63.5 cm) suspension travel   | Forged aluminum heavy-duty talknuckle Double A-arm w/ sh swaybar / 25 in. (63.5 cm) suspension travel   | Forged aluminum heavy-duty talknuckle Double A-arm w/ sh swaybar / 25 in. (63.5 cm) suspension travel   |
|                       | Front Shocks                 | FOX® 2.5 PODIUM Piggyback w/ sh QS3™ compression adjustment   | FOX® 2.5 PODIUM Piggyback w/ sh QS3™ compression adjustment   | FOX® 2.5 PODIUM RC2™ Piggyback w/ sh bypass, dual speed compression and rebound adjustments   | FOX® 2.5 PODIUM™ Piggyback w/ sh bypass and Smart-Shox™ Technology featuring Live Valve gen 3 (live valve compression and rebound)                  |
|                       | Rear Suspension              | 4-link trailing arm w/ sh forged aluminum heavy-duty talknuckle / 25 in. (63.5 cm) suspension travel  | 4-link trailing arm w/ sh forged aluminum heavy-duty talknuckle / 25 in. (63.5 cm) suspension travel  | 4-link trailing arm w/ sh forged aluminum heavy-duty talknuckle / 25 in. (64.8 cm) suspension travel  | 4-link trailing arm w/ sh forged aluminum heavy-duty talknuckle / 26 in. (66 cm) suspension travel  |
|                       | Rear Shocks                  | FOX® 2.5 PODIUM Piggyback w/ sh QS3™ compression adjustment and bottom-out control  | FOX® 2.5 PODIUM Piggyback w/ sh QS3™ compression adjustment and bottom-out control  | FOX® 3.0 PODIUM RC2™ Piggyback w/ sh bypass, dual speed compression and rebound adjustments   | FOX® 3.0 PODIUM™ Piggyback w/ sh bypass and Smart-Shox™ Technology featuring Live Valve gen 3 (live valve compression and rebound)                  |
| TIRES WHEELS          | Front / Rear Tires<br>Wheels | 1P Tenacy XNR 30 x 10 x 15 in. 15 in. aluminum flow formed  | 1P Tenacy XNR 30 x 10 x 15 in. 15 in. aluminum flow formed  | 1P Tenacy XNR 32 x 10 x 16 in. 16 in. aluminum flow formed beadlock   | 1P Tenacy XNR 32 x 10 x 16 in. 16 in. aluminum flow formed beadlock   |
| BRAKES                | Front                        | 32 mm hydraulic triple-piston caliper w/ sh a 265 mm disc   | 32 mm hydraulic triple-piston caliper w/ sh a 265 mm disc   | 32 mm hydraulic triple-piston caliper w/ sh a 265 mm disc   | 32 mm hydraulic triple-piston caliper w/ sh a 265 mm disc   |
|                       | Rear                         | 30 mm hydraulic twin-piston caliper w/ sh a 255 mm disc   | 30 mm hydraulic twin-piston caliper w/ sh a 255 mm disc   | 30 mm hydraulic twin-piston caliper w/ sh a 255 mm disc   | 30 mm hydraulic twin-piston caliper w/ sh a 255 mm disc   |
| DIMENSIONS CAPACITIES | Estimated Dry Weight         | 2,150 lb (975 kg)   | 2,225 lb (1,009 kg)   | 2,240 lb (1,016 kg)   | 2,250 lb (1,020 kg)   |
|                       | Chassis / Cage               | High-strength (dual-phase) steel tubing and stampings   | High-strength (dual-phase) steel tubing and stampings   | High-strength (dual-phase) steel tubing and stampings   | High-strength (dual-phase) steel tubing and stampings   |
|                       | L x W x H                    | 138.7 x 78.1 x 67.7 in. (652.2 x 198.5 x 171.9 cm)  | 138.7 x 78.1 x 70.4 in. (652.2 x 198.5 x 177.8 cm)  | 140 x 78.1 x 71.5 in. (655.6 x 198.5 x 181.5 cm)  | 140 x 78.1 x 71.5 in. (655.6 x 198.5 x 181.5 cm)  |
|                       | Wheelbase                    | 108 in. (274.3 cm)  | 108 in. (274.3 cm)  | 108 in. (274.3 cm)  | 108 in. (274.3 cm)  |
|                       | Ground Clearance             | 17 in. (43.2 cm)  | 17 in. (43.2 cm)  | 17 in. (43.2 cm)  | 17 in. (43.2 cm)  |
|                       | Rack Capacity                | 200 lb (90 kg)  | 200 lb (90 kg)  | 200 lb (90 kg)  | 200 lb (90 kg)  |
|                       | Storage Capacity             | Total: 2.1 gal (8.1 L)  | Total: 2.1 gal (8.1 L)  | Total: 2.1 gal (8.1 L)  | Total: 2.1 gal (8.1 L)  |
|                       | Fuel Capacity                | 13.2 gal (60 L)   | 13.2 gal (60 L)   | 13.2 gal (60 L)   | 13.2 gal (60 L)   |
| FEATURES              | Gauge                        | 7.6 in. wide digital display w/ sh keypad   | 4.5 in. wide digital display w/ sh keypad and 10.25 in. touchscreen display   | 4.5 in. wide digital display w/ sh keypad and 10.25 in. touchscreen display   | 4.5 in. wide digital display w/ sh keypad and 10.25 in. touchscreen display   |
|                       | Instrumentation              | USB A (charging port) DC outlet (10 A)  | USB A (charging port and communication port) DC outlet (10 A)   | USB A (charging port and communication port) DC outlet (10 A)   | USB A (charging port and communication port) DC outlet (10 A)   |
|                       | Anti-Theft System            | RFD digitally Encoded Security System (DESS™) w/ sh start/stop button   | RFD digitally Encoded Security System (DESS™) w/ sh start/stop button   | RFD digitally Encoded Security System (DESS™) w/ sh start/stop button   | RFD digitally Encoded Security System (DESS™) w/ sh start/stop button   |
|                       | Lighting                     | Premium high-performance LED headlights   | Premium high-performance LED headlights Can-Am LED signature  | Premium high-performance LED headlights Can-Am LED signature  | Premium high-performance LED headlights Can-Am LED signature  |
|                       | Winch                        | 4,500 lb (2,041 kg) w/ inch-ready bump per (not installed)  | 4,500 lb (2,041 kg) w/ inch-ready bump per (not installed)  | 4,500 lb (2,041 kg) w/ inch-ready bump per (not installed)  | 4,500 lb (2,041 kg) w/ inch-ready bump per (not installed)  |
|                       | Magneto                      | 1,700 W   | 1,700 W   | 1,700 W   | 1,700 W   |
|                       | Protection                   | Premium half doors<br>Front lower deflector<br>Front / rear anchor<br>Full plastic skid plate   | Full roof<br>Premium half doors<br>Front lower deflector<br>Front / rear anchor<br>Full plastic skid plate  | Full roof<br>Premium half doors<br>Front lower deflector<br>Front / rear anchor<br>Full plastic skid plate  | Full roof<br>Premium half doors<br>Front lower deflector<br>Front / rear anchor<br>Full plastic skid plate  |

\*Smart-Lok was developed in conjunction with TEAM Industries, a market leader in the drive train industry.  
 \*\*Smart-Shox was developed in conjunction with Tractec Industries, a market leader in the suspension industry.  
 \*\*\*6-month BRP limited warranty, BEST term available up to 30 months.





---

# MAVERICK R ACCESSORIES

---

# BUNDLE UP TO LEAVE YOUR MARK YOUR MAVERICK BUNDLES

## STEP 1: CHOOSE YOUR ESSENTIAL BUNDLE

|          |                                   | Maverick R |
|----------|-----------------------------------|------------|
| STARTER  | Aluminum Side Mirrors             | 715007363  |
|          | Electronic Device Holder          | 715007176  |
|          | LinQ Side Cargo Boxes (13.5 L)    | 715007372  |
|          | Upper Door Storage Bags           | 715008065  |
| ADVANCED | Glass Windshield                  | 715007181  |
|          | Cold Air Roof Scoop               | 715008280  |
|          | Rear Wind Screen                  | 715007317  |
|          | XPS Screen Protector              | 860202680  |
| PEAK     | Interior Wiper & Washer Kit       | 715007173  |
|          | Wiper & Washer Kit Wiring Harness | 715008855  |
|          | Mud & Dust Wash                   | 9779340    |
|          | Multi-Surface Glass Cleaner       | 9779331    |

## STEP 2: PICK YOUR ADD-ON BUNDLE

|              |   | Maverick R |
|--------------|---|------------|
| ACM          | Accessory Control Module                | 715009796  |
|              | Rear ACM Harness                        | 715009268  |
|              | SMART Control Center for ACM            | 715007712  |
| SMART LIGHTS | SMART Integrated LED Side Mirror Lights | 715007185  |
|              | SMART Integrated LED Hood Light         | 715007378  |
|              | SMART Integrated LED Roof Light         | 715007322  |
|              | SMART LED Chase Lights                  | 715007727  |
| AUDIO        | Can-Am JL Audio System -Level 5         | 715007957  |
|              | Auxiliary Battery Installation Kit      | 715007837  |
| ADVENTURE    | Desert Front Bumper                     | 715007311  |
|              | LinQ Trunk Box (96L)                    | 715007182  |
|              | Adventure Roof Rack                     | 715007186  |
|              | LinQ Pivoting Rack                      | 715007306  |



# YOU DESERVE THE BEST. THE ESSENTIAL MAVERICK R BUNDLE

## YOU WANT IT ALL? WE'VE GOT IT ALL!

Maverick R

NOTHING  
BUT  
THE BEST

|   |           |
|---|-----------|
| Aluminum Side Mirrors                   | 715007363 |
| Electronic Device Holder                | 715007176 |
| LinQ Pivoting Rack                      | 715007306 |
| LinQ Side Cargo Boxes (13.5 L)          | 715007372 |
| LinQ Trunk Box (96 L)                   | 715007182 |
| Upper Door Storage Bags                 | 715008065 |
| Overhead Storage Bag                    | 715007379 |
| Shoulder Storage Bag                    | 715007371 |
| Glass Windshield                        | 715007181 |
| Cold Air Roof Scoop                     | 715008280 |
| Rear Wind Screen                        | 715007317 |
| Upper Wind Nets                         | 715007376 |
| XPS Screen Protector                    | 860202680 |
| Accessory Control Module                | 715009796 |
| Rear ACM Harness                        | 715009268 |
| SMART Control Center for ACM            | 715007712 |
| SMART Integrated LED Side Mirror Lights | 715007185 |
| SMART Integrated LED Hood Light         | 715007378 |
| SMART Integrated LED Roof Light         | 715007322 |
| SMART LED Chase Lights                  | 715007727 |
| Intermittent Wiper & Washer Kit         | 715007173 |
| Can-Am JL Audio System -Level 5         | 715007957 |
| Can-Am JL Audio Roof-Level 4            | 715007309 |
| Auxiliary Battery Installation Kit      | 715007837 |
| Rock Sliders                            | 715007170 |
| Desert Front Bumper                     | 715007311 |
| Desert Rear Bumper                      | 715007172 |
| HMWPE Skid Plate Kit                    | 715007373 |
| Front Intrusion Bar                     | 715007312 |
| Mud & Dust Wash                         | 9779340   |
| Multi-Surface Glass Cleaner             | 9779331   |



|                       |            |           |          |
|-----------------------|------------|-----------|----------|
| <b>NEW Sport Roof</b> | Maverick R | 715007364 | \$499.99 |
|-----------------------|------------|-----------|----------|



- Impact-resistant injected polypropylene.
- Provides excellent protection from the elements and downhill visibility.
- Designed to work with the Cold Air Roof Scoop (715008280).
- Windshield compatible.

|                                |            |           |          |
|--------------------------------|------------|-----------|----------|
| <b>NEW Cold Air Roof Scoop</b> | Maverick R | 715008280 | \$499.99 |
|--------------------------------|------------|-----------|----------|



- Feeds fresh air to the engine compartment.
- Sleek design for a sleek racing look.
- Increases cold air to the intake to prevent power loss.
- Required when using a full windshield.
- Requires a Sport Roof for Can-Am JL Audio Roof-Level 4.
- Not compatible with the Audio Roof Flip Kit.

# WINDSHIELDS & WIND PROTECTION



## Windshields

|                             |            |           |            |
|-----------------------------|------------|-----------|------------|
| <b>NEW Glass Windshield</b> | Maverick R | 715007181 | \$1,259.99 |
|-----------------------------|------------|-----------|------------|



- Curved and laminated glass full windshield.
- Seals firmly against the cage and protects both the rider and the passenger from the elements.
- Provides maximum optical clarity and abrasion resistance.
- Must be used with the Wiper & Washer Kit for clear visibility during severe riding conditions, including mud riding.
- Use with rear wind protection to maximize passenger comfort.
- Must be used with the Cold Air Roof Scoop (715008280).
- Compatible with the SMART Integrated Roof LED Light.
- Not compatible with the Audio Roof Flip Kit (715008164).

|   |            |           |          |
|---|------------|-----------|----------|
| <b>NEW Full Windshield - Hardcoated</b> | Maverick R | 715007321 | \$899.99 |
|---|------------|-----------|----------|



- Highly impact-resistant Quantum<sup>®</sup> hardcoated polycarbonate full windshield.
- Formed polycarbonate construction for enhanced rigidity.
- Provides excellent optical clarity and better abrasion resistance.
- Protects the driver and the passenger from the elements.
- Quick and easy toolless removal.
- Use with rear wind protection to maximize comfort for the passenger.
- Can be used with the Windshield Wiper & Washer Kit (715007173) (light-duty usage only).
- Compatible with SMART Integrated Roof LED Light.
- Must be used with the Cold Air Roof Scoop (715008280).
- Not compatible with the Audio Roof Flip Kit (715008164).

|  |            |           |          |
|--|------------|-----------|----------|
| <b>Intermittent Wiper &amp; Washer Kit</b> | Maverick R | 715007173 | \$699.99 |
|--|------------|-----------|----------|



- An ideal way to keep your windshield clear in the rain, or while riding through mud and water.
- The wiper mechanism and washer fluid dispenser are perfectly concealed on the vehicle.
- The wiper and washer fluid dispenser installs at the bottom of the windscreen for maximum visibility.
- For use on Glass or Hardcoated Windshields.
- Intermittent wipers feature available when the kit is installed in combination with ACM.
- Electric Harness required (715008855) to hook up and operate the Wiper & Washer Kits when ACM is not installed. Sold separately.

|                             |            |           |          |
|-----------------------------|------------|-----------|----------|
| <b>NEW Manual Wiper Kit</b> | Maverick R | 715009424 | \$119.99 |
|-----------------------------|------------|-----------|----------|



- Single manual wiper that can be used to clear windshield of debris.
- Easy to install system that requires no electrical hookup.
- Large ergonomic handle provides a good grip over the entire sweeping surface.
- Compatible with glass and hardcoated windshields that use top mounted wipers.

## Rear Wind Protection

### NEW Rear Polycarbonate Window

Maverick R

715007315

\$429.99



- High impact-resistant polycarbonate window.
- Reduces windshield backdraft and stops dust and rain from entering the cabin for added comfort.
- Quick and easy installation.
- Designed to work with Can-Am's JL Audio Level-3 and 5 rear speakers, and all models.

### NEW Rear Wind Screen

Maverick R

715007317

\$139.99

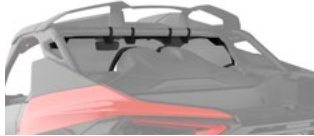

- Full rear mesh screen reduces windshield backdraft for added cabin comfort.
- Installs quickly and easily on roll cage.

## MIRRORS



### NEW Aluminum Side Mirrors

Maverick R

715007363

\$329.99



- Sleek design.
- High-quality black anodized aluminum for extreme durability.
- The convex surface provides a wider field of view and better visibility around the unit.
- Can be installed at any height on the cage A-pillar for optimized ride vision.
- Possibility to install the Integrated LED Side Mirror Lights (715007185).
- Adjustable ball-joint mirrors.
- Possibility to fold down the mirrors (fold-away mechanism).
- Compatible with windshields and upper door net.
- Sold in pairs.

### NEW Side Mirrors

Maverick R

715007188

\$199.99



- Sleek design.
- High-impact resistant plastic mirrors.
- The convex surface provides a wider field of view and better visibility around the unit. Can be installed at any height on the cage A-pillar for optimized ride vision.
- Adjustable ball-joint mirrors.
- Possibility to fold down the mirrors (fold-away mechanism).
- Compatible with windshields and upper door net.
- Sold in pairs.

### Rear View Mirror and Camera Monitor

Maverick R

715009410

\$499.99



- Fully waterproof rearview mirror and monitor kit.
- See exactly what you need to see with the multiple camera feeds from the rearview camera.
- This unit replaces the stock rearview mirror (the screen is integrated in the unit's replacement rearview mirror).
- The camera uses infrared light for night vision capabilities.

## UPPER WIND NETS



### NEW Upper Wind Nets

Maverick R

715007376

\$529.99



- This complete mesh screen net with a steel frame attaches to the door of the vehicle for added protection from the wind and mud.
- Easy to use, it follows the door's movements.
- Facilitates ingress and egress.
- The net zips up and down for added ventilation when required.
- Sold in pairs.

# HM WPE SKID PLATES

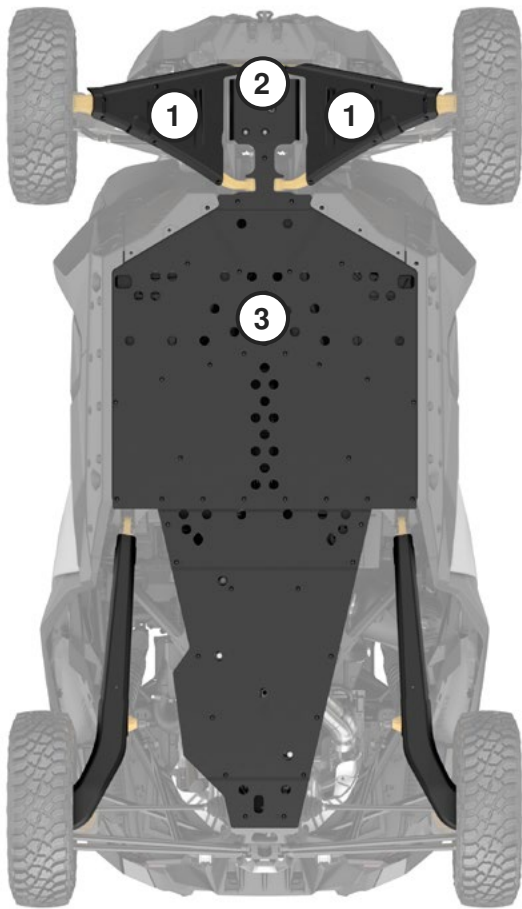

## MAVERICK

2023

### HM WPE Skid Plate Protection Kit

715007373

#### Individual HM WPE Skid Plates

|   |  |           |
|---|--|-----------|
| ① | HM WPE Front A-Arm and Trailing Arm Protectors | 715007183 |
| ② | HM WPE Front Skid Plate                        | 715007313 |
| ③ | HM WPE Underbelly Plate                        | 715007314 |

Our plastic plates glide smoothly and silently over obstacles, offering great protection in rough terrain. Made of abrasion-resistant thermoplastic (1.0 mm) thick High Molecular Weight Polyethylene (HM WPE).

- Lighter than aluminum.
- Superior stress crack resistance.
- High impact strength.

# BUMPERS & GUARDS



## Bumpers

### NEW Trail Front Bumpers

Maverick R

■ 715007803 - Black  
■ 715008763 - Yellow

\$599.99



- Can-Am's largest front bumper protects the headlights and radiator area of the unit.
- Added heavy-duty protection in extreme driving conditions.
- Made of 1.5" (3.8 cm) diameter steel tubing.
- Anticorrosion coating with durable powdercoat finish.
- Combine with the Rock Sliders and Rear Bumper for ultimate protection.
- Features integrated mounting points for lights.
- Winch compatible.

### NEW Desert Front Bumpers

Maverick R

■ 715007311 - Black  
■ 715007691 - Yellow

\$429.99



- Sleek and rugged design.
- Provides added protection without sacrificing the agility and performance of the vehicle.
- Made of heavy-duty steel profiled tubing to protect the front of the unit.
- Inside and outside anticorrosion coating with durable powdercoat finish.
- Combine with the Rock Sliders and Rear Bumper for ultimate protection.
- Features integrated mounting points for lights.
- Winch compatible.



## NEW Dune Front Bumpers

Maverick R

■ 715007169 · Black  
■ 715007305 · Raw Metal

\$439.99



- Highly integrated bumper that creates a more pronounced attack angle and provides added protection to the vehicle.
- Allows for better ground clearance.
- The sleek design gives the unit a sportier look.
- Made of heavy-duty steel with a 1/8" (3 mm) aluminum plate.
- Inside and outside anti-corrosion coating with durable powder coat finish.
- Features an integrated Tow Hook.
- Not width compatible.

## NEW Desert Rear Bumpers

Maverick R

■ 715007172 · Black  
■ 715007694 · Yellow

\$459.99



- Rugged design.
- Provides added protection to the rear of the unit without sacrificing the agility and performance of the vehicle.
- Gives riders extra grip on the bumper and improves accessibility to rear cargo.
- Made of heavy-duty steel profile tubing.
- Inside and outside anti-corrosion coating with durable powder coat finish.
- Combine with the Rock Sliders and Front Bumper for ultimate protection.

## Rock Sliders

### NEW Rock Sliders

Maverick R

■ 715007170 · Black  
■ 715007693 · Yellow

\$529.99



- Protect the vehicle's sides against obstacles.
- With added grip on top to improve accessibility to the roof cargo.
- Made of unique heavy-duty steel profile tubing.
- Inside and outside anti-corrosion coating with durable powder coat finish.
- Combine with the Front and Rear Bumpers for ultimate protection.
- Sold in pairs.

### NEW HMW-HDPE Rock Sliders

Maverick R

715008142

\$359.99



- The sleek design gives the vehicle a sportier look.
- Tight integration with the unit's body to provide maximum obstacle clearance and outstanding protection.
- Made of combination of HMWPE and HDPE for extra durability.
- Add the Dune Front Bumper for ultimate protection and integrated lights for optimal visibility.
- Sold in pairs.

## Intrusion Bar

### NEW Front Intrusion Bar

Maverick R

715007312

\$449.99



- The steel intrusion bar matches the vehicle's styling and enhances its visual impact.
- The tube's design doesn't obstruct the rider's line of sight, and reduces blind spots for increased visibility.
- Inside and outside anti-corrosion coating with durable powder coat finish.
- Compatible with the 40" (102 cm) Baja Designs OnX6 A-LED Light Bar (71006818) and SMART Integrated LED Roof Light (715007322).
- Compatible with all windshield.

# LinQ EASY ON, EASY OFF CARGO



## MAVERICK R LinQ ACCESSORIES

### Mounting location and requirements

|   |  |   |                                 |                                  |
|---|--|---|---------------------------------|----------------------------------|
| <ul style="list-style-type: none"> <li>• No tools needed: Quickly install and remove accessories by hand</li> <li>• Equip your Can-Am for specialized tasks in no time</li> <li>• Sturdy mounting system that holds up to the roughest terrain</li> </ul> |  | Standard Cargo Bed  | LinQ Pivoting Rack<br>715007306 | Adventure Roof Rack<br>715007186 |
| <b>LinQ Accessories with 16" Base</b>   |  | <ul style="list-style-type: none"> <li>• LinQ anchors mounted 16 inches apart, center-to-center.</li> <li>• Lower loading capacity than the LinQ with 36" base accessories.</li> <li>• Can be used on Can-Am ATV and SxS vehicles, Can-Am Spyder and Ryk Sea-Doo watercraft and Ski-Doo snowmobiles.</li> </ul> |                                 |                                  |
| LinQ 4.2 Gal Cooler<br>295100698 White<br>219400964 Black   |  |   |                                 |                                  |
| LinQ Tool Kit<br>715006829  |  |   |                                 |                                  |
| LinQ Tool Box<br>715008111  |  |   |                                 |                                  |
| LinQ SR 5.5 Gal (21 L) Bag<br>860202449   |  |   |                                 |                                  |
| LinQ 4.5 Gal (17 L) Sport Bag<br>860202447  |  |   |                                 |                                  |
| LinQ Modular Box<br>715005494 (10 L)<br>715007112 (20 L)<br>715006830 (30 L)  |  |   |                                 |                                  |
| LinQ Roll-Top Bag<br>715008110  |  |   |                                 |                                  |
| <b>LinQ Accessories with 36" Base</b>   |  | <ul style="list-style-type: none"> <li>• Mount on LinQ racks often used by Can-Am ORV vehicles.</li> <li>• Higher loading capacity than the LinQ with 16" base accessories.</li> <li>• Usage is limited to Can-Am ORV vehicles.</li> </ul>  |                                 |                                  |
| LinQ Cargo Box (53L)<br>715006997   |  |   |                                 |                                  |
| LinQ Low Profile Box (63L)<br>715007827   |  |   |                                 |                                  |
| LinQ Cargo Basket (90L)<br>715005274  |  |   |                                 |                                  |
| LinQ 9.2 Gal (35L) Cooler<br>715006998  |  |   |                                 |                                  |
| <b>LinQ Cargo Accessories</b>   |  |   |                                 |                                  |
| LinQ Trunk Box (96L)<br>715007182   |  |   |                                 |                                  |
| LinQ Side Cargo Boxes (13.5L)<br>715007372  |  |   |                                 |                                  |
| <b>LinQ Holders</b>   |  |   |                                 |                                  |
| LinQ Gear Grips<br>715005340  |  |   |                                 |                                  |
| LinQ Tool Holder<br>715007358   |  |   |                                 |                                  |

## LinQ Accessories with 16" Base

### LinQ Modular Box

Maverick R

715005494 · (10 L)

\$139.99

715007112 · (20 L)

\$159.99

715006830 · (30 L)

\$179.99



- Allows stacking of other modular boxes to always have the right gear accessible.
- Always have the right box size to fit everything.
- Can be installed on any LinQ base with a 16" width.
- See table for installation location and requirements.

### Thermal Insert for LinQ Modular Box (10 L)

Maverick R

219401110

\$55.99



- Insulated liner.
- Fits very well in the LinQ Modular Box (10 L).
- Can contain seven 355 ml cans.
- Keeps ice cold for one day.
- Interior dimensions: 9" L x 17" W x 2" H.

### LinQ Tool Box

Maverick R

715008111

\$174.99



- High precision injected HDPE construction provides rigidity and durability.
- 5 gal (19 L) maximum capacity.
- Weather-resistant, sealed and lockable cover.
- Easy one-second on/off toolless system.
- All the benefits of LinQ - simple, fast and secure.
- See table for installation location and requirements.

### LinQ Tool Kit

Maverick R

715006829

\$309.99



- Includes:
  - Cutter pliers
  - Long-nose pliers
  - Locking pliers
  - Ratchet wrench 1/2" drive
  - 6" ratchet extension
  - Integrated CVT belt storage location (belt not included)
  - Long-socket 19 mm 1/2" drive - 6 pts
  - Socket 18 mm 1/2" drive
  - Long-socket 17 mm 1/2" drive - 6 pts
  - Socket 15 mm 1/2" drive
  - Socket 13 mm 1/2" drive
  - Socket 10 mm 1/2" drive
  - Socket 8 mm 1/2" drive
  - Combined wrench 19 mm
  - Combined wrench 18 mm
  - Combined wrench 15 mm
  - Combined wrench 13 mm
  - Combined wrench 10 mm
  - Combined wrench 8 mm
  - Socket Torx T30 1/2" drive
  - Socket Torx T20 1/2" drive
  - Breaker bar 1/2" drive
- See table for installation location and requirements.

### LinQ 4.2 Gal (16 L) Cooler

Maverick R

■ 219400964 · Black  
■ 295100698 · White

\$369.99



- All the benefits of LinQ - simple, fast and secure.
- Rotomolded construction for exceptional rigidity and durability.
- Premium quality foam insulation for optimal ice retention.
- Uses LinQ mounting system (patent US 8777531 and US 8875830).
- Easy one-second on/off toolless system.
- Can contain twenty 355 ml cans.
- Keeps ice cold for three days.
- Exterior dimensions: 13" L x 20" W x 10" H.
- Interior dimensions: 9" L x 17" W x 7" H.
- See table for installation location and requirements.

### LinQ 4.5 Gal (17 L) Sport Bag

Maverick R

860202447

\$204.99



- 17-liter (4.5 US gal, 1.037 cu. in.) capacity.
- Rigid bottom, semi-rigid top.
- See table for installation location and requirements.

|                                   |            |           |          |
|-----------------------------------|------------|-----------|----------|
| <b>SR 5.5 Gal (21 L) LinQ Bag</b> | Maverick R | 860202449 | \$224.99 |
|-----------------------------------|------------|-----------|----------|



- All the benefits of LinQ – simple, fast and secure.
- Semi-rigid expandable bag.
- 5.5 gal (21 L) capacity.
- Utilizes LinQ mounting system (Patent US 8777531 and US 8875830).
- Easy one-second on/off toolless system.
- See table for installation location and requirements.

|                          |            |           |          |
|--------------------------|------------|-----------|----------|
| <b>LinQ Roll-Top Bag</b> | Maverick R | 715008110 | \$229.99 |
|--------------------------|------------|-----------|----------|



- Fully waterproof roll-top dry bag will securely store and confine your equipment.
- LinQ mounted using heavy-duty rigid plastic base.
- High capacity storage solution (40 L).
- Bottom foam liner for additional equipment protection.
- Integrated handle for easy transportation on/off the vehicle.
- Dimensions: 14" L x 19" W x adjustable H.
- See table for installation location and requirements.

## LinQ Accessories with 36" Base

|                                       |            |           |          |
|---------------------------------------|------------|-----------|----------|
| <b>NEW LinQ 9.2 Gal (35 L) Cooler</b> | Maverick R | 715006998 | \$599.99 |
|---------------------------------------|------------|-----------|----------|



- LinQ mounted for efficient and secure storage, locked in place with only a quarter turn.
- Easy to install, easy to remove using the LinQ system.
- Installation in LinQ 36" configuration.
- Made of polyethylene for exceptional rigidity and durability.
- Storage capacity of 35 L.
- Lock the cooler on the vehicle using the LinQ Lock (860201968).
- Premium-quality foam insulation for optimal ice retention.
- Option to add a 5-slot LinQ Lite Rail on the side and at the rear of the cooler.
- A dry basket is included to protect your food from water.
- Drain plug at the bottom to get rid of excess water.
- The new ergonomic and resistant latch system ensures the top is tightly sealed.
- Innovative way to hold 12 cans (355 mL).
- Molded-in handles for quick installation and removal.

|                              |            |           |          |
|------------------------------|------------|-----------|----------|
| <b>LinQ Cargo Box (53 L)</b> | Maverick R | 715006997 | \$399.99 |
|------------------------------|------------|-----------|----------|



- Made of polyethylene.
- Storage capacity of 14 gal (53 L).
- Easy to install and remove with the LinQ system.
- New ergonomic and resistant latch system offers excellent sealing.
- Possibility to install LinQ 16" accessories on the cover and increase the cargo capacity.
- Ability to install Tool Holders (715008896) on the box.
- Lockable with a lock on the front of the box (2 keys included).

|  |            |           |          |
|--|------------|-----------|----------|
| <b>NEW LinQ Low Profile Box (63 L)</b> | Maverick R | 715007827 | \$399.99 |
|--|------------|-----------|----------|



- Made of impact-resistant injected polypropylene and weatherproof, this box has a storage capacity of 63 L.
- LinQ mounted for efficient and secure storage, it is locked in place with only a quarter turn. Easy to install, easy to remove using the LinQ system.
- Can be installed in several 16" configurations, or in a 36" configuration.
- LinQ 16" accessories can be installed on the cover to increase cargo capacity.
- Easily carried with the rigid handle. The antivibration system prevents the handle from moving while riding.
- Support feet at hinge level so the box can stand on its own.
- The compact design allows for maximum rear field of vision.
- Features a lock on the front of the box (two keys included).

|                                 |            |           |          |
|---------------------------------|------------|-----------|----------|
| <b>LinQ Cargo Basket (90 L)</b> | Maverick R | 715005274 | \$239.99 |
|---------------------------------|------------|-----------|----------|



- Made of polyethylene.
- Storage capacity of 23 gal (90 L).
- Easy to install and remove with the LinQ system.
- Can already be installed on your vehicle thanks to the stock mounted LinQ anchor.
- 6 handles on the contour to easily install bungee cords.
- Ability to install Tool Holders (715008896) on the basket.



## LinQ Cargo Accessories

### NEW LinQ Trunk Box (96 L)

Maverick R

715007182

\$479.99



- Weatherproof box made of impact-resistant injected polypropylene reinforced with glass fiber.
- Features a maximum storage capacity of 96 L and 15 kg.
- Easy to install, easy to remove with the LinQ system.
- Can already be installed on your vehicle thanks to the stock mounted LinQ anchor.
- Ability to install in conjunction with the LinQ Side Cargo Boxes (13.5 L) for a complete cargo solution.
- Compatible with the Pivoting Rack.

### NEW LinQ Side Cargo Boxes (13.5 L)

Maverick R

715007372

\$349.99



- Weatherproof box made of impact-resistant injected polypropylene reinforced with glass fiber.
- Features a maximum storage capacity of 13.5 L each and 5 kg.
- Easy to install, easy to remove thanks to the LinQ system.
- Possibility of installing up to two LinQ 16" accessories between the LinQ Side Cargo Boxes (13.5 L).
- Ability to install in conjunction with the LinQ Trunk Box (96 L) for a complete cargo solution.
- Compatible with the Pivoting Rack.

## LinQ Holders

### LinQ Tool Holder

Maverick R

715007358

\$54.99



- Ultra-versatile toolholder.
- Convenient swivel latch allows tools to be stored in any orientation.
- Sold in pairs.

### LinQ Gear Grips

Maverick R

715005340

\$144.99



- Durable and flexible grips provide a custom fit for a variety of items from 1" to 4" (2.5 cm to 10 cm) in diameter.
- Heavy-duty design for carrying bows, fishing poles, rakes, farm tools and more.
- Quick-release button opens grip quickly for easy access to gear.
- Heavy-duty base system built for the toughest adventures.
- Make transporting your tools a snap by combining the LinQ Gear Grips with the LinQ system.
- 360° orientation.
- Sold in pairs.

## LinQ Mounting

### LinQ Adaptor

Maverick R

715003058

\$34.99



- Sold in pack of 4.
- Allows the installation of the LinQ Tool Holder on the Adventure Roof Rack.

### LinQ Base Installation Kit

Maverick R

715008125

\$29.99



- Unique mounting fastener usable on any LinQ system accessory.
- Included: 2 Cargo LinQ bases and hardware.

### LinQ Lock

Maverick R

860201968

\$61.99



- Simple way to securely lock most LinQ accessories.
- Lock cover protects lock from the elements.
- Corrosion resistant.
- Pack of 1, includes 2 keys.
- Not compatible with LinQ 4.2 US Gal (16 L) Cooler, LinQ ToolBox, LinQ ToolHolder or LinQ Gear Grips.

|                                     |            |           |         |
|-------------------------------------|------------|-----------|---------|
| <b>Spare Tire Ratchet Tie-Downs</b> | Maverick R | 280000955 | \$32.99 |
|-------------------------------------|------------|-----------|---------|



- 3-way ratcheting tie-down strap with loop ends.
- Designed to securely hold spare tires on accessories equipped with integrated spare tire attachment points.
- Adjustable to accommodate most common on UTV tire sizes.
- Ratchet and junction ring made of durable zinc-plated steel.
- Required for spare tire attachment on Adventure Roof Rack.

# RACKS & STORAGE



## Racks

|                               |            |           |          |
|-------------------------------|------------|-----------|----------|
| <b>NEW LinQ Pivoting Rack</b> | Maverick R | 715007306 | \$849.99 |
|-------------------------------|------------|-----------|----------|



- Strong and durable, the LinQ Pivoting Rack helps keep cargo securely in place.
- Anti-corrosion coating with durable powdercoat finish.
- Gas cylinder pivot action, locks in the open position.
- Possibility of installing up to three LinQ 16" accessories on top of the rack.
- Compatible with LinQ accessories for installation under the rack.
- Features anchor points for the spare-tire attachment.
- Spare Tire Tie-Downs sold separately.

|                                |            |           |          |
|--------------------------------|------------|-----------|----------|
| <b>NEW Adventure Roof Rack</b> | Maverick R | 715007186 | \$719.99 |
|--------------------------------|------------|-----------|----------|



- The ideal cargo solution. Pack all the gear you need to take on any offroad experience.
- Built using lightweight 1.25" (3.2 cm) diameter steel tubing.
- Supports loads of up to 75 lb (34 kg).
- This roof rack features a height adjustment setting to precisely accommodate a stock roof or a roof with Cold Air Roof Scoop.
- Integrated mounting points for lights.
- Features anchor points for a spare tire attachment.
- Can be completed with LinQ Adaptor (715003058) on the side.
- The Spare Tire Tie-Downs sold separately.
- Sport roof is required for installation.

## Storage

|                                 |            |           |          |
|---------------------------------|------------|-----------|----------|
| <b>NEW Shoulder Storage Bag</b> | Maverick R | 715007371 | \$129.99 |
|---------------------------------|------------|-----------|----------|



- This weather-resistant bag holds your gear safely and securely while you ride.
- Attach the bag between the seats to maximize unused space and increase the vehicle's cargo capacity.
- This bag has a 1.5 gal (6 L) capacity and is equipped with outer netting compartments and a flexible inner net to hold items in place.
- The thermoformed base attaches to the doors, allowing the bags to be installed.
- Its soft construction makes the bag flexible enough to fit odd-shaped bags.

|                                 |            |           |          |
|---------------------------------|------------|-----------|----------|
| <b>NEW Overhead Storage Bag</b> | Maverick R | 715007379 | \$159.99 |
|---------------------------------|------------|-----------|----------|



- This weather-resistant bag holds your gear safely and securely while you ride.
- Makes smart use of the overhead space and increases the vehicle's cargo capacity by 2.3 gal (9 L).
- The thermoformed base attaches to the roof for easy bag installation and the soft construction makes the bag flexible enough to fit oddly shaped bags.
- Features a hanging function for easier access to the items in the bag and an integrated net for even more storage space.
- Contains two sections: a fixed bag and a detachable bag that can be carried.
- Easily access your smartphone using the touchscreen-compatible clear front pocket.

|                                    |            |           |          |
|------------------------------------|------------|-----------|----------|
| <b>NEW Upper Door Storage Bags</b> | Maverick R | 715008065 | \$149.99 |
|------------------------------------|------------|-----------|----------|



- These weather-resistant bags hold your gear safely and securely while you ride.
- The Door Bags fit in the upper door opening to increase your vehicle's cargo space.
- Each bag is designed as a 1.3 gal (6 L) capacity pocket and is equipped with inner netting compartments.
- The thermoformed base attaches to the doors, allowing the bags to be installed.
- Its soft construction makes the bag flexible enough to fit odd-shaped bags.
- Added elbow cushions for extra comfort.
- Sold in pairs.

**NEW Lower Door Storage Bags**

Maverick R

715007324

\$149.99



- These weather-resistant bags hold your gear safely and securely while you ride.
- The DoorBags fit in the lower door opening to increase the vehicle's cargo space.
- Each bag is designed as a 1.3 gal (5 L) capacity pocket and equipped with inner netting compartments.
- The thermoformed base attaches to the doors, allowing the bags to be installed.
- Its soft construction makes the bag flexible enough to fit odd-shaped loads.
- Added cushions for extra comfort.
- Sold in pairs.
- Not compatible with DoorSpeakers (Level 5 Audio System).

**NEW Passenger Storage Seat Bag**

Maverick R

715008080

\$249.99



- This weather-resistant bag holds your gear safely and securely while you ride.
- Bag settles on the passenger seat to increase the vehicle's cargo capacity.
- This bag features a 14.5 gal (55 L) storage capacity and is divided into two compartments.
- The top compartment is insulated to keep your beverages cold and includes two cup holders.
- Additional pocket inside for additional storage, such as a cellphone.
- The bottom compartment is accessible from both sides and serves as a large pocket for storing various items.
- The detachable pocket at the front of the bag can be used as a garbage bag.

**NEW Back Panel Storage Net**

Maverick R

715008312

\$39.99



- Storage net behind the passenger seat for more storage.

**NEW Bed Side Doors**

Maverick R

715009154

\$119.99



- Creates a storage solution out of the rear bed cavities of the unit.
- Perfect for housing trail and safety items that remain on the vehicle.
- Includes two Bed Side Doors, one for each side.

# INTELLIGENCE MEETS ACCESSORIES

Maximize your riding experience with live ECU information from your vehicle.

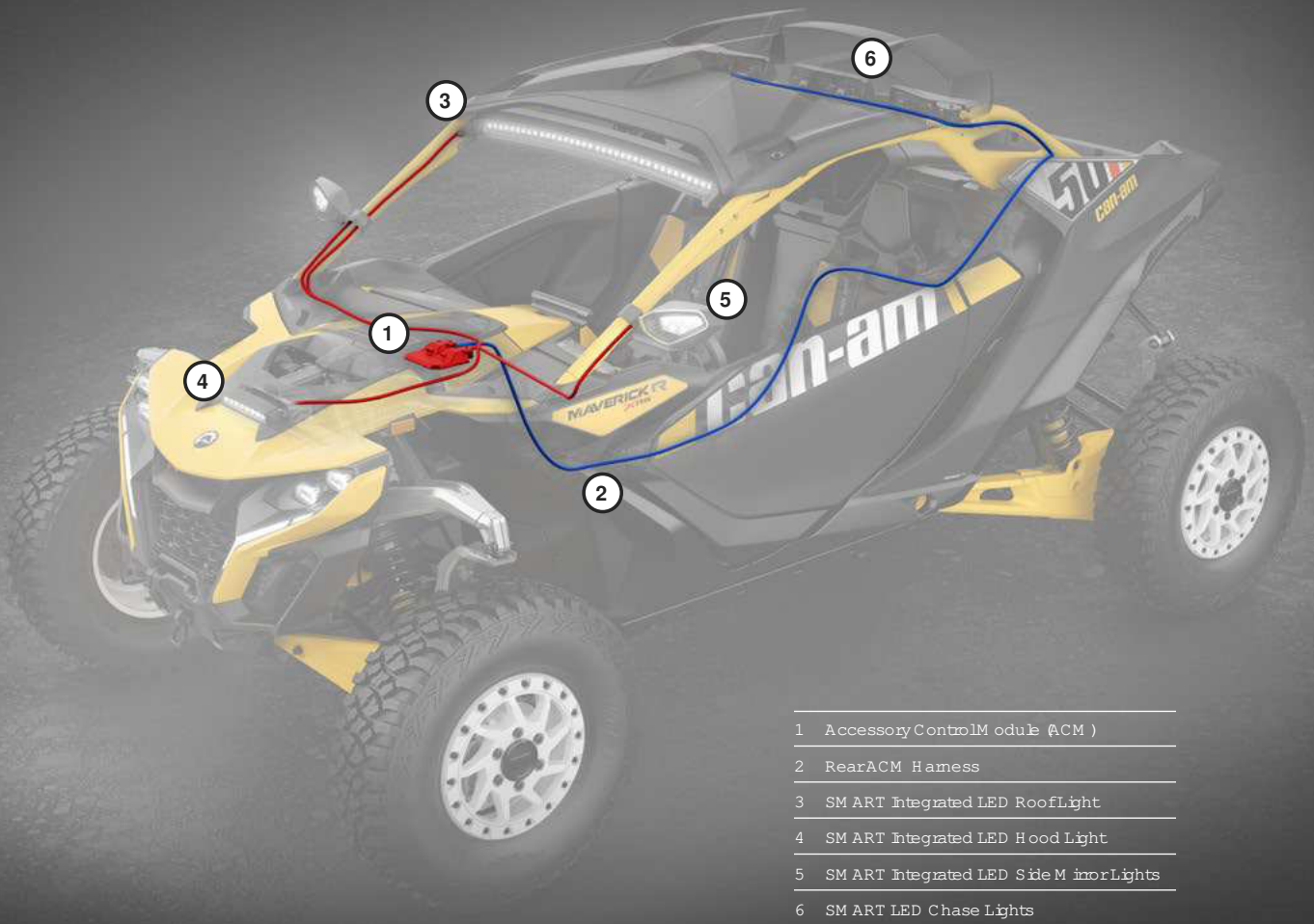

## Can-Am SM ART Accessories are an industry first!

Driven by the Can-Am ACM (Accessory Control Module), the SM ART accessories react to sensors in the vehicle. For example, lights change from Flood to Spot when you speed, and follow a curve's direction based on steering input.



# ACM & SMART ACCESSORIES



## Accessory Control Module (ACM)

|                                     |            |           |          |
|-------------------------------------|------------|-----------|----------|
| <b>NEW</b> Accessory Control Module | Maverick R | 715009796 | \$849.99 |
|-------------------------------------|------------|-----------|----------|



- Bringing the SMART to accessories using the vehicle ECU information to maximize your accessory experience.
- Connect your accessories to the 10.25" Color Touchscreen Display.
- Easy accessory installation (plug and play).
- Creates an ecosystem that makes installing accessories quicker and easier.
- Includes ACM Front Harness to connect front-mounted SMART accessories to the Accessory Control Module (two auxiliary connectors available).
- Requires ACM Rear Harness (715009268) to connect rear-mounted SMART accessories to the Accessory Control Module.

|   |            |           |          |
|---|------------|-----------|----------|
| <b>NEW</b> Rear ACM Harness<br><i>(Not Illustrated)</i> | Maverick R | 715009268 | \$449.99 |
|---|------------|-----------|----------|

- Required to connect rear-mounted accessories and rear chase lights to the ACM.
- Creates an ecosystem that makes installing accessories quicker and easier.
- Five auxiliary connectors are available.

|   |            |           |          |
|---|------------|-----------|----------|
| <b>NEW</b> SMART Control Center for ACM | Maverick R | 715007712 | \$499.99 |
|---|------------|-----------|----------|



- Control the accessories with the selection of different modes, the illuminated hub around the button indicates the active mode.
- Icons illuminate when accessories are activated.
- Make accessory control changes without having to take your eyes off the trail by choosing the accessory button required (quick access).
- All Front LED Off button to turn off all front lights with one click. Remembers the last programmed setups when this button is pressed again.
- 6 pre-programmed buttons (Light Bars, Power Flip Windshield, All Front LED Off, Corner Lights) and 8 programmable buttons to customize according to the accessories installed.

## SMART Accessories

|  |            |           |            |
|--|------------|-----------|------------|
| <b>NEW</b> SMART Integrated LED Roof Light | Maverick R | 715007322 | \$1,229.99 |
|--|------------|-----------|------------|



22,100 lumens

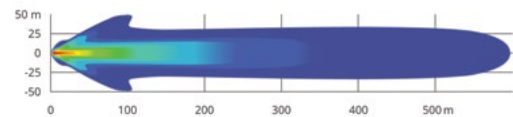

- Mounted under the roof for a signature look.
- Windshield compatible.
- Intensity varies (increases or decreases) according to the speed of the vehicle with the installation of the Accessory Control Module (ACM) (Spot/Flood ratio).
- Spot/Flood combo beam.
- 22,100 lumens.
- Off/Low/High (switch activated).
- Off/Low/High/SMART Automatic Mode (Accessory Control Module (ACM) activated).
- Accessory Control Module (715009796) is required for SMART functionality.
- Electric Harness (715008209) required to hook up and operate the Integrated LED Roof Light (715007322) for on/off function when ACM is not installed. Sold separately.

|  |            |           |          |
|--|------------|-----------|----------|
| <b>NEW</b> SMART Integrated LED Hood Light | Maverick R | 715007378 | \$349.99 |
|--|------------|-----------|----------|



5,250 lumens

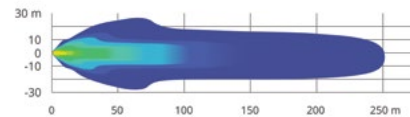

- Mounted flush inside the hood scoop for a signature look.
- Intensity varies (increases or decreases) according to the speed of the vehicle with the installation of the Accessory Control Module (ACM) (Spot/Flood ratio).
- Spot/Flood combo beam.
- 5,250 lumens.
- Off/Low/High (switch activated).
- Off/Low/High/SMART Automatic Mode (Accessory Control Module (ACM) activated).
- Accessory Control Module (715009796) is required for SMART functionality.
- Wiring harness required for on/off function when ACM is not installed. Sold separately.

**NEW SMART Integrated LED Side Mirror Lights**

Maverick R

715007185

\$319.99

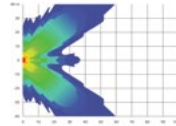

- Light up corners.
- Increase the width of the beams and illuminate the wheels for increased visibility.
- Wide flood beam.
- 3,000 lumens for each light.

- Left & right dynamic lighting with Accessory Control Module (ACM) install. Follow steering wheel input.
- Accessory Control Module (715009796) is required for SMART functionality.
- Wiring harness required for on/off function when ACM is not installed. Sold separately.
- Require Aluminum Side Mirrors (715007363).
- Electric Harness required (715008212) to hook up and operate the Integrated LED Side Mirror Lights for on/off function when ACM is not installed. Sold separately.

**NEW SMART LED Chase Lights**

Maverick R

715007727

\$659.99



- Designed by Can-Am to make you visible to vehicles riding behind you, especially in dusty or harsh conditions.
- Four modes available:
  - Trail Mode: serves as a tail light and as a brake light.
  - Chasing Mode: displays amber light pattern and serves as a brake light.
  - Work Mode: white light to light up your cargo bed.
  - Reverse Mode (when connected with Accessory Control Module (ACM)): serves as a backup light.

- Modular to allow installation with rear roll cage mounted accessories.
- Plug-and-play installation with the Accessory Control Module (ACM).
- Accessory Control Module (715009796) and Rear ACM Harness (715009268) are required for SMART functionality.
- Electric Harness (715008210) required to hook up and operate the LED Chase Lights (715007727) for a non-smart function when ACM is not installed.

**Intermittent Wiper & Washer Kit**

Maverick R

715007173

\$699.99



- An ideal way to keep your windshield clear in the rain, or while riding through mud and water.
- The wiper mechanism and washer fluid dispenser are perfectly concealed on the vehicle.
- The wiper and washer fluid dispenser installs at the bottom of the windshield for maximum visibility.

- For use on Glass or Hardcoated Windshields.
- Intermittent wiper speed feature available when the kit is installed in combination with ACM.
- Electric Harness (715008855) required to hook up and operate the Wiper & Washer Kit (715007173) for on/off function when ACM is not installed.

# LIGHTS



## SMART Lights

| SMART LIGHTS WHEN ACM IS INSTALLED     |  |  |   |   |
|--|--|--|---|---|
| SMART functionality                    | SMART Integrated LED Roof Light<br>715007322                       | SMART Integrated LED Hood Light<br>715007378 | SMART Integrated LED Side Mirror Lights<br>715007185  | SMART LED Chase Lights<br>715007727   |
|  | Accessory Control Module (ACM) with Front ACM Harness<br>715009796 |  | Aluminum Side Mirrors<br>715007363<br>+<br>Accessory Control Module (ACM) with Front ACM Harness<br>715009796 | Accessory Control Module (ACM)<br>715009796<br>+<br>Rear ACM Harness<br>715009268 |
| SMART LIGHTS WHEN ACM IS NOT INSTALLED |  |  |   |   |
| ON/OFF functionality                   | SMART Integrated LED Roof Light<br>715007322                       | SMART Integrated LED Hood Light<br>715007378 | SMART Integrated LED Side Mirror Lights<br>715007185  | SMART LED Chase Lights<br>715007727   |
|  | Wiring Harness<br>715008209  | Wiring Harness<br>715008211                  | Aluminum Side Mirrors<br>715007363<br>+<br>Wiring Harness<br>715008212  | Wiring Harness<br>715008210   |

\*All lights are intended for off-road use only.

# BAJA Lights

|  |   | 2 Choose your lights   |   |   |   |   |
|--|---|--|---|---|---|---|
| 1 Choose your mount point                              |   | BAJA LIGHTS WHEN ACM IS INSTALLED  |   |   |   |   |
|  |   | 40" (102 Cm) Baja Designs OnX6 Arc LED LightBar<br>710006818   | 10" (25 Cm) Baja Designs OnX6 LED LightBar<br>710006819 | Baja Designs XL Sport LED Lights<br>710006821 | Baja Designs Squadron Sport LED Lights<br>710004648 | Baja Designs XL80 LED Lights<br>710005041 |
| Desert Front Bumper<br>(715007311 or 715007691)        | N/A                                       |  | LED LightBars<br>ACM Adaptor<br>715008213               | LED Lights<br>ACM Adaptor<br>715007715        | LED Lights<br>ACM Adaptor<br>715007715              | LED Lights<br>ACM Adaptor<br>715007715    |
| Trail Front Bumper<br>(715007803 or 715008763)         | N/A                                       |  | N/A   |   |   |   |
| Roof with Light Support Bar<br>(715003529)             | N/A                                       |  | N/A   |   |   |   |
| Roof Light Mounting Kit<br>- Low Position (715008585)  | LED LightBars<br>ACM Adaptor<br>715008213 |  | N/A   | N/A   | N/A   | N/A                                       |
| Roof Light Mounting Kit<br>- High Position (715007930) |   |  | N/A   | N/A   | N/A   | N/A                                       |
|  |   | 2 Choose your lights   |   |   |   |   |
| 1 Choose your mount point                              |   | BAJA LIGHTS WHEN ACM IS NOT INSTALLED  |   |   |   |   |
|  |   | 40" (102 Cm) Baja Designs OnX6 Arc LED LightBar<br>710006818   | 10" (25 Cm) Baja Designs OnX6 LED LightBar<br>710006819 | Baja Designs XL Sport LED Lights<br>710006821 | Baja Designs Squadron Sport LED Lights<br>710004648 | Baja Designs XL80 LED Lights<br>710005041 |
| Desert Front Bumper<br>(715007311 or 715007691)        | N/A                                       |  | Wiring Harness<br>715008863                             | Wiring Harness<br>715008865                   | Wiring Harness<br>715008865                         | Wiring Harness<br>715008865               |
| Trail Front Bumper<br>(715007803 or 715008763)         | N/A                                       |  | N/A   |   |   |   |
| Roof with Light Support Bar<br>(715003529)             | N/A                                       |  | Wiring Harness<br>715008863                             |   |   |   |
| Roof Light Mounting Kit<br>- Low Position (715008585)  | Wiring Harness<br>715008864               |  | N/A   | N/A   | N/A   | N/A                                       |
| Roof Light Mounting Kit<br>- High Position (715007930) |   |  | N/A   | N/A   | N/A   | N/A                                       |
| 3 Order  |   | Order all part numbers in intersecting box<br><i>*Note: When installing more than one light kit, additional light power cable or mounting kit is required.</i> |   |   |   |   |

All lights are intended for off-road use only.

|  |            |           |            |
|--|------------|-----------|------------|
| 40" (102 cm) Baja Designs OnX6 Arc LED Light Bar | Maverick R | 710006818 | \$2,089.99 |
|--|------------|-----------|------------|



29,000 lumens

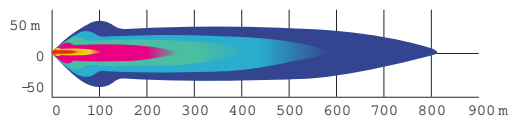

- 252 W lightbar producing 29,000 lumens.
- Equipped with 24 Cree XM-L2 LEDs.
- Driving/Combo light pattern for smooth blend of light for both near field applications and distance.
- Designed for installation onto Light Support Bars equipped roofs.
- Requires Light Power Cable and Light Support Bar.
- ACM Adaptor required (715008213) to connect the Baja Designs LED Light Bars to the ACM harness.
- Electric Harness (715008864) required to hook up and operate the 40" (102 cm) Baja Designs OnX6 Arc LED Light Bar (710006818) for on/off function when ACM is not installed.
- Baja Designs Light Mounting Kit (715007930 or 715008585) is required for installation.
- See table for installation location and requirements.

|   |            |           |          |
|---|------------|-----------|----------|
| Baja Designs 10" (25 cm) OnX6 LED Light Bar | Maverick R | 710006819 | \$549.99 |
|---|------------|-----------|----------|



12,460 lumens

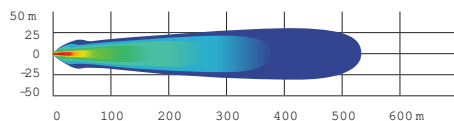

- 108 W lightbar producing 12,460 lumens.
- Equipped with 6 Cree XM-L2 LEDs.
- Driving/Combo light pattern for smooth blend of light for both near field applications and distance.
- Dual intensity (high/low) settings.
- Requires Baja Designs Light Power Cable.
- ACM Adaptor required (715008213) to connect the Baja Designs LED Light Bars to the ACM harness.
- Electric Harness (715008863) required to hook up and operate the 10" (25 cm) Baja Designs OnX6 LED Light Bar (710006819) for on/off function when ACM is not installed.
- See table for installation location and requirements.

**Baja Designs XL80 LED Lights**

Maverick R

710005041

\$1,039.99

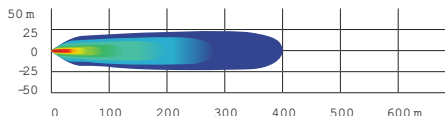

- 80 W perspot producing 9,500 lumens.
- Equipped with 4 Cree XHP50 LEDs perspot.
- Dual intensity (high/low) settings.
- Driving/combo light pattern for smooth blend of light for both near field applications and distance.
- Require Baja Designs Light Power Cable.
- Sold in pairs.

- Dimensions: 4.5" x 4.5" (11.4 cm x 11.4 cm).
- ACM Adaptor required (715007715) to connect the Baja Designs LED Lights to the ACM harness.
- Electric Harness (715008863) required to hook up and operate the Baja Designs XL80 LED Lights (710005041) for on/off function when ACM is not installed.
- See table for installation location and requirements.

**Baja Designs Squadron Sport LED Lights**

Maverick R

710006820

\$299.99

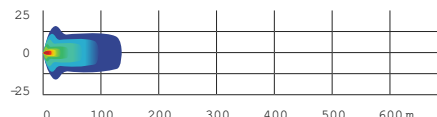

- 26 W perspot producing 3,150 lumens.
- Equipped with 4 Cree XP-G2 LEDs perspot.
- Wide coming light pattern designed specifically for coming, dust and/or fog conditions.
- Sold in pairs.

- Dimensions: 3" x 3" (7.6 cm x 7.6 cm).
- Electric Harness (715008865) required to hook up and operate the Baja Designs Squadron Sport LED Lights (710006820) for on/off function when ACM is not installed.
- See table for installation location and requirements.

**Baja Designs XL Sport LED Lights**

Maverick R

710006821

\$519.99

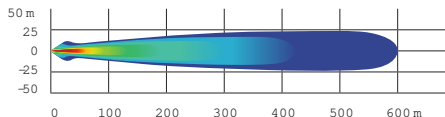

- 26 W perspot producing 3,150 lumens.
- Equipped with 4 Cree XP-G2 LEDs perspot.
- High Speed Spot features a longer and narrower beam focus for illumination farther down.
- Require Baja Designs Light Power Cable.
- Sold in pairs.

- Dimensions: 4.5" x 4.5" (11.4 cm x 11.4 cm).
- ACM Adaptor required (715007715) to connect the Baja Designs LED Lights to the ACM harness.
- Electric Harness (715008865) required to hook up and operate the Baja Designs XL Sport LED Lights (710006821) for on/off function when ACM is not installed.
- See table for installation location and requirements.

**NEW Baja Designs Light Mounting Kit - High Position**

Maverick R

715007930

\$149.99



- Mounting system for 40" (102 cm) Baja Designs OnX6 A/C LED Light Bar.
- Compatible with the Cold Air Roof Scoop.

**NEW Baja Designs Light Mounting Kit - Low Position**

Maverick R

715008585

\$119.99



- Mounting system for 40" (102 cm) Baja Designs OnX6 A/C LED Light Bar.
- Not compatible with the Cold Air Roof Scoop.





# AMPLIFYING THE MAVERICK EXPERIENCE WITH JL AUDIO

## AUDIO SYSTEMS



**NEW Can-Am JL Audio System - Level 5** | Maverick R | **715007957** | **\$5,099.99**



- Orchestrated for outstanding sound quality and calibrated to enhance your audio experience.
- Designed to fit the vehicle perfectly for a fully integrated look.
- Designed to be Can-Am tough in the most demanding riding conditions.
- Controlled by the 10.25" Color Touchscreen Display or by the Can-Am JL Audio Source Unit.
- Made using premium JL Audio components, including six 6.5" (165 mm) speakers (two dash, two door, and two surround speakers), as well as two 10" (254 mm) under-seat 250 W subwoofers that will enhance both the driver's and the passenger's experience.
- Uses one MX500/4 to power up our six speakers, and one MX500/1 to feed the under-seat subwoofers.
- Complements the Can-Am Audio Roof - Level 4 (715007309).

**NEW Can-Am JL Audio Roof - Level 4** | Maverick R | **715007309** | **\$3,499.99**



- Full roof with premium JL Audio System for Maverick R.
- Features fully sealed and waterproof components and construction.
- Easy to install and connect.
- Controlled by the 10.25" Color Touchscreen Display or by the Can-Am JL Audio Source Unit.
- Its weatherproof components include four 7.7" coaxial speakers and a 500-watt amplifier.
- The system is expertly tuned for exceptional sound when you're riding in your Maverick R.
- Speakers include an adjustable RGB LED cone illumination, controlled via an app on your smartphone.
- Specific to your type of riding.
- When combined with the Can-Am Audio System - Level 3 (715007954) or Level 5 (715007957), it provides the ultimate sound experience.
- Not compatible with the Adventure Roof Rack (715007186).

**NEW Can-Am JL Audio System - Level 3** | Maverick R | **715007954** | **\$3,599.99**



- Orchestrated for outstanding sound quality and calibrated to enhance your audio experience.
- Designed to fit the vehicle perfectly for a fully integrated look.
- Designed to be Can-Am tough in the most demanding riding conditions.
- Controlled by the 10.25" Color Touchscreen Display or by the Can-Am JL Audio Source Unit.
- Made using premium JL Audio components, including four 6.5" (165 mm) speakers (two dash and two surround speakers), and a 10" (254 mm) under-seat 250 W subwoofer that will enhance both the driver's and the passenger's experience.
- Uses one MX280/4 to power up our four speakers, and one MX500/1 to power up the under-seat subwoofer.
- Easy to install, with the option to add a second subwoofer (715007310).
- Complements the Can-Am Audio Roof - Level 4 (715007309).

|  |            |           |          |
|--|------------|-----------|----------|
| <b>NEW Can-Am JL Audio Roof Flip Kit</b> | Maverick R | 715008164 | \$499.99 |
|--|------------|-----------|----------|



- Combines with the Can-Am JL Audio Roof-Level 4 (715007309) for Flip option.
- Not compatible with the Cold Air Roof Scoop and the Roof Rack.

|                                      |            |           |          |
|--------------------------------------|------------|-----------|----------|
| <b>NEW Can-Am JL Audio Subwoofer</b> | Maverick R | 715007310 | \$749.99 |
|--------------------------------------|------------|-----------|----------|



- Orchestrated for outstanding sound quality and calibrated to enhance your audio experience.
- Designed to be Can-Am tough in the most demanding riding conditions.
- Easy to install, this 10" (254 mm) under-seat 250 W subwoofer enhances both the driver's and the passenger's experience.
- When combined with the Can-Am audio system -Level 3 (715007954) or with the Can-Am audio roof-Level 4 (715007309), this premium JL Audio component creates the ultimate sound experience.
- To add a subwoofer to the Can-Am JL Audio Roof-Level 4, a Can-Am JL Audio Amplifier (715007714) is required.

|                                      |            |           |          |
|--------------------------------------|------------|-----------|----------|
| <b>NEW Can-Am JL Audio Amplifier</b> | Maverick R | 715007714 | \$649.99 |
|--------------------------------------|------------|-----------|----------|



- Orchestrated for outstanding sound quality and calibrated to enhance your audio experience.
- Designed to fit the vehicle perfectly for a seamless integration.
- Designed to be Can-Am tough in the most demanding riding conditions.
- This MX500/1 is a premium JL Audio component, and is used to feed one or two 250 W under-seat subwoofers.
- When combined with the Can-Am Audio Roof-Level 4 (715007309), it creates the ultimate sound experience.
- To add a subwoofer to the Can-Am JL Audio Roof-Level 4, this item is required.
- Easy to install, mounting support included.

|  |            |           |          |
|--|------------|-----------|----------|
| <b>NEW Can-Am JL Audio Source Unit</b> | Maverick R | 715008230 | \$729.99 |
|--|------------|-----------|----------|



- Required with all Can-Am Audio JL levels installed on vehicles without 10.25" Cobra Touchscreen Display.
- Designed to fit the vehicle perfectly for a fully integrated look.
- AM /FM /Bluetooth compatible.

## ELECTRICAL & ELECTRONIC ACCESSORIES



|                                     |            |           |          |
|-------------------------------------|------------|-----------|----------|
| <b>NEW Electronic Device Holder</b> | Maverick R | 715007176 | \$319.99 |
|-------------------------------------|------------|-----------|----------|



- Increases the storage capacity of the glovebox by 1 gal (4 L), with secure magnetic adjustable support for your electronic device.
- Robust injected fiber-reinforced polypropylene construction allows for the right fit and easy installation.
- Magnet 10 times stronger than any electronic device's weight, ride through rough terrain confidently.
- 2 possible positions for your electronic device: Portrait & Landscape. Adjustable support with 2 positions: facing the passenger or toward the pilot for an improved driving experience and immersion.
- Includes everything needed for installation on your favorite electronic devices: 2 pre-assembled Can-Am plates with 3M multi-surface adhesive.

|                             |            |           |         |
|-----------------------------|------------|-----------|---------|
| <b>NEW Cellphone Holder</b> | Maverick R | 715008786 | \$99.99 |
|-----------------------------|------------|-----------|---------|



- Water-resistant door allows for perfect phone positioning.
- Features capacitive and resistive touch screen technology.
- Spring system in back plate automatically adjusts for thickness.
- Fits all cellphones within 7.2" (185 mm) x 3.3" (85 mm) x 0.6" (15 mm) dimensions.
- Works with almost all charger wires.
- Does not include cellphone or charging wires.
- Requires the Electronic Device Holder (715007176) for the Cellphone Holder to be supported.

|  |   |           |         |
|--|---|-----------|---------|
| <b>Color Touchscreen Display Protector</b> | Vehicle equipped with 10.25 in. Cobra Touchscreen Display | 860202680 | \$25.99 |
|--|---|-----------|---------|



- Provides additional protection for the digital display 10.25 in. touchscreen.
- Protects from scratches caused by ice, rocks, branches or other small debris.
- Antiglare treatment to ensure good visibility.
- Includes cleaning tools: wet wipe, dry wipe, dust absorber and soft cloth.

**NEW Auxiliary Battery Installation Kit**

Maverick R

715007837

\$399.99

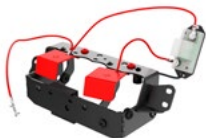

- Allows the rider to add a second battery and/or replace the original battery (18 Ah or 30 Ah) for a dual battery setup. Recommended to power auxiliary electrical components such as sound system or winches.
- Automatic shutdown protection.
- Installs behind the seat for easy access.
- Requires the purchase of a second battery and battery hardware (not included and sold separately).
- Equipped with an electronic module that prevents the auxiliary electrical components from draining the original battery.

# WINCHES



## Can-Am HD Winches

**Can-Am HD 4500 Winch**

Maverick R

715006416

\$359.99



- Ergonomic clutch handle.
- Rugged all-steel gears and bushings form core torque and durability.
- Automatic 100% load-holding brake.
- Sealed solenoid for all-weather protection.
- Weather-sealed corded remote and dash-mounted switch.
- EC compliant.
- Pulling strength capability of 4,500 lb (2,041 kg).
- 43' of 1/2" (13.1 m of 6.3 mm) wire steel cable.
- Heavy-duty 4-way roller fairlead.
- Winch Electrical Harness (715008850), Winch Roller Fairlead Spacer (715008922) and winch compatible front bumper are required.

**Can-Am HD 4500-S Winch**

Maverick R

715006417

\$479.99



- Ergonomic clutch handle.
- Rugged all-steel gears and bushings form core torque and durability.
- Automatic 100% load-holding brake.
- Sealed solenoid for all-weather protection.
- Weather-sealed corded remote and dash-mounted switch.
- Pulling strength capability of 4,500 lb (2,041 kg).
- 50' of 1/2" (15.2 m of 6.35 mm) synthetic rope.
- Corrosion-proof aluminum hawse fairlead.
- Winch Electrical Harness (715008850) and winch compatible front bumper are required.

## WARN<sup>†</sup> VRX Winches

**WARN VRX 45 Winch**

Maverick R

715006110

\$609.99



- Extreme IP68-rated waterproof sealing keeps the elements out.
- Durable aluminum construction.
- Black powder-coated finish and stainless steel fasteners for corrosion resistance.
- Robust new clutch design based on 70+ years of WARN 4WD hub lock know-how.
- Load-holding brake for great control.
- Smooth and reliable aluminum three-stage planetary gear train.
- Dash-mounted rocker control.
- Limited lifetime warranty (mechanical), 3-year warranty (electrical).
- Pulling strength capability of 4,500 lb (2,041 kg).
- 50' of 1/2" (15 m of 6.3 mm) wire steel cable.
- Roller fairlead.
- Winch Electrical Harness (715008850), Winch Roller Fairlead Spacer (715008922) and winch compatible front bumper are required.

**WARN VRX 45-S Winch**

Maverick R

715006111

\$729.99



- Extreme IP68-rated waterproof sealing keeps the elements out.
- Durable aluminum construction.
- Black powder-coated finish and stainless steel fasteners for corrosion resistance.
- Robust new clutch design based on 70+ years of WARN 4WD hub lock know-how.
- Load-holding brake for great control.
- Smooth and reliable aluminum three-stage planetary gear train.
- Dash-mounted rocker control.
- Limited lifetime warranty (mechanical), 3-year warranty (electrical).
- Pulling strength capability of 4,500 lb (2,041 kg).
- 50' of 1/2" (15 m of 6.3 mm) synthetic rope.
- Cast aluminum hawse fairlead.
- Winch Electrical Harness (715008850) and winch compatible front bumper are required.

## Winch Accessories

|                                 |                 |                  |                |
|---------------------------------|-----------------|------------------|----------------|
| <b>Can-Am HD Hawse Fairlead</b> | Can-Am HD Winch | <b>715006426</b> | <b>\$57.99</b> |
|---------------------------------|-----------------|------------------|----------------|



- Must be used when upgrading your winch with a synthetic cable, this corrosion-proof aluminum hawse fairlead will prevent the cable from snapping in a corner of a roller fairlead and from wearing prematurely due to the rough surface of the worn roller guide.
- Must be used with synthetic cables only.

|                            |            |                  |                 |
|----------------------------|------------|------------------|-----------------|
| <b>WARN Hawse Fairlead</b> | WARN Winch | <b>715007785</b> | <b>\$109.99</b> |
|----------------------------|------------|------------------|-----------------|



- Double-powder-coated construction.
- Required to use the Synthetic Winch Cable (715001118) on WARN winches.
- To be used with synthetic winch cables only.

|   |            |                  |                |
|---|------------|------------------|----------------|
| <b>NEW Winch Roller Fairlead Spacer</b> | Maverick R | <b>715008922</b> | <b>\$69.99</b> |
|---|------------|------------------|----------------|



- Required when using a Winch and Roller Fairlead with a wire cable.
- Made of aluminum, with an anti-corrosion finish.

|                              |                 |                  |                 |
|------------------------------|-----------------|------------------|-----------------|
| <b>Synthetic Winch Cable</b> | Can-Am HD Winch | <b>715006430</b> | <b>\$149.99</b> |
|                              | WARN Winch      | <b>715007783</b> | <b>\$164.99</b> |



- 50' of 1/2" (15.2 m of 6.35 mm) synthetic cable for Can-Am HD winches.
- Can-Am HD Hawse Fairlead (715006426) is required when upgrading to a synthetic cable to avoid premature cable damage and wear.
- WARN Hawse Fairlead (715007785) is required when upgrading to a synthetic cable to avoid damage and premature wear of the cable.

|                              |                 |                  |                |
|------------------------------|-----------------|------------------|----------------|
| <b>Wire Rope Replacement</b> | Can-Am HD Winch | <b>705014978</b> | <b>\$22.49</b> |
|                              | WARN Winch      | <b>715006699</b> | <b>\$80.99</b> |



- 43' of 1/2" (14.3 m of 6.3 mm) wire rope for Can-Am HD Winch.
- 55' of 1/2" (16.8 m of 6.35 mm) wire rope for WARN winch kit.
- 4,500 lb (2,041 kg) pulling strength.

|                                  |  |                  |                 |
|----------------------------------|--|------------------|-----------------|
| <b>Synthetic Cable Extension</b> |  | <b>715001120</b> | <b>\$169.99</b> |
|----------------------------------|--|------------------|-----------------|



- Lightweight 1/2" (6.35 mm) diameter, easy to handle and won't rattle in cargo box.
- Easily attaches to winch cable to provide additional 50' (15.2 m) of distance.
- 4,500 lb (2,041 kg) single line capacity.

|   |            |                  |                 |
|---|------------|------------------|-----------------|
| <b>Winch Electrical Harness</b><br><i>(Not illustrated)</i> | Maverick R | <b>715008850</b> | <b>\$179.99</b> |
|---|------------|------------------|-----------------|

- Required for winch installation.

|                             |                  |                  |                |
|-----------------------------|------------------|------------------|----------------|
| <b>Wired Remote Control</b> | Can-Am HD Winch* | <b>715006504</b> | <b>\$24.99</b> |
|-----------------------------|------------------|------------------|----------------|



- This kit allows winch owners to add the hand-held remote to vehicles with a stock winch.
- OEM stock winch is sold separately.
- EC compliant.

† Harness (710001023) is required to use remote control on a vehicle with a factory installed winch.  
‡ Remote Control (710007050) and connection socket are included.

|                                |            |                  |                 |
|--------------------------------|------------|------------------|-----------------|
| <b>Wireless Remote Control</b> | WARN Winch | <b>715002542</b> | <b>\$214.99</b> |
|--------------------------------|------------|------------------|-----------------|



- The system is quick and easy to install, thanks to a wiring harness with an integrated antenna and all necessary mounting hardware.
- The system allows you to operate your winch from anywhere within a 50' (15.2 m) radius, increasing your recovery options.
- All components are weatherproof.



# PERFORMANCE

|  |            |           |          |
|--|------------|-----------|----------|
| <b>NEW Lonestar Racing Fire Extinguisher Support</b> | Maverick R | 715007320 | \$219.99 |
|--|------------|-----------|----------|



- Quick-release support that lets riders slide the fire extinguisher out in a matter of seconds in an emergency.
- Made of billet anodized black aluminum.
- Fits 1.85" (4.7 cm) tubing.
- Can be fixed anywhere on the cage.
- Provides riders with the safety and security of knowing they have dependable emergency equipment on board.
- Comes with both billet mounts, quick-pull pin, mounting plate and two clamps.
- Fire extinguishers sold separately.
- "Lonestar Racing for Can-Am" branded.

|   |            |           |          |
|---|------------|-----------|----------|
| <b>Performance Air Filter by Twin AIR<sup>®</sup></b> | Maverick R | 715002895 | \$109.99 |
|---|------------|-----------|----------|



- The best choice for the harshest conditions.
- Multiple staged oiled filtering foam for superior dust retaining capacity with high airflow.
- Washable and reusable.

|   |            |           |         |
|---|------------|-----------|---------|
| <b>Digitally Encoded Security System (D.E.S.S.)<br/>Green Key</b> | Maverick R | 710005232 | \$53.99 |
|---|------------|-----------|---------|



- Top-security anti-theft protection for your vehicle.
- Encrypted chip technology restricts access to your vehicle's electronic ignition system.
- One vehicle/one code.
- A vibration/shock-resistant ball-and-socket design that ensures a reliable connection.
- 3 programmable modes:
  - Work mode: Limits vehicle speed to 40 kph (25 mph) but does not limit engine torque.
  - Normal mode: Limits vehicle speed to 70 kph (44 mph) and 50% torque reduction.
  - Performance mode: No restrictions.









---

# CAN-AM COMMANDER, MAVERICK TRAIL & MAVERICK SPORT

---

CAN-AM COMMANDER,  
MAVERICK TRAIL & MAVERICK SPORT



# CAN-AM COMMANDER, MAVERICK TRAIL & MAVERICK SPORT

## COMMANDER FEATURED PACKAGES

|                        |     |
|------------------------|-----|
| 2024 Commander MAX DPS | 160 |
| 2024 Commander MAX m r | 162 |
| 2024 Commander XT 700  | 164 |

|  |     |
|--|-----|
| <b>COMMANDER<br/>COMPARATIVE CHART</b> | 166 |
|--|-----|

|  |     |
|--|-----|
| <b>MAVERICK TRAIL<br/>FEATURED PACKAGE</b> |     |
| 2024 Maverick Trail                        | 170 |

|  |     |
|--|-----|
| <b>MAVERICK TRAIL &amp;<br/>MAVERICK SPORT<br/>COMPARATIVE CHART</b> | 172 |
|--|-----|

## ACCESSORIES

|   |     |
|---|-----|
| Roofs                                       | 178 |
| Soft Cab Enclosure                          | 178 |
| Windshields & Wind Protection               | 179 |
| Mirrors                                     | 181 |
| Doors                                       | 182 |
| Seat Accessories                            | 183 |
| Commander Skid Plates                       | 184 |
| Maverick Trail & Maverick Sport Skid Plates | 185 |
| Bumpers & Guards                            | 186 |
| LinQ :Easy On, Easy Off Cargo               | 189 |
| Cargo & Storage                             | 194 |
| Racks & Holders                             | 196 |
| Lights                                      | 199 |
| Audio & Communication Systems               | 203 |
| Electrical & Electronic Accessories         | 204 |
| Winches & Hitches                           | 206 |
| Performance                                 | 208 |
| Apache Track Systems                        | 210 |
| Promount Plows                              | 213 |
| Covers                                      | 216 |







# 2024 COMMANDER MAX DPS

---



†Visco-Lok is a trademark of GKN Viscodrive GmbH.  
All other trademarks are the property of their respective owners.



Tundra Green

## Feature highlights



### Locking into Action for a Difference

The Visco-Lok® QE Quick Engagement front differential on the Can-Am Commander MAX DPS 700 comes with more grip than you could hope for. This feature turns the front differential on your vehicle into a sort of pump: the front wheels' spinning locks the feature in place quickly. Plus, with no rev or speed limiter, it delivers optimal wheel traction on every adventure.



### Get on My Lawn!

The Can-Am Commander MAX DPS 700 is the do-it-all vehicle that goes anywhere... including safely on your lawn! No need for detours with the rear differential with Turf mode on this side-by-side: as you haul food or anything you want back home, select the Turf mode to ride across your grass with little to no damage.



### Steering Clear of Issues

The Can-Am Commander MAX DPS 700 comes with Dynamic Power Steering (DPS). This high-torque technology is the stabilizing force you need to own every challenge: it's useful against external forces like strong crosswinds or uneven roads. With DPS, you ride confidently knowing you'll never veer off path.



### Two Modes, Many Riders

Do you prefer going full throttle or a more laid-back experience? With the Can-Am Commander MAX DPS 700, you don't have to choose. With SPORT and ECO™ driving modes, every rider can pick between performance and the most engaging throttle response on one side, and fuel economy and the smoothest throttle response on the other side.



### Anti-Theft Protection

A ride this special deserves heightened security. Encrypted chip technology - one vehicle, one key, one code - restricts access to only the owner. The electronic ignition system and ball-and-socket key design team up for a reliable wireless connection. Additional keys, programmed for other riders, can be added at any time.



### Trip Info at Your Fingertips

The 4.5 inch digital display keeps the Can-Am Commander DPS 700's crucial information at hand. Features include speedometer, gear position, temperature, engine lights control, electronic fuel gauge, clock and more.



### Open the Door to New Rides

Push further in a Can-Am Commander MAX DPS 700 equipped with premium half doors. At every turn, these high-quality half doors deliver better protection to keep everyone safe and sound inside the vehicle's cockpit.



### Can Things Get Too Muddy?

This do-it-all side-by-side comes equipped with mudguards to help riders dive into the gnarliest holes they come across. The curved strip or cover over the wheel of the unit is designed to protect both rider and vehicle from water and dirt that jumps in the air as you enjoy epic mud adventures.

# 2024 COMMANDER MAX XMR



 Wildland Camo

| <b>ENGINE</b>             |  |
|---------------------------|--|
| Type                      | 1000R  |
| Fuel Delivery System      | 100 hp, Rotax® 976 cc, V-twin, liquid-cooled<br>Intelligent Throttle Control (ITC™) with Electronic Fuel Injection (EFI)   |
| Transmission              | Quick Response System (QRS) CVT with high-airflow ventilation. Strategically positioned CVT air intakes and exhaust. Lower gearing ratio and Electronic Drive Belt Protection<br>Extra-L / H / N / R / P |
| Drive Train               | Lockable front differential with exclusive Smart-Lok* technology<br>True 4 modes traction system: 2WD / 4WD with front diff. lock / 4WD MUD / 4WD TRAIL  |
| Driving Assistance        | Electronic Hill Descent Control<br>SPORT / ECO™ modes  |
| Power Steering            | Dynamic Power Steering (DPS™)  |
| <b>SUSPENSIONS</b>        |  |
| Front Suspension          | Arched double A-arm with sway bar / 14 in. (35.6 cm) suspension travel   |
| Front Shocks              | Twin tube gas-charged shocks   |
| Rear Suspension           | Arched TTA with sway bar / 14 in. (35.6 cm) suspension travel  |
| Rear Shocks               | Twin tube gas-charged shocks   |
| <b>TIRES &amp; WHEELS</b> |  |
| Front / Rear Tires        | XPS Swamp Force 30 x 9 / 11 x 14 in.   |
| Wheels                    | 14 in. cast aluminum   |
| <b>BRAKES</b>             |  |
| Front / Rear              | Dual 220 mm disc brakes with hydraulic twin-piston calipers  |

## PACKAGE HIGHLIGHTS

- Smart-Lok\* front differential
- Strategically positioned engine air intake and CVT inlet / outlet
- Special edition seats
- 7.6 in. digital display with keypad
- LED headlights and Can-Am LED signature
- 64 in. wide with arched A-arm
- 30 in. XPS Swamp Force tires
- 14 in. cast-aluminum wheels
- Heavy-duty front steel bumper
- Relocated 4,500 lb (2,014 kg) winch
- Mudguard extensions

## DIMENSIONS & CAPACITIES

|                      |  |
|----------------------|--|
| Estimated Dry Weight | 2,061 lb (937 kg)                              |
| Chassis / Cage       | Profiled cage, ROPS approved                   |
| L x W x H            | 152 x 64 x 74.3 in. (386.1 x 162.6 x 188.6 cm) |
| Wheelbase            | 120.6 in. (306.3 cm)                           |
| Ground Clearance     | 13.5 in. (34.3 cm)                             |
| Cargo Box Dimensions | 29.5 x 45.2 x 10.6 in. (75.1 x 114.7 x 27 cm)  |
| Cargo Box Capacity   | 600 lb (272.2 kg)                              |
| Towing Capacity      | 2,000 lb (907.2 kg)                            |
| Payload Capacity     | 1,280 lb (580.6 kg)                            |
| Storage Capacity     | Total: 8.5 gal (32.1 L)                        |
| Fuel Capacity        | 10 gal (38 L)                                  |

## FEATURES

|                   |   |
|-------------------|---|
| Gauge             | 7.6 in. wide digital display with keypad  |
| Instrumentation   | DC outlet (10 A)  |
| Anti-Theft System | RF Digitally Encoded Security System (D.E.S.S.™) with Start / Stop button                                 |
| Magneto           | 650 W   |
| Lighting          | LED headlights<br>LED signature<br>LED tail lights  |
| Winch             | Relocated 4,500 lb (2,041 kg) winch with synthetic rope and roller fairlead                               |
| Steering Wheel    | Adjustable tilt steering  |
| Protection        | Premium half doors<br>Full skid plate<br>Mudguards / mudguard extensions<br>Heavy-duty front steel bumper |
| Hitch Type        | 2 in. hitch receiver  |

## WARRANTY & EXTENDED SERVICE

|                        |   |
|------------------------|---|
| Factory Warranty       | 6-month BRP limited warranty            |
| Extended Service Terms | B.E.S.T. term available up to 30 months |

\*Smart-Lok was developed in conjunction with TEAM Industries, a market leader in the drive train industry. All other trademarks are the property of their respective owners.





 Wildland Camo

## Feature highlights



### Grip It and Rip It

Smart-Lok™ is the most advanced off-road front differential. It's fully lockable on-the-fly, and its four automatic modes return the most grip possible in every condition when you ride the Can-Am Commander MAX Xmr 1000R.



### Take in This Air Intake!

This model has a strategically positioned engine air intake and CVT inlet/outlet for maximum power and swamp-capable performance. It provides the engine with cooler intake air temperatures for better response when you ride.



### Feeling Special and Connected

The seats on the Commander MAX Xmr 1000R are special edition. Designed to place driver and passenger at the center of it all, the seats are comfortable and connect those inside to the vehicle's every move. Plus, they do it all without compromising ground clearance.



### Make Heads Turn as You Ride

Stand out in the best way when you ride in a Commander MAX Xmr 1000R. The model has an LED headlight and a Can-Am LED signature for a more aggressive look.

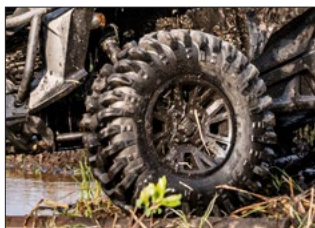

### XPS Tires and Aluminum Wheels

The Can-Am Commander MAX Xmr 1000R sits on 14 in. cast-aluminum wheels with 30 in. XPS Swamp Force tires. The high-performance Swamp Force is designed to attack and overcome the muddiest of riding conditions.



### More Bumps? No Problem!

At the front of this side-by-side sits a heavy-duty front steel bumper. Protecting the front of your vehicle, this bumper clears the way with an enhanced protection from the obstacles you drive across.



### Made for the muddier ride

The Can-Am Commander MAX Xmr 1000R comes equipped with a 4,500-lb (2,041 kg) winch. You can engage it with only the flick of a switch to dominate the most challenging terrain. This feature is effective for vehicle recovery, clearing brush, and pushing further on every mud adventure.



### Can Things Get Too Muddy?

This do-it-all side-by-side comes equipped with mudguards extension to help riders dive into the gnarliest holes they come across. The extension over the curved strip of the wheel of the unit is designed to protect both rider and vehicle from water and dirt that jumps in the air as you enjoy epic mud adventures.

# 2024 COMMANDER XT 700

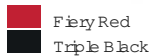

| ENGINES              |  | 700 |
|----------------------|--|-----|
| Type                 | 52 hp / 42 b-hp, Rotax® ACE (Advanced Combustion Efficiency) 650 cc single cylinder, liquid-cooled |     |
| Fuel Delivery System | Intelligent Throttle Control (ITC™) with Electronic Fuel Injection (EFI)                           |     |
| Transmission         | 5 Drive primary CVT with engine braking and Electronic Drive Belt Protection L / H / N / R / P     |     |
| Drive Train          | Selectable Turf Mode / 2WD / 4WD with Visco-Lok® QE auto-locking front differential                |     |
| Driving Assistance   | Electronic Hill Descent Control SPORT / ECO™ modes   |     |
| Power Steering       | Dynamic Power Steering (DPS™)  |     |
| SUSPENSIONS          |  |     |
| Front Suspension     | Double A-arm with sway bar / 12.5 in. (31.8 cm) suspension travel                                  |     |
| Front Shocks         | Tw in tube gas-charged shocks  |     |
| Rear Suspension      | TTA with sway bar / 13 in. (33 cm) suspension travel   |     |
| Rear Shocks          | Tw in tube gas-charged shocks  |     |
| TIRES & WHEELS       |  |     |
| Front / Rear Tires   | XPS TrailKing 28 x 9 / 11 x 14 in.   |     |
| Wheels               | 14 in. cast aluminum   |     |
| BRAKES               |  |     |
| Front / Rear         | Dual 220 mm disc brakes with hydraulic twin-piston calipers  |     |

## PACKAGE HIGHLIGHTS

- 7.6 in. digital display with keypad
- Can-Am LED signature
- 28 in. XPS TrailKing tires
- 14 in. cast aluminum wheels
- XT front bumper
- 4,500 lb (2,041 kg) winch
- Full roof

## DIMENSIONS & CAPACITIES

|                      |   |
|----------------------|---|
| Estimated Dry Weight | 1,575 lb (714.4 kg)                           |
| Chassis / Cage       | Profiled cage, ROPS approved                  |
| L x W x H            | 130 x 62 x 74 in. (330.2 x 157.5 x 188 cm)    |
| Wheelbase            | 90.6 in. (230.1 cm)                           |
| Ground Clearance     | 13 in. (33 cm)                                |
| Cargo Box Dimensions | 29.5 x 45.2 x 10.6 in. (75.1 x 114.7 x 27 cm) |
| Cargo Box Capacity   | 600 lb (272.2 kg)                             |
| Towing Capacity      | 2,000 lb (907.2 kg)                           |
| Payload Capacity     | 1,030 lb (467.2 kg)                           |
| Storage Capacity     | Total: 7.3 gal (27.6 L)                       |
| Fuel Capacity        | 10 gal (38 L)                                 |

## FEATURES

|                   |  |
|-------------------|--|
| Gauge             | 7.6 in. wide digital display with keypad   |
| Instrumentation   | DC outlet (10 A)   |
| Anti-Theft System | RF Digitally Encoded Security System (DESS™) with Start / Stop button              |
| Magneto           | 650 W  |
| Lighting          | Front lighting output 110 W<br>LED signature<br>LED taillights                     |
| Winch             | 4,500 lb (2,041 kg) winch with roller fairlead                                     |
| Steering Wheel    | Adjustable tilt steering   |
| Protection        | Premium half doors<br>Full skid plate<br>Mudguards<br>XT front bumper<br>Full roof |
| Hitch Type        | 2 in. hitch receiver   |

## WARRANTY & EXTENDED SERVICE

|                        |                                     |
|------------------------|-------------------------------------|
| Factory Warranty       | 6-month BRP limited warranty        |
| Extended Service Terms | BEST term available up to 30 months |

† Visco-Lok is a trademark of GKN Visco Drive GmbH.  
All other trademarks are the property of their respective owners.



 Fiery Red

## Feature highlights



### All Information at Your Fingertips

All you need to enjoy the perfect adventure is on the Can-Am Commander XT 700's 7.6 inch digital screen. It's big enough that our riders can read from the screen in all conditions. Plus, it puts their vehicle's information and controls within arm's reach.



### A Signature Look

Ride with style in the Can-Am Commander XT 700 courtesy of the Can-Am LED Signature Lights and headlight. With these on, you deliver a more aggressive and big look and light up the way with bright and energy-efficient LEDs.



### XPS Tires for Extra Fun on the Trail

The Can-Am Commander XT 700 sits on 28 in. XPS TrailKing with 14 in. cast-aluminum wheels built to perform in any condition and on the roughest terrains. With a non-directional pattern that provides predictable cornering and claws, these tires deliver when you need them. If you plan to haul, tow, or carry heavy loads with your vehicle, you're in good hands driving on these tires.



### More Bumps? No Problem!

At the front of this side-by-side sits a dependable and sturdy XT front bumper. Protecting the front of your vehicle, this bumper clears the way with enhanced protection from the obstacles you drive across.



### Made for the Longer Haul





The Can-Am Commander XT 700 comes equipped with a 4,500-lb (2,041 kg) winch. You can engage it with only the flick of a switch to dominate the most difficult tasks. This feature is effective for vehicle recovery, hunting trips, clearing brush, and every tough challenge at the worksite.



### Not Just a Roof!

Over your head in the Can-Am Commander XT 700 is a full hard roof that gives you better protection from the elements. Keep sunlight, rain or snow away when getting tasks done.



| COMMANDER             |   | DPS***   |   | XT***  |   |
|-----------------------|---|--|---|--|---|
|                       |   |   |    |    |    |
| COLOR OPTIONS         |   | Tundra Green   | Tundra Green  | Fiery Red Triple Black   | Fiery Red Triple Black Withland Camo  |
| ENGINES               | Type  | 700  | 1000R   | 700  | 1000R   |
|                       | Fuel Delivery System  | Intelligent Throttle Control (ITC™) with Electronic Fuel Injection (EFI)   |   | Intelligent Throttle Control (ITC™) with Electronic Fuel Injection (EFI)   |   |
|                       | Transmission  | 52 hp / 42 in. Rotax® ACE (Advanced Combustion Efficiency) 650 cc single cylinder, liquid-cooled<br>pDrive primary CVT with engine braking and Electronic Drive Belt Protection<br>L / H / N / R / P | 100 hp, Rotax® 976 cc, V-twin, liquid-cooled<br>Quick Response System (QRS) CVT with high airflow ventilation and Electronic Drive Belt Protection<br>Extra-L / H / N / R / P | 52 hp / 42 in. Rotax® ACE (Advanced Combustion Efficiency) 650 cc single cylinder, liquid-cooled<br>pDrive primary CVT with engine braking and Electronic Drive Belt Protection<br>L / H / N / R / P | 100 hp, Rotax® 976 cc, V-twin, liquid-cooled<br>Quick Response System (QRS) CVT with high airflow ventilation and Electronic Drive Belt Protection<br>Extra-L / H / N / R / P |
|                       | Drive Train   | Selectable Turf Mode / 2WD / 4WD with Visco-Lok® QE auto-locking front differential  | Selectable Turf Mode / 2WD / 4WD with Visco-Lok® auto-locking front differential  | Selectable Turf Mode / 2WD / 4WD with Visco-Lok® auto-locking front differential   |   |
|                       | Driving Assistance  | Electronic Hill Descent Control SPORT / ECO™ modes   |   | Electronic Hill Descent Control SPORT / ECO™ modes   |   |
|                       | Power Steering  | Dynamic Power Steering (DPS™)  |   | Dynamic Power Steering (DPS™)  |   |
| SUSPENSIONS           | Front Suspension  | Double A-arm with swaybar / 12.5 in. (31.8 cm) suspension travel   |   | Double A-arm with swaybar / 12.5 in. (31.8 cm) suspension travel   | Arched double A-arm with swaybar / 15 in. (38.1 cm) suspension travel   |
|                       | Front Shocks  | Twin tube gas-charged shocks   |   | Twin tube gas-charged shocks   |   |
|                       | Rear Suspension   | TTA with swaybar / 13 in. (33 cm) suspension travel  |   | TTA with swaybar / 13 in. (33 cm) suspension travel  | Arched TTA with swaybar / 15 in. (38.1 cm) suspension travel  |
|                       | Rear Shocks   | Twin tube gas-charged shocks   |   | Twin tube gas-charged shocks   |   |
| TIRES WHEELS          | XPS TrailForce 27 x 9 / 11 x 14 in. 14 in. steel            |  | XPS TrailKing 28 x 9 / 11 x 14 in. 14 in. castaluminum  |  |   |
| BRAKES                | Dual 220 mm disc brakes with hydraulic twin-piston calipers |  | Dual 220 mm disc brakes with hydraulic twin-piston calipers   |  |   |
| DIMENSIONS CAPACITIES | Estimated Dry Weight  | 1,530 lb (694 kg)  | 1,600 lb (725.5 kg)   | 1,575 lb (714.4 kg)  | 1,675 lb (759.8 kg)   |
|                       | Chassis / Cage  | Profiled cage, ROPS approved   |   | Profiled cage, ROPS approved   |   |
|                       | L x W x H   | 128.5 x 62 x 70.5 in. (326.4 x 157.5 x 180.2 cm)   |   | 130 x 62 x 74 in. (330.2 x 157.5 x 188 cm)   | 130 x 64 x 74 in. (330.2 x 162.6 x 188 cm)  |
|                       | Wheelbase   | 90.6 in. (230.1 cm)  |   | 90.6 in. (230.1 cm)  |   |
|                       | Ground Clearance  | 12.5 in. (31.8 cm)   |   | 13 in. (33 cm)   |   |
|                       | Cargo Box Dimension   | 29.5 x 45.2 x 10.6 in. (75.1 x 114.7 x 27 cm)  |   | 29.5 x 45.2 x 10.6 in. (75.1 x 114.7 x 27 cm)  |   |
|                       | Cargo Box Capacity  | 600 lb (272.2 kg)  |   | 600 lb (272.2 kg)  |   |
|                       | Towing Capacity   | 2,000 lb (907.2 kg)  |   | 2,000 lb (907.2 kg)  |   |
|                       | Payload Capacity  | 1,030 lb (467.2 kg)  |   | 1,030 lb (467.2 kg)  |   |
|                       | Storage Capacity  | Total 7.3 gal (27.6 L)   |   | Total 7.3 gal (27.6 L)   |   |
| Fuel Capacity         | 10 gal (38 L)   |  | 10 gal (38 L)   |  |   |
| FEATURES              | Gauge   | 4.5 in. wide digital display   |   | 7.6 in. wide digital display with keypad   |   |
|                       | Instrumentation   | DC outlet (10 A)   |   | DC outlet (10 A)   |   |
|                       | Anti-Theft System   | RF Dignally Encoded Security System (DESS™) with start/stop button   |   | RF Dignally Encoded Security System (DESS™) with start/stop button   |   |
|                       | Magneto   | 650 W  |   | 650 W  |   |
|                       | Lighting  | Front lighting output 110 W<br>LED taillights  |   | Front lighting output 110 W<br>LED Signature<br>LED taillights   |   |
|                       | Winch   | N/A  |   | 4,500 lb (2,041 kg) winch with roller fairlead   |   |
|                       | Steering Wheel  | Adjustable tilt steering   |   | Adjustable tilt steering   |   |
|                       | Protection  | Premium halfdoors<br>Fullskid plate<br>Mudguards   |   | Premium halfdoors<br>Fullskid plate<br>Mudguards<br>XT front bumper<br>Fullroof  |   |
|                       | Hitch Type  | 2 in. hitch receiver   |   | 2 in. hitch receiver   |   |

<sup>1</sup>Visco-Lok is a trademark of GKN Visco Drive GmbH.

<sup>2</sup>Sm anti-Lok was developed in conjunction with TEAM Industries, a market leader in the drive train industry.

<sup>3</sup>\*\*6-month BRP limited warranty. BEST term available up to 30 months.







| COMMANDER               |                              | XT-P***  | Xmr***  | MAX DPS***   |  |
|-------------------------|------------------------------|--|---|--|--|
|                         |                              |   |    |                                    |   |
| COLOR OPTIONS           |                              | Desert Tan & Carbon Black  | Wildland Camo   | Tundra Green   | Tundra Green   |
| ENGINES                 | Type                         | 1000R<br>100 hp, Rotax® 976 cc, V-twin, liquid-cooled  | 1000R<br>100 hp, Rotax® 976 cc, V-twin, liquid-cooled   | 700<br>52 hp / 42 b-ft, Rotax® ACE (Advanced Combustion Efficiency) 650 cc single cylinder, liquid-cooled            | 1000R<br>100 hp, Rotax® 976 cc, V-twin, liquid-cooled  |
|                         | Fuel Delivery System         | Intelligent Throttle Control (ITC™) with Electronic Fuel Injection (EFI)   | Intelligent Throttle Control (ITC™) with Electronic Fuel Injection (EFI)  | Intelligent Throttle Control (ITC™) with Electronic Fuel Injection (EFI)   |  |
|                         | Transmission                 | Quick Response System (QRS) CVT with high airflow ventilation and Electronic Drive Belt Protection Extra-L / H / N / R / P | Quick Response System (QRS) CVT with high airflow ventilation. Strategically positioned CVT air intakes and exhaust. Lower gearing ratio and Electronic Drive Belt Protection Extra-L / H / N / R / P | pro Prime any CVT with engine braking and Electronic Drive Belt Protection L / H / N / R / P                         | Quick Response System (QRS) CVT with high airflow ventilation and Electronic Drive Belt Protection Extra-L / H / N / R / P |
|                         | Drive Train                  | Selectable Turf mode / 2W D / 4W D TRAIL / 4W D TRAIL ACTIV with exclusive Smart-Lok* technology                           | Lockable front differential with exclusive Smart-Lok* technology. True 4 modes traction system: 2W D / 4W D with front diff. lock / 4W D MUD / 4W D TRAIL   | Selectable Turf mode / 2W D / 4W D with Visco-Lok® auto-locking front differential                                   |  |
|                         | Driving Assistance           | Electronic Hill Descent Control SPORT / ECO™ modes   | Electronic Hill Descent Control SPORT / ECO™ modes  | Electronic Hill Descent Control SPORT / ECO™ modes   |  |
|                         | Power Steering               | Dynamic Power Steering (DPS™)  | Dynamic Power Steering (DPS™)   | Dynamic Power Steering (DPS™)  |  |
|                         | SUSPENSIONS                  | Front Suspension   | Arched double A-am with sway bar / 14 in. (35.6 cm) suspension travel   | Arched double A-am with sway bar / 14 in. (35.6 cm) suspension travel  | Double A-am with sway bar / 12.5 in. (31.8 cm) suspension travel   |
| Front Shocks            |                              | FOX® 2.5 PODIUM Piggyback with QS3® compression adjustment   | Twin tube gas-charged shocks  | Twin tube gas-charged shocks   |  |
| Rear Suspension         |                              | Arched TTA with sway bar / 14 in. (35.6 cm) suspension travel  | Arched TTA with sway bar / 14 in. (35.6 cm) suspension travel   | TTA with sway bar / 13 in. (33 cm) suspension travel   |  |
| Rear Shocks             |                              | FOX® 2.5 PODIUM Piggyback with QS3® compression adjustment   | Twin tube gas-charged shocks  | Twin tube gas-charged shocks   |  |
| TIRES & WHEELS          | Front / Rear Tires<br>Wheels | XPS Hammer Force 30 x 10 x 15 in. 15 in. (38.1 cm) cast-aluminum beadlock  | XPS Swamp Force 30 x 9 / 11 x 14 in. 14 in. cast-aluminum   | XPS Trail Force 27 x 9 / 11 x 14 in. 14 in. steel  |  |
| BRAKES                  | Front / Rear                 | Dual 220 mm disc brakes with hydraulic twin-piston calipers  | Dual 220 mm disc brakes with hydraulic twin-piston calipers   | Dual 220 mm disc brakes with hydraulic twin-piston calipers  |  |
| DIMENSIONS & CAPACITIES | Estimated Dry Weight         | 1,725 lb (782.4 kg)  | 1,808 lb (820 kg)   | 1,863 lb (847 kg)  | 1,855 lb (841.4 kg)  |
|                         | Chassis / Cage               | Profiled cage, ROPS approved   |   | Profiled cage, ROPS approved   |  |
|                         | L x W x H                    | 130 x 64 x 74.5 in. (330.2 x 162.6 x 189.6 cm)   |   | 158.3 x 62 x 73 in. (401.8 x 157.5 x 185.4 cm)   |  |
|                         | Wheelbase                    | 90.6 in. (230.1 cm)  |   | 120.6 in. (306.3 cm)   |  |
|                         | Ground Clearance             | 13.5 in. (34.3 cm)   |   | 12.5 in. (31.8 cm)   |  |
|                         | Cargo Box Dimension          | 29.5 x 45.2 x 10.6 in. (75.1 x 114.7 x 27 cm)  |   | 29.5 x 45.2 x 10.6 in. (75.1 x 114.7 x 27 cm)  |  |
|                         | Cargo Box Capacity           | 600 lb (272.2 kg)  |   | 600 lb (272.2 kg)  |  |
|                         | Towing Capacity              | 2,000 lb (907.2 kg)  |   | 2,000 lb (907.2 kg)  |  |
|                         | Payload Capacity             | 1,030 lb (467.2 kg)  |   | 1,280 lb (580.6 kg)  |  |
|                         | Storage Capacity             | Total: 7.3 gal (27.6 L)  |   | Total: 8.5 gal (32.1 L)  |  |
| Fuel Capacity           | 10 gal (38 L)                |  | 10 gal (38 L)   |  |  |
| FEATURES                | Gauge                        | 7.6 in. wide digital display with keypad   |   | 4.5 in. wide digital display   |  |
|                         | Instrumentation              | DC outlet (10 A)   |   | DC outlet (10 A)   |  |
|                         | Anti-Theft System            | RF Digitally Encoded Security System (DESS™) with start/stop button  |   | RF Digitally Encoded Security System (DESS™) with start/stop button  |  |
|                         | Magneto                      | 650 W  |   | 650 W  |  |
|                         | Lighting                     | LED Headlight<br>LED Signature<br>LED taillights   |   | Front lighting output 110 W<br>LED taillights  |  |
|                         | Winch                        | 4,500 lb (2,041 kg) winch with roller fairlead   |   | N/A  |  |
|                         | Steering Wheel               | Adjustable tilt steering   |   | Adjustable tilt steering   |  |
|                         | Protection                   | Premium halfdoors<br>Fullskid plate<br>Mudguards<br>XT front bumper<br>Full roof   |   | Premium halfdoors<br>Fullskid plate<br>Mudguards / mudguards extension<br>Heavy-duty front steel bumper<br>Mudguards |  |
|                         | Hitch Type                   | 2 in. hitch receiver   |   | 2 in. hitch receiver   |  |

\*Visco-Lok is a trademark of GKN Viscodrive GmbH.

\*\*Smart-Lok was developed in conjunction with TEAM Industries, a market leader in the drive train industry.

\*\*\*6-month BRP limited warranty. BEST team available up to 30 months.

| COMMANDER               |  | MAX XT***  |   | MAX XT-P***   | MAX X mr***   |
|-------------------------|--|--|---|---|---|
|                         |  |                       |    |   |    |
| COLOR OPTIONS           |  | Fiery Red<br>Triple Black  | Fiery Red<br>Triple Black<br>Whitland Camo  | Desert Tan & Carbon Black   | Whitland Camo   |
| ENGINES                 | Type   | 700  | 1000R   | 1000R   | 1000R   |
|                         | Fuel Delivery System   | Intelligent Throttle Control (ITC™) w/ Electronic Fuel Injection (EFI)                                 |   | Intelligent Throttle Control (ITC™) w/ Electronic Fuel Injection (EFI)  | Intelligent Throttle Control (ITC™) w/ Electronic Fuel Injection (EFI)  |
|                         | Transmission   | 52 hp / 42 b-ft, Rotax® ACE<br>Advanced Combustion Efficiency<br>650 cc single cylinder, liquid-cooled | 100 hp, Rotax® 976 cc,<br>V-twin, liquid-cooled   | 100 hp, Rotax® 976 cc,<br>V-twin, liquid-cooled   | 100 hp, Rotax® 976 cc,<br>V-twin, liquid-cooled   |
|                         | Drive Train  | pdrive primary CVT w/ engine braking<br>and Electronic Drive Belt Protection<br>L/H/N/R/P              | Quick Response System (QRS) CVT<br>w/ high airflow ventilation and Electronic<br>Drive Belt Protection<br>Extra-L/H/N/R/P | Quick Response System (QRS) CVT<br>w/ high airflow ventilation and Electronic<br>Drive Belt Protection<br>Extra-L/H/N/R/P | Quick Response System (QRS) CVT w/ high<br>airflow ventilation. Strategically positioned CVT<br>air intakes and exhaust. Low gearing ratio and<br>Electronic Drive Belt Protection<br>Extra-L/H/N/R/P |
|                         | Driving Assistance   | Electronic Hill Descent Control<br>SPORT / ECO™ modes  |   | Electronic Hill Descent Control<br>SPORT / ECO™ modes   | Electronic Hill Descent Control<br>SPORT / ECO™ modes   |
|                         | Power Steering   | Dynamic Power Steering (DPS™)  |   | Dynamic Power Steering (DPS™)   | Dynamic Power Steering (DPS™)   |
| SUSPENSIONS             | Front Suspension   | Double A-arm w/ sway bar/<br>12.5 in. (31.8 cm) suspension travel                                      | Arched double A-arm w/ sway bar/<br>15 in. (38.1 cm) suspension travel  | Arched double A-arm w/ sway bar/<br>14 in. (35.6 cm) suspension travel  | Arched double A-arm w/ sway bar/<br>14 in. (35.6 cm) suspension travel  |
|                         | Front Shocks   | Tw in tube gas-charged shocks  |   | FOX® 2.5 POD IJM Piggyback w/ QS3'<br>compression adjustment  | Tw in tube gas-charged shocks   |
|                         | Rear Suspension  | TTA w/ sway bar/<br>13 in. (33 cm) suspension travel   | Arched TTA w/ sway bar/<br>15 in. (38.1 cm) suspension travel   | Arched TTA w/ sway bar/<br>14 in. (35.6 cm) suspension travel   | Arched TTA w/ sway bar/<br>14 in. (35.6 cm) suspension travel   |
|                         | Rear Shocks  | Tw in tube gas-charged shocks  |   | FOX® 2.5 POD IJM Piggyback w/ QS3'<br>compression adjustment  | Tw in tube gas-charged shocks   |
| TIRES<br>WHEELS         | Front / Rear Tires<br>XPS TrailKing 28 x 9 / 11 x 14 in.<br>14 in. cast-alum rim |  | XPS HammerForce 30 x 10 x 15 in.<br>15 in. cast-alum rim beadlock   | XPS Swamp Force 30 x 9 / 11 x 14 in.<br>14 in. cast-alum rim  |   |
| BRAKES                  | Front / Rear<br>Dual 220 mm disc brakes w/ hydraulic twin-piston calipers        |  | Dual 220 mm disc brakes w/ hydraulic<br>twin-piston calipers  | Dual 220 mm disc brakes w/ hydraulic<br>twin-piston calipers  |   |
| DIMENSIONS / CAPACITIES | Estimated Dry Weight   | 1,874 lb (852 kg)  | 1,930 lb (875.4 kg)   | 2,000 lb (907.2 kg)   | 2,061 lb (937 kg)   |
|                         | Chassis / Cage   | Profiled cage, ROPS approved   |   | Profiled cage, ROPS approved  | Profiled cage, ROPS approved  |
|                         | L x W x H  | 160.4 x 64 x 76.2 in. (407.4 x 162.6 x 193.5 cm)   |   | 160.4 x 64 x 76.7 in. (407.4 x 162.6 x 194.8 cm)  | 152 x 64 x 74.25 in. (386.1 x 162.6 x 188.6 cm)   |
|                         | Wheelbase  | 120.6 in. (306.3 cm)   |   | 120.6 in. (306.3 cm)  | 120.6 in. (306.3 cm)  |
|                         | Ground Clearance   | 13 in. (33 cm)   |   | 13.5 in. (34.3 cm)  | 13.5 in. (34.3 cm)  |
|                         | Cargo Box Dimension  | 29.5 x 45.2 x 10.6 in. (75.1 x 114.7 x 27 cm)  |   | 29.5 x 45.2 x 10.6 in. (75.1 x 114.7 x 27 cm)   | 29.5 x 45.2 x 10.6 in. (75.1 x 114.7 x 27 cm)   |
|                         | Cargo Box Capacity   | 600 lb (272.2 kg)  |   | 600 lb (272.2 kg)   | 600 lb (272.2 kg)   |
|                         | Towing Capacity  | 2,000 lb (907.2 kg)  |   | 2,000 lb (907.2 kg)   | 2,000 lb (907.2 kg)   |
|                         | Payload Capacity   | 1,280 lb (580.6 kg)  |   | 1,280 lb (580.6 kg)   | 1,280 lb (580.6 kg)   |
|                         | Storage Capacity   | Total: 8.5 gal (32.1 L)  |   | Total: 8.5 gal (32.1 L)   | Total: 8.5 gal (32.1 L)   |
| Fuel Capacity           | 10 gal (38 L)  |  | 10 gal (38 L)   | 10 gal (38 L)   |   |
| FEATURES                | Gauge  | 7.6 in. w/ tie digital display w/ keypad   |   | 7.6 in. w/ tie digital display w/ keypad  | 7.6 in. w/ tie digital display w/ keypad  |
|                         | Instrumentation  | DC outlet (10 A)   |   | DC outlet (10 A)  | DC outlet (10 A)  |
|                         | Anti-Theft System  | RF D igitally Encoded Security System (DESS™) w/ start/stop button                                     |   | RF D igitally Encoded Security System<br>(DESS™) w/ start/stop button   | RF D igitally Encoded Security System<br>(DESS™) w/ start/stop button   |
|                         | Magneto  | 650 W  |   | 650 W   | 650 W   |
|                         | Lighting   | Front lighting output 110 W<br>LED Signature<br>LED taillights   |   | LED Headlight<br>LED Signature<br>LED taillights  | LED Headlight<br>LED Signature<br>LED taillights  |
|                         | Winch  | 4,500 lb (2,041 kg) w/ inch w/ roller fairlead   |   | 4,500 lb (2,041 kg) w/ inch w/ roller fairlead  | Recoated 4,500 lb (2,041 kg) w/ inch w/ synthetic rope<br>and roller fairlead   |
|                         | Steering Wheel   | Adjustable tilt steering   |   | Adjustable tilt steering  | Adjustable tilt steering  |
|                         | Protection   | Premium half doors<br>Full ski plate<br>Mudguards<br>XT frontbumper per<br>Full roof                   |   | Premium half doors<br>Full ski plate<br>Mudguards<br>XT frontbumper per<br>Full roof                                      | Premium half doors<br>Full ski plate<br>Mudguards / mudguards extension<br>Heavy-duty front steel bumper per  |
|                         | Hitch Type   | 2 in. hitch receiver   |   | 2 in. hitch receiver  | 2 in. hitch receiver  |

\*Visco-Lok is a trademark of GKN Viscotrade GmbH.

\*\*Sm anti-Lok was developed in conjunction with TEAM Industries, a market leader in the drive train industry.

\*\*\*6-month BRP limited warranty. BEST term available up to 30 months.







# 2024 MAVERICK TRAIL



Catalyst Gray

| <b>ENGINE</b>             |   |
|---------------------------|---|
| Type                      | 52 hp / 42 lb-ft, Rotax <sup>®</sup> ACE (Advanced Combustion Efficiency) 650 cc single cylinder, liquid-cooled |
| Fuel Delivery System      | Intelligent Throttle Control (ITC™) with Electronic Fuel Injection (EFI)  |
| Transmission              | pDrive primary CVT with engine braking and Electronic Drive Belt Protection L / H / N / R / P                   |
| Drive Train               | Selectable 2WD / 4WD with Visco-Lok <sup>†</sup> auto-locking front differential                                |
| Driving Assistance        | Electronic Hill Descent Control SPORT / ECO™ modes  |
| Power Steering            | N/A   |
| <b>SUSPENSIONS</b>        |   |
| Front Suspension          | Double A-arm with sway bar / 10 in. (25.4 cm) suspension travel   |
| Front Shocks              | Twin tube gas-charged shocks  |
| Rear Suspension           | TTA with sway bar / 10.5 in. (26.7 cm) suspension travel  |
| Rear Shocks               | Twin tube gas-charged shocks  |
| <b>TIRES &amp; WHEELS</b> |   |
| Front / Rear Tires        | Carlisle ACT 26 x 8 / 9 x 12 in.  |
| Wheels                    | 12 in. steel  |
| <b>BRAKES</b>             |   |
| Front / Rear              | Dual 220 mm disc brakes with hydraulic twin-piston calipers   |

| <b>DIMENSIONS &amp; CAPACITIES</b>     |  |
|--|--|
| Estimated Dry Weight                   | 1,256 lb (569.7 kg)                              |
| Chassis / Cage                         | Profiled cage, ROPS approved                     |
| L x W x H                              | 118 x 50 x 69 in. (300.5 x 127 x 175.3 cm)       |
| Wheelbase                              | 90.6 in. (230.1 cm)                              |
| Ground Clearance                       | 10 in. (25.4 cm)                                 |
| Cargo Box Capacity                     | 300 lb (136 kg)                                  |
| Towing Capacity                        | 1,500 lb (680 kg)                                |
| Storage Capacity                       | Total: 5.3 gal (20.2 L)                          |
| Fuel Capacity                          | 10 gal (38 L)                                    |
| <b>FEATURES</b>                        |  |
| Gauge                                  | 4.5 in. wide digital display                     |
| Instrumentation                        | DC outlet (10 A)                                 |
| Magneto                                | 650 W  |
| Lighting                               | Front lighting output 110 W<br>LED tail lights   |
| Winch                                  | N/A  |
| Steering Wheel                         | Adjustable tilt steering                         |
| Protection                             | Integrated front steel bumper<br>Full skid plate |
| Hitch Type                             | 2 in. hitch receiver                             |
| <b>WARRANTY &amp; EXTENDED SERVICE</b> |  |
| Factory Warranty                       | 6-month BRP limited warranty                     |
| Extended Service Terms                 | B.E.S.T. term available up to 30 months          |

<sup>†</sup> Visco-Lok is a trademark of GKN Viscodrive GmbH.  
All other trademarks are the property of their respective owners.





Catalyst Gray

## Feature highlights



### Powerful Rotax Engine

Rotax® ACE 650-cc single cylinder engine is built to exceed expectations. With 52 horsepower and 41 lb-ft behind it, this engine delivers responsive power and torque from the moment riders put their hands on the wheel.

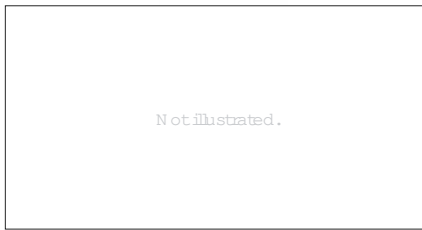



### CVT Delivers in the Clutch!

The primary CVT is the primary reason why a Maverick Trail 700 is so much fun! This feature comes with engine braking and protects the electronic drive belt of your high-performing sidekick. Take it all in and it delivers instant performance, more traction and more reliability – but that's not all! The primary CVT is less noisy, less harsh and requires less maintenance.



### Differential That Makes a Difference



The Can-Am Maverick Trail 700 has a Visco-Lok® auto-locking front differential that delivers grip and traction for days wherever you're riding. This feature turns the front differential on your vehicle into a sort of pump: the front wheels' spinning locks the feature in place. Engage wheel drive lock mode for better traction and keep rolling on for epic adventures.

|                         |                              | MAVERICK TRAIL***  | MAVERICK TRAIL DPS***  |   |
|-------------------------|------------------------------|--|--|---|
|                         |                              |                       |                       |    |
| COLOR OPTIONS           |                              | Catalyst Gray  | Triple Black   | Flare Red   |
| ENGINES                 | Type                         | 700<br>52 hp / 42 in. Rotax® ACE Advanced Combustion Efficiency) 650 cc single cylinder, liquid-cooled | 700<br>52 hp / 42 in. Rotax® ACE Advanced Combustion Efficiency) 650 cc single cylinder, liquid-cooled | 1000<br>75 hp, Rotax® 976 cc, V-twin, liquid-cooled   |
|                         | Fuel Delivery System         | Intelligent Throttle Control (ITC™) with Electronic Fuel Injection (EFI)                               |  |   |
|                         | Transmission                 | 5-speed primary CVT with engine braking and Electronic Drive Belt Protection<br>L / H / N / R / P      | 5-speed primary CVT with engine braking and Electronic Drive Belt Protection<br>L / H / N / R / P      | Quick Response System (QRS) CVT with high airflow ventilation and Electronic Drive Belt Protection<br>Extra-L / H / N / R / P |
|                         | Drive Train                  | Selectable 2WD / 4WD with Visco-Lok® auto-locking front differential                                   | Selectable 2WD / 4WD with Visco-Lok® Q.E auto-locking front differential                               |   |
|                         | Driving Assistance           | Electronic Hill Descent Control<br>SPORT / ECO™ modes  | Electronic Hill Descent Control<br>SPORT / ECO™ modes  |   |
|                         | Power Steering               | N/A  | Dynamic Power Steering (DPS™)  |   |
|                         | SUSPENSIONS                  | Front Suspension   | Double A-arm with swaybar / 10 in. (25.4 cm) suspension travel   | Double A-arm with swaybar / 10 in. (25.4 cm) suspension travel  |
| Front Shocks            |                              | Twin tube gas-charged shocks   | Twin tube gas-charged shocks   |   |
| Rear Suspension         |                              | TTA with swaybar / 10.5 in. (26.7 cm) suspension travel  | TTA with swaybar / 10.5 in. (26.7 cm) suspension travel  |   |
| Rear Shocks             |                              | Twin tube gas-charged shocks   | Twin tube gas-charged shocks   |   |
| TIRES & WHEELS          | Front / Rear Tires<br>Wheels | Carlisle ACT 26 x 8 / 9 x 12 in. 12 in. steel  | Carlisle ACT 26 x 8 / 9 x 12 in. 12 in. cast aluminum  |   |
| BRAKES                  | Front / Rear                 | Dual 220 mm disc brakes with hydraulic twin-piston calipers  |  |   |
| DIMENSIONS & CAPACITIES | Estimated Dry Weight         | 1,256 lb (569.7 kg)  | 1,271 lb (576.5 kg)  | 1,364 lb (618.7 kg)   |
|                         | Chassis / Cage               | Profiled cage, ROPS approved   |  |   |
|                         | L x W x H                    | 118 x 50 x 69 in. (300.5 x 127 x 175.3 cm)   |  |   |
|                         | Wheelbase                    | 90.6 in. (230.1 cm)  |  |   |
|                         | Ground Clearance             | 10 in. (25.4 cm)   |  |   |
|                         | Cargo Box Capacity           | 300 lb (136 kg)  |  |   |
|                         | Towing Capacity              | 1,500 lb (680 kg)  |  |   |
|                         | Storage Capacity             | Total 5.3 gal (20.2 L)   |  |   |
|                         | Fuel Capacity                | 10 gal (38 L)  |  |   |
| FEATURES                | Gauge                        | 4.5 in. wide digital display   |  |   |
|                         | Instrumentation              | DC outlet (10 A)   |  |   |
|                         | Magneto                      | 650 W  |  |   |
|                         | Lighting                     | Front lighting output 110 W<br>LED taillights  |  |   |
|                         | Winch                        | N/A  |  |   |
|                         | Steering Wheel               | Adjustable tilt steering   |  |   |
|                         | Protection                   | Integrated front steel bumper per Fullskii plate   | Integrated front steel bumper per Fullskii plate   | Integrated front steel bumper per Halfdoors Fullskii plate  |
|                         | Hitch Type                   | 2 in. hitch receiver   |  |   |

Visco-Lok is a trademark of GKN Viscotek Drive GmbH.

Sm anti-Lok was developed in conjunction with TEAM Industries, a market leader in the drive train industry.

\*\*\*6-month BRP limited warranty, BEST term available up to 30 months.

|                       | MAVERICK SPORT DPS***   | MAVERICK SPORT X rc***  | MAVERICK SPORT X mr***  | MAVERICK SPORT MAX DPS***  |   |
|-----------------------|---|---|---|--|---|
|                       |  |    |   |   |   |
| COLOR OPTIONS         | Flare Red<br>Triple Black   | Hybrid White & Legion Red   | HyperSilver & Legion Red  | Triple Black   |   |
| ENGINES               | Type  | 1000R   | 1000R   | 1000R  |   |
|                       | Fuel Delivery System  | 100 hp, Rotax® 976 cc, V-twin, liquid-cooled  | 100 hp, Rotax® 976 cc, V-twin, liquid-cooled  | 100 hp, Rotax® 976 cc, V-twin, liquid-cooled with strategically positioned engine air intake   | 100 hp, Rotax® 976 cc, V-twin, liquid-cooled  |
|                       | Transmission  | Intelligent Throttle Control (ITC™) with Electronic Fuel Injection (EFI)  | Intelligent Throttle Control (ITC™) with Electronic Fuel Injection (EFI)  | Intelligent Throttle Control (ITC™) with Electronic Fuel Injection (EFI)   | Intelligent Throttle Control (ITC™) with Electronic Fuel Injection (EFI)  |
|                       | Drive Train   | Quick Response System (QRS) CVT with high airflow ventilation and Electronic Drive Belt Protection<br>Extra-L / H / N / R / P | Quick Response System (QRS) CVT with high airflow ventilation and Electronic Drive Belt Protection<br>Extra-L / H / N / R / P   | Quick Response System (QRS) CVT with high airflow ventilation. Strategically positioned CVT air intakes and exhaust. Low gearing ratio and Electronic Drive Belt Protection<br>Extra-L / H / N / R / P | Quick Response System (QRS) CVT with high airflow ventilation and Electronic Drive Belt Protection<br>Extra-L / H / N / R / P |
|                       | Drive Train   | Selectable 2WD / 4WD with Visco-Lok® QE auto-locking front differential   | Lockable front differential with exclusive Smart-Lok® technology. True 4 modes traction system : 2WD / 4WD with front diff lock / 4WD ROCK / 4WD TRAIL  | Lockable front differential with exclusive Smart-Lok® technology. True 4 modes traction system : 2WD / 4WD with front diff lock / 4WD MUD / 4WD TRAIL  | Selectable 2WD / 4WD with Visco-Lok® QE auto-locking front differential   |
|                       | Driving Assistance  | Electronic Hill Descent Control SPORT / ECO™ modes  | Electronic Hill Descent Control SPORT / ECO™ modes  | Electronic Hill Descent Control SPORT / ECO™ modes   | Electronic Hill Descent Control SPORT / ECO™ modes  |
|                       | Power Steering  | Dynamic Power Steering (DPS™)   | Dynamic Power Steering (DPS™)   | Dynamic Power Steering (DPS™)  | Dynamic Power Steering (DPS™)   |
| SUSPENSIONS           | Front Suspension  | Double A-arm with sway bar / 11.5 in. (29.2 cm) suspension travel   | Arched double A-arm with sway bar / 14.8 in. (37.6 cm) suspension travel  | Arched double A-arm with sway bar / 14.8 in. (37.6 cm) suspension travel   | Double A-arm with sway bar / 11.5 in. (29.2 cm) suspension travel   |
|                       | Front Shocks  | SHOW A 2.0  | FOX® 2.5 PODIUM Piggyback with QS3® compression adjustment  | FOX® 2.5 PODIUM Piggyback with QS3® compression adjustment   | SHOW A 2.0  |
|                       | Rear Suspension   | TTA with sway bar / 12 in. (30.5 cm) suspension travel  | Arched TTA with sway bar / 14.8 in. (37.6 cm) suspension travel   | Arched TTA with sway bar / 14.8 in. (37.6 cm) suspension travel  | TTA with sway bar / 12 in. (30.5 cm) suspension travel  |
|                       | Rear Shocks   | SHOW A 2.0  | FOX® 2.5 PODIUM Piggyback with QS3® compression adjustment  | FOX® 2.5 PODIUM Piggyback with QS3® compression adjustment   | SHOW A 2.0  |
| TIRES / WHEELS        | Front / Rear Tires  | M axxis Bighorn 2.0 27 x 9 / 11 x 12 in. 12 in. cast aluminum   | M axxis Liberty® 30 x 10 x 14 in. 14 in. cast aluminum  | XPS Swamp Force 30 x 9 / 11 x 14 in. 14 in. cast aluminum  | M axxis Bighorn 2.0 27 x 9 / 11 x 12 in. 12 in. cast aluminum   |
|                       | Wheels  | 12 in. cast aluminum  | 14 in. cast aluminum  | 14 in. cast aluminum   | 12 in. cast aluminum  |
| BRAKES                | Front / Rear  | Dual 220 mm disc brakes with hydraulic twin-piston calipers   | Dual 220 mm disc brakes with hydraulic twin-piston calipers   | Dual 220 mm disc brakes with hydraulic twin-piston calipers  | Dual 220 mm disc brakes with hydraulic twin-piston calipers   |
| DIMENSIONS CAPACITIES | Estimated Dry Weight  | 1,405 lb (637.3 kg)   | 1,593 lb (722.6 kg)   | 1,617 lb (733.5 kg)  | 1,697 lb (769.7 kg)   |
|                       | Chassis / Cage  | Profiled cage, ROPS approved  | Profiled cage, ROPS approved  | Profiled cage, ROPS approved   | Profiled cage, ROPS approved  |
|                       | L x W x H   | 119 x 60 x 71.1 in. (3022 x 1524 x 180.6 cm)  | 122 x 64 x 74.25 in. (3098 x 162.6 x 188.6 cm)  | 122 x 64 x 74.25 in. (3098 x 162.6 x 188.6 cm)   | 149 x 60 x 76.2 in. (3784 x 1524 x 193.5 cm)  |
|                       | Wheelbase   | 90.6 in. (230.1 cm)   | 90.6 in. (230.1 cm)   | 90.6 in. (230.1 cm)  | 120.6 in. (306.3 cm)  |
|                       | Ground Clearance  | 12 in. (30.5 cm)  | 15 in. (38.1 cm)  | 15 in. (38.1 cm)   | 12 in. (30.5 cm)  |
|                       | Cargo Box Capacity  | 300 lb (136 kg)   | 300 lb (136 kg)   | 300 lb (136 kg)  | 300 lb (136 kg)   |
|                       | Towing Capacity   | 1,500 lb (680 kg)   | 1,500 lb (680 kg)   | 1,500 lb (680 kg)  | 1,500 lb (680 kg)   |
|                       | Storage Capacity  | Total: 5.3 gal (20.2 L)   | Total: 5.3 gal (20.2 L)   | Total: 5.3 gal (20.2 L)  | Total: 6.5 gal (24.7 L)   |
|                       | Fuel Capacity   | 10 gal (38 L)   | 10 gal (38 L)   | 10 gal (38 L)  | 10 gal (38 L)   |
|                       | FEATURES  | Gauge   | 4.5 in. wide digital display  | 7.6 in. wide digital display with keypad   | 7.6 in. wide digital display with keypad  |
| Instrumentation       |   | DC outlet (10 A)  | DC outlet (10 A)  | DC outlet (10 A)   | DC outlet (10 A)  |
| Magneto               |   | 650 W   | 650 W   | 650 W  | 650 W   |
| Lighting              |   | Front lighting output 110 W LED taillights  | Front lighting output 110 W LED Signature LED taillights  | Front lighting output 110 W LED Signature LED taillights   | Front lighting output 110 W LED taillights  |
| Winch                 |   | N/A   | 4,500 lb (2,041 kg) winch with synthetic rope   | 4,500 lb (2,041 kg) winch with synthetic rope  | N/A   |
| Steering Wheel        |   | Adjustable tilt steering  | Adjustable tilt steering  | Adjustable tilt steering   | Adjustable tilt steering  |
| Protection            |   | Integrated front steelbumper per Premium halfdoors<br>Fullskid plate<br>Mudguards   | Integrated front steelbumper per Rear sportbumper per Premium halfdoors<br>Mudguards<br>Front tow hook<br>Fullskid plate<br>UHMWPE rock sliders<br>HMWPE skid plates<br>Differential, front skid plate, front and rear suspension arm<br>Panoramic mirror | Integrated front steelbumper per Premium halfdoors<br>Fullskid plate<br>Mudguards<br>Fender flare extensions<br>Front tow hook   | Integrated front steelbumper per Premium halfdoors<br>Fullskid plate<br>Mudguards   |
| Hitch Type            |   | 2 in. hitch receiver  | 2 in. hitch receiver  | 2 in. hitch receiver   | 2 in. hitch receiver  |

†Visco-Lok is a trademark of GKN Visco Drive GmbH.

\*Smart-Lok was developed in conjunction with TEAM Industries, a market leader in the drive train industry.

\*\*\*6-month BRP limited warranty. BEST team available up to 30 months.









---

# COMMANDER, MAVERICK TRAIL & MAVERICK SPORT ACCESSORIES

---



# BUNDLE UP TO DO IT ALL YOUR COMMANDER BUNDLES

## STEP 1: CHOOSE YOUR ESSENTIAL BUNDLE

|          |                                     | Commander | Commander MAX |
|----------|-------------------------------------|-----------|---------------|
| STARTER  | Full Windshield Hardcoated          | 715003656 | 715003656     |
|          | Sport Roof                          | 715007271 | 715007272     |
|          | Rear Polycarbonate Window           | 715006113 | 715006113     |
|          | Side Mirror                         | 715003639 | 715003639     |
| ADVANCED | LinQ Cargo Rack                     | 715006815 | 715006815     |
|          | Integrated Tailgate Extension       | 715008190 | 715008190     |
|          | LinQ ToolKit                        | 715006829 | 715006829     |
|          | Shoulder Storage Bag                | 715005019 | 715005019     |
|          | Electronic Device Holder            | 715005212 | 715005212     |
| PEAK     | LinQ Tool Holder                    | 715007358 | 715007358     |
|          | Rear View Mirror and Camera Monitor | 715009410 | 715009410     |
|          | LinQ ModularBox (10L)               | 715005494 | 715005494     |

## STEP 2: PICK YOUR ADD-ON BUNDLE

|        |   | Commander | Commander MAX |
|--------|---|-----------|---------------|
| AUDIO  | Complete Wet Sounds Audio System        | 715003672 | 715003672     |
|        | Can-Am Subwoofer                        | 715006359 | 715006359     |
| HUNT   | LinQ Gun Case                           | 715004968 | 715004968     |
|        | 3.5" (Ø cm) LED Flood Lights (2 x 14 W) | 715003665 | 715003665     |
|        | LinQ ModularBox (20 L)                  | 715007112 | 715007112     |
|        | LinQ Base Installation Kit              | 715008125 | 715008125     |
| WORK   | Headache Rack                           | 715006823 | 715006823     |
|        | LinQ Tool & Gun Holder                  | 715005466 | 715005466     |
|        | LinQ Adapter                            | 715003058 | 715003058     |
| WINTER | Upper Soft Door Panels - Front          | 715004718 | 715004718     |
|        | Upper Soft Door Panels - Rear           | -         | 715004726     |
|        | Defrost, Heat and Ventilation System    | 715003678 | 715003678     |
|        | Seat Heater                             | 715006112 | 715006112     |
|        | Heated Accessories Wiring Harness       | 710005757 | 710005757     |

# BUNDLE UP TO RULE THE OFF-ROAD YOUR MAVERICK BUNDLES

## STEP 1: CHOOSE YOUR ESSENTIAL BUNDLE

|          |                                     | Maverick Trail | Maverick Sport | Maverick Sport MAX |
|----------|-------------------------------------|----------------|----------------|--------------------|
| STARTER  | Full Windshield Hardcoated          | 715003656      | 715003656      | 715003656          |
|          | Sport Roof                          | 715007271      | 715007271      | 715007272          |
|          | Rear Polycarbonate Window           | 715006113      | 715006113      | 715006113          |
|          | Side Mirrors                        | 715003639      | 715003639      | 715003639          |
|          | Front TrailBumper                   | 715003680      | 715003680      | 715003680          |
| ADVANCED | Front Corner Protectors             | 715004912      | 715004912      | 715004912          |
|          | Fender Flare Extensions             | 715004462      | 715004462      | 715004462          |
|          | Shoulder Storage Bag                | 715005019      | 715005019      | 715005019          |
|          | Electronic Device Holder            | 715005212      | 715005212      | 715005212          |
| PEAK     | LinQ Pivoting Rack                  | 715008297      | 715008297      | 715008297          |
|          | Rear View Mirror and Camera Monitor | 715009410      | 715009410      | 715009410          |
|          | LinQ 12 Gal (45 L) Cargo Box        | 715003879      | 715003879      | 715003879          |

## STEP 2: PICK YOUR ADD-ON BUNDLE

|       |  | Maverick Trail | Maverick Sport | Maverick Sport MAX |
|-------|--|----------------|----------------|--------------------|
| AUDIO | Complete Wet Sounds Audio System         | 715003672      | 715003672      | 715003672          |
|       | Can-Am Subwoofer                         | 715006359      | 715006359      | 715006359          |
| LIGHT | 15" Double Stacked LED Light Bar (90 W ) | 715002934      | 715002934      | 715002934          |
|       | Light Power Cable                        | 715003670      | 715003670      | 715003670          |
|       | Overhead Switch Panel                    | 715003669      | 715003669      | 715003669          |
|       | LED Headlights Assembly                  | 715003667      | 715003667      | 715003667          |
| RIDER | 4-Point Harness                          | 715008035      | 715008035      | 715008035          |
|       | 4-Point Harness                          | 715008036      | 715008036      | 715008036          |
|       | Seat Shoulder Storage Pads               | 715002894      | 715002894      | 715002894          |
|       | Can-Am HD 4500-S Window                  | 715006417      | 715006417      | 715006417          |
| CABIN | Overhead Storage Bags                    | 715005018      | 715005018      | 715005018          |
|       | Door Knee Pads with Storage              | 715003635      | 715004914      | 715004914          |
|       | LinQ Passenger Seat Base Kit             | 715003951      | 715003951      | 715003951          |
|       | Removable Central Storage Bag            | N/A            | N/A            | 715004794          |



|                   |   |                  |                 |
|-------------------|---|------------------|-----------------|
| <b>Sport Roof</b> | Com m ander, M averick Trail, M averick Sport | <b>715007271</b> | <b>\$399.99</b> |
|                   | Com m ander M AX, M averick Sport M AX        | <b>715007272</b> | <b>\$669.99</b> |



- Excellent protection from the elements.
- Allows installation of lights on top of the roof.
- Compatible with all windshields.

|                                |   |                  |                 |
|--------------------------------|---|------------------|-----------------|
| <b>ProVent Roof Module Kit</b> | Com m ander, M averick Trail, M averick Sport | <b>715005279</b> | <b>\$234.99</b> |
|--------------------------------|---|------------------|-----------------|



- Provides fresh air in the cab area.
- Optimal performance with full cab enclosure.
- 4 vents provide infinite adjustment of airflow for driver and passenger.
- Filter and pre-filter to limit dust intrusion.
- Easy cleaning of filter and pre-filter.
- Patent pending water management system to keep water out of cabin while maintaining airflow.
- Outer plug closes air intake completely for interior heavy weather.
- Requires ProVent Roof Module Adapter Kit for Sport Roof.
- Not compatible with roof mounted LED bars, roof racks, roof liners, Bimini Roof, Dragon Fire Roof and Lonestar Racing Roof.

|   |   |                  |                |
|---|---|------------------|----------------|
| <b>ProVent Roof Module Adapter Kit for Sport Roof</b><br><i>(Not illustrated)</i> | Com m ander, M averick Trail, M averick Sport | <b>715005213</b> | <b>\$92.99</b> |
|---|---|------------------|----------------|

- Adapter for fitting ProVent Roof Module Kit onto Com m ander, M averick Sport or M averick Trail Sport Roof.
- Includes roof adapter and hardware.
- Requires ProVent Roof Module Kit (715005279).

|   |   |                  |                 |
|---|---|------------------|-----------------|
| <b>Bimini<sup>®</sup> Roof with Sun Visor</b> | Com m ander, M averick Trail, M averick Sport | <b>715003661</b> | <b>\$359.99</b> |
|   | Com m ander M AX, M averick Sport M AX        | <b>715004792</b> | <b>\$439.99</b> |



- Heavy-duty canvas made of UV-resistant solution-dyed polyester.
  - Soft top comes with a hard visor that allows for storage of rolled-up soft top and mounting auxiliary lights.
- \*Not compatible with Glass Windshield with wiper.*

|  |   |                            |                 |
|--|---|----------------------------|-----------------|
| <b>Lonestar Racing<sup>®</sup> Aluminum Roof</b> | Com m ander, M averick Trail, M averick Sport | ■ <b>715005137</b> - Black | <b>\$599.99</b> |
|--|---|----------------------------|-----------------|



- Race-truck low profile look with integrated front visor for eye-popping performance and protection.
- 0.083" (2.1 mm) thick aluminum roof for durable and lightweight protection from the elements.
- Not compatible with Full Windshields, Rigid Rear Window, Can-Am<sup>®</sup> Intrusion Bars and Overhead Switch Panel.

# SOFT CAB ENCLOSURE



|                           |                 |                  |                   |
|---------------------------|-----------------|------------------|-------------------|
| <b>Soft Cab Enclosure</b> | M averick Trail | <b>715003618</b> | <b>\$2,119.99</b> |
|---------------------------|-----------------|------------------|-------------------|



- Includes:
- Sport Roof
  - Full Windshield - Hardcoated
  - Upper Soft Door Panels
  - Soft Rear Panel
  - Door Seal Kit
  - Requires Half Doors on 800 Base and 800 DPS models
  - Not compatible with Sport Half Doors



|                           |   |                  |                   |
|---------------------------|---|------------------|-------------------|
| <b>Soft Cab Enclosure</b> | Com m ander,M averick Trail,M averick Sport (exceptX m rm odel) | <b>715004724</b> | <b>\$2,119.99</b> |
|---------------------------|---|------------------|-------------------|



- Can be installed on the M averick Trail,equipped w ith the SportH alf Doors oron M averick Sportm odel.
- Includes:
  - SportRoof
  - FullW indshield - Hardcoated
  - UpperSoftDoorPanels
  - SoftRearPanel

|                           |   |                  |                   |
|---------------------------|---|------------------|-------------------|
| <b>Soft Cab Enclosure</b> | Com m anderM AX,M averick SportM AX (exceptX m rm odel) | <b>715004725</b> | <b>\$3,219.95</b> |
|---------------------------|---|------------------|-------------------|



- Includes:
  - SportRoof
  - FullW indshield - Hardcoated
  - UpperSoftDoorPanels
  - SoftRearPanel

# WINDSHIELDS & WIND PROTECTION



## Windshields

|                         |   |                  |                   |
|-------------------------|---|------------------|-------------------|
| <b>Glass Windshield</b> | Com m ander,Com m anderM AX, M averick Trail,M averick Sport, M averick SportM AX | <b>715003653</b> | <b>\$1,209.99</b> |
|-------------------------|---|------------------|-------------------|



- Curved and laminated glass full windshield in metal frame.
- Provides excellent optical clarity.
- Seals firmly against the cage and protects rider and passenger from the elements.
- Must be used with rear wind protection.
- Not EC compliant.

|                                    |   |                  |                   |
|------------------------------------|---|------------------|-------------------|
| <b>Glass Windshield with Wiper</b> | Com m ander,Com m anderM AX, M averick Trail,M averick Sport, M averick SportM AX | <b>715003652</b> | <b>\$1,769.99</b> |
|------------------------------------|---|------------------|-------------------|



- Curved and laminated glass full windshield in metal frame.
- Provides excellent optical clarity.
- Seals firmly against the cage and protects rider and passenger from the elements.
- Single-speed wiper with washer fluid dispenser.
- Requires the Overhead Switch Panel (715003669) for installation.
- Must be used with rear wind protection.
- Not EC compliant.

|                        |   |  |                                    |
|------------------------|---|--|------------------------------------|
| <b>Half Windshield</b> | Com m ander,Com m anderM AX, M averick Trail,M averick Sport, M averick SportM AX | <input type="checkbox"/> <b>715003657</b> · Clear<br><input checked="" type="checkbox"/> <b>715005280</b> · Tinted | <b>\$349.99</b><br><b>\$359.99</b> |
|------------------------|---|--|------------------------------------|



- Formed polycarbonate construction for enhanced rigidity.
- Formulated to be non-yellowing, non-crazing, non-cracking with excellent UV resistance and optical clarity.
- Protects driver and passenger from the elements.
- Features reverse angle lip to deflect air flow.
- Quick and easy toolless installation or removal.

|                        |   |                  |                 |
|------------------------|---|------------------|-----------------|
| <b>Full Windshield</b> | Com m ander,Com m anderM AX, M averick Trail,M averick Sport, M averick SportM AX | <b>715003655</b> | <b>\$519.99</b> |
|------------------------|---|------------------|-----------------|



- High-impact-resistant durable polycarbonate full windshield.
- Formed polycarbonate construction for enhanced rigidity.
- Formulated to be non-yellowing, non-crazing, non-cracking with excellent UV resistance and optical clarity.
- Seals firmly against the cage and protects rider and passenger from the elements.
- Must be used with rear wind protection.
- Quick and easy toolless installation or removal.

|                                   |   |                  |                 |
|-----------------------------------|---|------------------|-----------------|
| <b>Full Windshield Hardcoated</b> | Com m ander,Com m anderM AX,<br>M averick Trail,M averick Sport,<br>M averick SportM AX | <b>715003656</b> | <b>\$759.99</b> |
|-----------------------------------|---|------------------|-----------------|



- High-impact-resistant Quantum<sup>1</sup> hardcoated polycarbonate full windshield.
- Formed polycarbonate construction for enhanced rigidity.
- Provides excellent optical clarity and better abrasion resistance.
- Seals firmly against the cage and protects rider and passenger from the elements.
- Must be used with rear wind protection.
- Quick and easy tool-less installation or removal.

|                           |   |                  |                 |
|---------------------------|---|------------------|-----------------|
| <b>ProVent Windshield</b> | Com m ander,Com m anderM AX,<br>M averick Trail,M averick Sport,<br>M averick SportM AX | <b>715005210</b> | <b>\$999.99</b> |
|---------------------------|---|------------------|-----------------|



- High-impact-resistant Quantum<sup>1</sup> hardcoated polycarbonate full windshield.
- Controllable vents to manage air flow.
- Channels air into the cabin, defogs windshield, fully closes to eliminate air flow.
- One upper vent and one lower vent with pre-filters.
- Must be used with rear wind protection.
- Provides excellent optical clarity and better abrasion resistance.
- Protects driver and passenger from the elements.
- Quick and easy tool-less installation or removal.
- Not compatible withiperkits and Wet Sounds Stealth 6 Ultra HD Can-Am Edition Sound Bar.
- Not compatible with the Defrost, Heat and Ventilation System.

|                             |   |                  |                   |
|-----------------------------|---|------------------|-------------------|
| <b>PowerFlip Windshield</b> | Com m ander,Com m anderM AX,<br>M averick Trail,M averick Sport,<br>M averick SportM AX | <b>715003658</b> | <b>\$1,269.99</b> |
|-----------------------------|---|------------------|-------------------|



- The PowerFlip Windshield is equipped with electric cylinders that allow the rider to adjust the windshield opening at the touch of a button.
- Windshield is made of hardcoated polycarbonate with a rubber seal contour and a tinted top section.
- Allows you to quickly adapt to changing conditions by adjusting the windshield as you go.
- Can be fully opened for optimal visibility and ventilation, fully closed for maximum protection from the elements, and in between, you have an infinite number of openings.
- Must be used with rear wind protection.

|  |   |                  |                 |
|--|---|------------------|-----------------|
| <b>Windshield Wiper and Washer Kit</b> | Com m ander,Com m anderM AX,<br>M averick Trail,M averick Sport,<br>M averick SportM AX | <b>715003654</b> | <b>\$699.99</b> |
|--|---|------------------|-----------------|



- An ideal way to keep your windshield clear in rain, or while riding through mud and water.
- Includes single-speed wiper, washer fluid dispenser and windshield frame mount.
- Must be used with the Glass Windshield (715003653).
- Requires Overhead Switch Panel (715003669) for installation.
- Not EC compliant.
- Not compatible with ABS equipped vehicles.

|                             |  |                  |                 |
|-----------------------------|--|------------------|-----------------|
| <b>NEW Manual Wiper Kit</b> | Com m ander,Com m anderM AX,M averick<br>Trail,M averick Sport,M averick SportM AX | <b>715009423</b> | <b>\$119.99</b> |
|-----------------------------|--|------------------|-----------------|



- Single manual wiper that can be used to clear windshield of debris.
- Easy to install system that requires no electrical hookup.
- Large ergonomic handle provides a good grip over the entire sweeping surface.
- Compatible with glass and hardcoated windshields that use top mounted wipers.

## Wind Protection

|                             |   |                  |                 |
|-----------------------------|---|------------------|-----------------|
| <b>Side Wind Deflectors</b> | Com m ander,Com m anderM AX,<br>M averick Trail,M averick Sport,<br>M averick SportM AX | <b>715008632</b> | <b>\$219.99</b> |
|-----------------------------|---|------------------|-----------------|



- Clear polycarbonate air deflectors mount on each side of the cage.
- Can be adjusted at three different positions for cabin air flow control when full windshield is installed:
  - 1) Outside deflection to reduce cabin air flow and turbulence.
  - 2) Inside deflection to increase air flow in the cabin.
  - 3) Windshield ventilation to reduce fog.
- Compatible with all windshields.
- Not compatible with full doors.
- Sold in pairs.

|                                  |   |           |          |
|----------------------------------|---|-----------|----------|
| <b>Rear Polycarbonate Window</b> | Commander, CommanderM AX,<br>Maverick Trail, Maverick Sport,<br>Maverick SportM AX (exceptX m rm odel)s | 715006113 | \$499.99 |
|----------------------------------|---|-----------|----------|



- High-impact-resistant polycarbonate window.
- Blocks windshield backdraft or dust and rain from entering braded cabin compartment.
- SportRoofs required for installation.
- Not compatible with BininiRoof, Sun Visor, DragonFire Aluminum Roof and Lonestar Racing Aluminum Roof.

|                         |   |           |          |
|-------------------------|---|-----------|----------|
| <b>Rear Wind Screen</b> | Commander, CommanderM AX,<br>Maverick Trail, Maverick Sport,<br>Maverick SportM AX (exceptX m rm odel)s | 715003664 | \$129.99 |
|-------------------------|---|-----------|----------|



- Full rear mesh screen reduces windshield backdraft for braded cabin compartment.
- Installs quickly and easily on roll cage.
- Large Can-Am branding.

|                        |   |           |          |
|------------------------|---|-----------|----------|
| <b>Soft Rear Panel</b> | Commander, CommanderM AX,<br>Maverick Trail, Maverick Sport,<br>Maverick SportM AX (exceptX m rm odel)s | 715005887 | \$169.99 |
|------------------------|---|-----------|----------|



- Plastic reinforced and weather-resistant rear panel offers good protection from the elements.
- Made of heavy-duty UV-resistant solution-dyed polyester canvas for excellent resistance to tear and abrasion.
- Clear window made of laminated polished vinyl material.
- Resists cold cracking.
- Installs quickly and easily on roll cage.

# MIRRORS



|                     |  |           |          |
|---------------------|--|-----------|----------|
| <b>Side Mirrors</b> | Commander, CommanderM AX,<br>Maverick Trail, Maverick Sport,<br>Maverick SportM AX | 715003639 | \$249.99 |
|---------------------|--|-----------|----------|



- Rugged black nylon construction with coated cast-aluminum mount.
- Dual adjustment (horizontal and vertical) will suit any rider.
- Convex optics deliver optimal field of view (FOV).
- Spring-loaded pivots let mirrors fold back completely.
- Sold in pairs.

|                                |  |           |         |
|--------------------------------|--|-----------|---------|
| <b>Panoramic Center Mirror</b> | Commander, CommanderM AX,<br>Maverick Trail, Maverick Sport,<br>Maverick SportM AX | 715003638 | \$99.99 |
|--------------------------------|--|-----------|---------|



- Wide-angle convex mirror.
- Offers enhanced visibility.
- Can be used with or without roof windshield and with cab enclosure.

|                                      |  |           |         |
|--------------------------------------|--|-----------|---------|
| <b>Sport Panoramic Center Mirror</b> | Commander, CommanderM AX,<br>Maverick Trail, Maverick Sport,<br>Maverick SportM AX | 715004924 | \$95.99 |
|--------------------------------------|--|-----------|---------|



- Convex mirror for wide rearward visibility.
- Ball-joint design with tightening knob for steady multi-angle adjustment.
- Can be used with or without roof windshield.
- Not for road use.

|  |  |           |          |
|--|--|-----------|----------|
| <b>Rear View Mirror and Camera Monitor</b> | Commander, CommanderM AX,<br>Maverick Trail, Maverick Sport,<br>Maverick SportM AX | 715009410 | \$499.99 |
|--|--|-----------|----------|



- Fully waterproof rearview mirror and monitor kit.
- See exactly what you need to see with the multiple camera feeds from the rearview camera.
- This unit replaces the stock rearview mirror (the screen is integrated in the unit's replacement rearview mirror).
- The camera uses infrared light for night vision capabilities.



|                         |                |           |          |
|-------------------------|----------------|-----------|----------|
| <b>Trail Half Doors</b> | Maverick Trail | 715004418 | \$659.99 |
|-------------------------|----------------|-----------|----------|



- Halfdoors made of molded polypropylene to match vehicle's styling.
- Steel frame for high level of rigidity.
- Must have for additional cabin comfort.
- Keep the vehicle narrow in tight trail riding conditions.
- Door Trim is required to complete your door kit (sold separately).
- Standard on 1000 Base and 1000 DPS models.
- Sold in pairs.

|                  |                   |   |            |                   |                    |          |               |           |           |          |             |           |           |          |
|------------------|-------------------|---|------------|-------------------|--------------------|----------|---------------|-----------|-----------|----------|-------------|-----------|-----------|----------|
| <b>Door Trim</b> | Maverick Trail    | <table border="1"> <tr> <td>Can-Am Red</td> <td>Left<br/>705012419</td> <td>Right<br/>705012420</td> <td>\$174.99</td> </tr> <tr> <td>Timless Black</td> <td>705015607</td> <td>705015613</td> <td>\$169.99</td> </tr> <tr> <td>Octane Blue</td> <td>705016447</td> <td>705016449</td> <td>\$169.99</td> </tr> </table> | Can-Am Red | Left<br>705012419 | Right<br>705012420 | \$174.99 | Timless Black | 705015607 | 705015613 | \$169.99 | Octane Blue | 705016447 | 705016449 | \$169.99 |
| Can-Am Red       | Left<br>705012419 | Right<br>705012420  | \$174.99   |                   |                    |          |               |           |           |          |             |           |           |          |
| Timless Black    | 705015607         | 705015613   | \$169.99   |                   |                    |          |               |           |           |          |             |           |           |          |
| Octane Blue      | 705016447         | 705016449   | \$169.99   |                   |                    |          |               |           |           |          |             |           |           |          |



- Matching colored panel for Trail Half Doors.
- Required to complete the Trail Half Doors (sold separately).

|                         |  |           |          |
|-------------------------|--|-----------|----------|
| <b>Sport Half Doors</b> | Commander, Commander MAX, Maverick Trail, Maverick Sport, Maverick Sport MAX | 715006217 | \$659.99 |
|-------------------------|--|-----------|----------|



- Halfdoors made of molded polypropylene to match vehicle's styling.
- Must have for additional cabin comfort.
- Features rounded shape to increase cabin space.
- Standard on all Commander & Maverick Sport models.
- Can be installed on Maverick Trail models for additional cabin space.
- Door Trim is required to complete your door kit (sold separately).
- Sold in pairs.

|                  |  |   |            |                   |                    |          |               |           |           |          |             |           |           |          |
|------------------|--|---|------------|-------------------|--------------------|----------|---------------|-----------|-----------|----------|-------------|-----------|-----------|----------|
| <b>Door Trim</b> | Commander, Commander MAX, Maverick Trail, Maverick Sport, Maverick Sport MAX | <table border="1"> <tr> <td>Can-Am Red</td> <td>Left<br/>705015464</td> <td>Right<br/>705015465</td> <td>\$174.99</td> </tr> <tr> <td>Timless Black</td> <td>705015608</td> <td>705015615</td> <td>\$229.99</td> </tr> <tr> <td>Octane Blue</td> <td>705016448</td> <td>705016450</td> <td>\$229.99</td> </tr> </table> | Can-Am Red | Left<br>705015464 | Right<br>705015465 | \$174.99 | Timless Black | 705015608 | 705015615 | \$229.99 | Octane Blue | 705016448 | 705016450 | \$229.99 |
| Can-Am Red       | Left<br>705015464  | Right<br>705015465  | \$174.99   |                   |                    |          |               |           |           |          |             |           |           |          |
| Timless Black    | 705015608  | 705015615   | \$229.99   |                   |                    |          |               |           |           |          |             |           |           |          |
| Octane Blue      | 705016448  | 705016450   | \$229.99   |                   |                    |          |               |           |           |          |             |           |           |          |



- Matching colored panel for the Sport Half Doors.
- Required to complete the Sport Half Doors (sold separately).
- Sold in pairs.

|                               |  |                   |          |
|-------------------------------|--|-------------------|----------|
| <b>Upper Soft Door Panels</b> | Commander, Commander MAX, Maverick Trail, Maverick Sport, Maverick Sport MAX | 715004718 - Front | \$809.99 |
|                               | Commander MAX, Maverick Sport MAX  | 715004726 - Rear  |          |



- Upper canvas portion of the doors with sturdy steel frame.
- Seals firmly against the cage and protects rider and passenger from the elements.
- Converts halfdoor into fulldoor for a complete cab enclosure.
- Zippered window made of laminated polished vinyl material for added ventilation.
- Easy to remove on hot and sunny days.
- Sport Roof required for installation.

†Not compatible with Trail Half Doors or with the standard half doors on Maverick Trail models.

|  |                |           |          |
|--|----------------|-----------|----------|
| <b>Upper Soft Door Panels</b><br>(Not illustrated) | Maverick Trail | 715003620 | \$809.99 |
|--|----------------|-----------|----------|

- Can only be installed with Trail Half Doors or with the standard half doors on Maverick Trail models.
- Not compatible with Sport Half Doors or with the standard half doors on Maverick Sport models.
- Sport Roof required for installation.



|   |                |           |         |
|---|----------------|-----------|---------|
| <b>Door Seal Kit</b><br><i>(Not illustrated)</i>  | Maverick Trail | 715004773 | \$39.99 |
| <ul style="list-style-type: none"> <li>Improves door sealing from the elements and provides additional cabin comfort.</li> <li>Included in the Soft Cab Enclosure Kit (715003618).</li> <li>Not compatible with Sport Half Doors.</li> <li>Compatible with the Trail Half Doors or with the stock doors on the Maverick Trail.</li> </ul> |                |           |         |

|                                    |                |           |          |
|------------------------------------|----------------|-----------|----------|
| <b>Door Knee Pads with Storage</b> | Maverick Trail | 715003635 | \$164.99 |
|------------------------------------|----------------|-----------|----------|



- Padded door cushion with integrated pocket for storage.
- Protect driver and passenger legs from direct contact with the doors while riding.
- Increase cabin comfort.
- Requires Trail Half Door on 800 Base and 800 DPS models (715004418).
- Offers storage space for small items.
- Sold in pairs.
- Not compatible with Sport Half Doors.

|                                  |  |           |          |
|----------------------------------|--|-----------|----------|
| <b>Door Storage with Padding</b> | Commander, Commander M AX,<br>Maverick Trail, Maverick Sport,<br>Maverick Sport M AX | 715004914 | \$179.99 |
|----------------------------------|--|-----------|----------|



- Weather-resistant door storage bags with integrated padding.
- Holds your gear safely and securely and also protects driver and passenger legs from direct contact with the doors while riding.
- Each bag is designed as a 0.5 gal (2 L) capacity pocket also equipped with inner netting compartments.
- Semi-rigid construction renders them flexible enough to fit odd-shaped loads.
- Easy to install.
- Sold in pairs.
- Bags attach on stock doors of the Maverick Sport or on the Maverick Trail equipped with the Sport Half Doors (715006217).
- Not compatible with stock doors on the Maverick Trail or the Trail Half Doors.

## SEAT ACCESSORIES



|                        |  |                       |          |
|------------------------|--|-----------------------|----------|
| <b>4-Point Harness</b> | Commander, Commander M AX,<br>Maverick Trail, Maverick Sport,<br>Maverick Sport M AX | 715008035 - Driver    | \$284.99 |
|                        |  | 715008036 - Passenger | \$239.99 |



- Exclusive controlled decelerator technology (patent pending) absorbs additional energy in case of accident.
- Designed to offer maximum riding comfort.
- Easy one-click latch and release.
- Not EC compliant.
- ROHVA compliant.
- Requires 4-point harness bar, ROHVA compliant when used in conjunction with Can-Am harness bars.

|                            |                                     |           |          |
|----------------------------|-------------------------------------|-----------|----------|
| <b>4-Point Harness Bar</b> | Commander M AX, Maverick Sport M AX | 715004847 | \$294.99 |
|----------------------------|-------------------------------------|-----------|----------|



- 1.5" (3.8 cm) diameter, thick-walled steel tubing.
- Designed for use with Can-Am 4-Point Harness.
- Not EC compliant.

|                                |  |           |         |
|--------------------------------|--|-----------|---------|
| <b>Seat Belt Shoulder Pads</b> | Commander, Commander M AX,<br>Maverick Trail, Maverick Sport,<br>Maverick Sport M AX | 715002894 | \$45.99 |
|--------------------------------|--|-----------|---------|



- Provide additional riding comfort by preventing seat belt from rubbing on neck and shoulder.
- Fits with stock 3-point seat belts and 4-point harness.
- Easy Velcro installation.
- Can-Am branded.
- Sold in pairs for driver and passenger.

# COMMANDER SKID PLATES

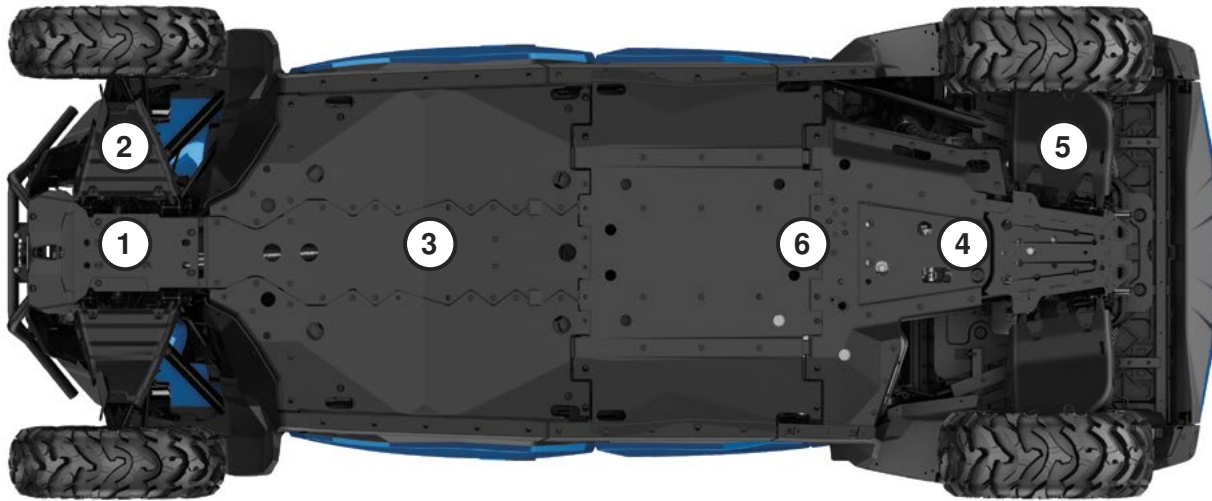

Our plastic plates glide smoothly and silently over obstacles, offering great protection in rough terrain.

- Made of abrasion-resistant thermofomed High Molecular Weight Polyethylene (HMWPE).
- Lighter than aluminum.

- High impact strength.
- Ultra-sturdy 3/8" (10 mm) thickness.

## COMMANDER, COMMANDER MAX

Order your Commander the full protection kit or get parts individually

DPS & XT 700

XT 1000, XT-P & Xmr

### HMWPE Skid Plate Protection Kit

Includes:

- HMWPE Front Skid Plate.
- HMWPE Front A-Arm Protectors.
- HMWPE Rear Skid Plate.
- HMWPE Rear A-Arm Protectors.
- HMWPE Underbelly Plates.
- HMWPE Central Skid Plate.

715006349  
(except MAX)

715006350  
(except MAX)

715006351  
(MAX only)

715007303  
(MAX only)

### Individual HMWPE Skid Plates

|  | DPS & XT 700            | XT 1000, XT-P & Xmr     |
|--|-------------------------|-------------------------|
| ① HMWPE Front Skid Plate   | 715008279               | 715008279               |
| ② HMWPE Front A-Arm Protectors   | 715008276               | 715008277               |
| ③ HMWPE Underbelly Plates<br>Keeps the wheel over clearance.             | 715006273               | 715006273               |
| ④ HMWPE Rear Skid Plate  | 715007302               | 715007302               |
| ⑤ HMWPE Rear A-Arm Protectors  | 715004271               | 715006341               |
| ⑥ HMWPE Central Skid Plate<br>Provides center protection for MAX models. | 715004272<br>(MAX only) | 715004272<br>(MAX only) |

# MAVERICK TRAIL & MAVERICK SPORT SKID PLATES

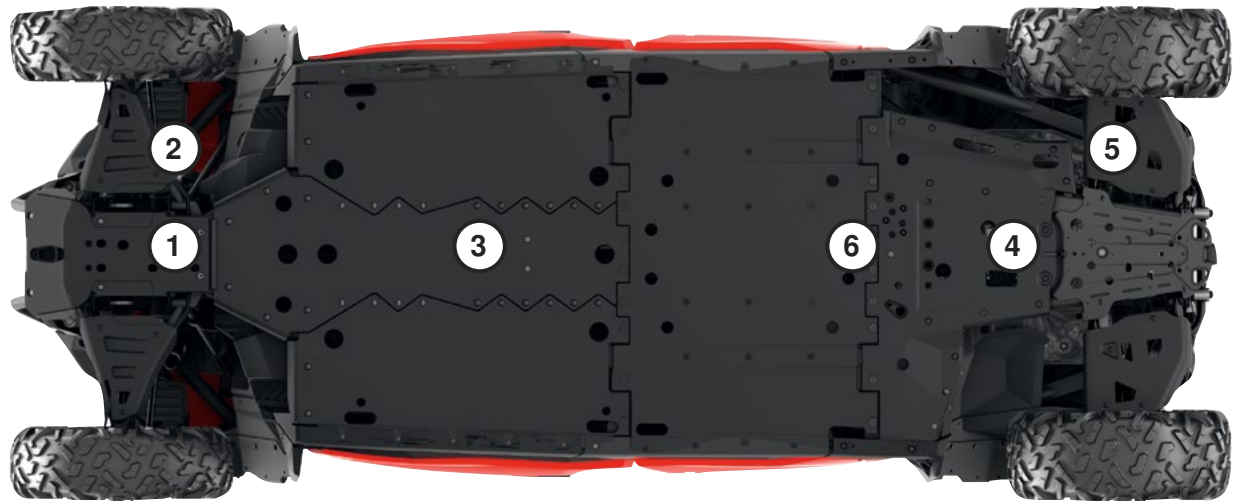

Our plastic plates glide smoothly and silently over obstacles, offering great protection in rough terrain.

- Made of abrasion-resistant thermoformed High Molecular Weight Polyethylene (HMWPE).
- Lighter than aluminum.

- Superior stress crack resistance.
- High impact strength.
- Ultra-sturdy 3/8" (10 mm) thickness.

## MAVERICK SPORT & MAVERICK SPORT MAX MAVERICK TRAIL

Order your Maverick the full protection kit or get parts individually

|  | 2019 Base & DPS        | 2019 Xmr  | 2020 & Up Base & DPS   | 2020 & Up Xmr & Xxc | Any Year Xrc                              |   |
|--|------------------------|-----------|------------------------|---------------------|---|---|
| <b>HMWPE Skid Plate Protection Kit</b>                                   |                        |           |                        |                     |   |   |
| Includes:  |                        |           |                        |                     |   |   |
| -HMWPE Front Skid Plate.   | 715006348 (except MAX) |           | 715006349 (except MAX) |                     |   | 715006346 (2019 & prior)                          |
| -HMWPE Front A-Arm Protectors.   |                        | 715006353 |                        | 715006350           | —   |   |
| -HMWPE Rear Skid Plate.  |                        |           |                        |                     |   |   |
| -HMWPE Rear A-Arm Protectors.  |                        |           |                        |                     |   |   |
| -HMWPE Underbelly Plates.  | 715006352 (MAX only)   |           | 715006351 (MAX only)   |                     |   | 715006347 (2020 & up)                             |
| -HMWPE Central Skid Plate.   |                        |           |                        |                     |   |   |
| <b>Individual HMWPE Skid Plates</b>                                      |                        |           |                        |                     |   |   |
| ① HMWPE Front Skid Plate   | 715008279              | 715008279 | 715008279              | 715008279           | (Standard on Xrc models)                  | 715008279   |
| ② HMWPE Front A-Arm Protectors   | 715008276              | 715008277 | 715008276              | 715008277           | (Standard on Xrc models)                  | 715008278   |
| ③ HMWPE Underbelly Plates<br>Keeps the rollover clearance.               | 715006339              | 715006339 | 715006273              | 715006273           | 715006339 (2019)<br>715006273 (2020 & up) | 715006339 (2019 & prior)<br>715006273 (2020 & up) |
| ④ HMWPE Rear Skid Plate  | 715007302              | 715007302 | 715007302              | 715007302           | 715007302                                 | 715007302   |
| ⑤ HMWPE Rear A-Arm Protectors  | 715004271              | 715006341 | 715004271              | 715006341           | (Standard on Xrc models)                  | 715003699   |
| ⑥ HMWPE Central Skid Plate<br>Provides center protection for MAX models. | 715004272 (MAX only)   | —         | 715004272 (MAX only)   | —                   | —   | —   |

# BUMPERS & GUARDS



## Commander Bumpers

|                          |                             |                         |                 |
|--------------------------|-----------------------------|-------------------------|-----------------|
| <b>X mr Front Bumper</b> | Com m ander,Com m anderM AX | <b>715007248</b> ·Black | <b>\$349.99</b> |
|--------------------------|-----------------------------|-------------------------|-----------------|



- Heavy-duty 1.5" (3.8 cm) diameter steel tube construction.
- Inside and outside anticorrosion coating with durable finish.
- Provides additional front body protection.
- Integrated winch support plate for winch retraction at a higher position for easier access in muddy conditions or for auxiliary lights.
- Allows the installation of front corner protectors.
- Winch not included.

|                     |                             |                  |                 |
|---------------------|-----------------------------|------------------|-----------------|
| <b>Front Bumper</b> | Com m ander,Com m anderM AX | <b>715007631</b> | <b>\$389.99</b> |
|---------------------|-----------------------------|------------------|-----------------|



- Made of 1.5" (3.8 cm) diameter steel tubing with durable powder-coat finish.
- Includes integrated mount points for seamless light installation.
- Compatible with synthetic and steel rope winches and Hawse fairlead.
- Not EC compliant.

|                                |                             |                  |                 |
|--------------------------------|-----------------------------|------------------|-----------------|
| <b>Front Corner Protectors</b> | Com m ander,Com m anderM AX | <b>715006807</b> | <b>\$199.99</b> |
|--------------------------------|-----------------------------|------------------|-----------------|



- Heavy-duty 1.5" (3.8 cm) diameter steel tubing.
- Inside and outside anticorrosion coating with durable powder-coat finish.
- Provide additional protection for vehicle's front corners.
- Requires stock XT, XT-P or X mr bumper.
- Sold in pairs.
- Not EC compliant.

|                     |                             |                  |                 |
|---------------------|-----------------------------|------------------|-----------------|
| <b>Rear Bumpers</b> | Com m ander,Com m anderM AX | <b>715006808</b> | <b>\$289.99</b> |
|---------------------|-----------------------------|------------------|-----------------|



- Rear bumper made of heavy-duty 1.5" (3.8 cm) diameter steel tubing.
- Protects vehicle bodywork and exhaust system.
- Inside and outside anticorrosion coating with durable powder-coat finish.
- Compatible with Mud Flaps.
- Not EC compliant.

## Maverick Trail & Maverick Sport Bumpers

|                           |   |  |                 |
|---------------------------|---|--|-----------------|
| <b>Front Trail Bumper</b> | M averick Trail,M averick Sport,<br>M averick SportM AX | <span style="color: black;">■</span> <b>715003680</b> ·Black<br><span style="color: yellow;">■</span> <b>715003681</b> ·Sunburst<br>Yellow | <b>\$309.99</b> |
|---------------------------|---|--|-----------------|



- Front bumper made of heavy-duty 1.5" (3.8 cm) diameter steel tubing.
- Completes the stock bumper for front coverage and essential vehicle protection for trail riders.
- Inside and outside anticorrosion coating with durable powder-coat finish.
- Includes integrated mount points for seamless light installation.

|                          |   |  |                 |
|--------------------------|---|--|-----------------|
| <b>Rear Trail Bumper</b> | M averick Trail,M averick Sport,<br>M averick SportM AX | <span style="color: black;">■</span> <b>715007109</b> ·Black | <b>\$309.99</b> |
|--------------------------|---|--|-----------------|



- Rear bumper made of heavy-duty 1.5" (3.8 cm) diameter steel tubing.
- Protects vehicle bodywork and exhaust system.
- Inside and outside anticorrosion coating with durable powder-coat finish.

|                                |   |  |                 |
|--------------------------------|---|--|-----------------|
| <b>Front Corner Protectors</b> | M averick Trail,M averick Sport,<br>M averick SportM AX | <span style="color: black;">■</span> <b>715004912</b> ·Black | <b>\$149.99</b> |
|--------------------------------|---|--|-----------------|



- Heavy-duty 1.5" (3.8 cm) diameter steel tubing.
- Inside and outside anticorrosion coating with durable powder-coat finish.
- Provide additional protection for vehicle's front corners.
- Require Front Trail Bumper (715003680 / 715003681) for installation.
- Sold in pairs.



## Rancher Rear Bumper

Maverick Trail, Maverick Sport,  
Maverick SportM AX

715004304

\$419.99



- Heavy-duty protection made of 1.5" (3.8 cm) diameter steel tubing, perfect for farm, ranch and forestry applications.
- Inside and outside anti-corrosion coating with durable powdercoat finish.
- Offers full rear coverage with integrated taillight protectors.
- Not EC compliant.

## S3<sup>+</sup> Front Bumper

Maverick Trail, Maverick Sport,  
Maverick SportM AX

■ 715005121 - Black

\$469.99



- Made of extra durable 1.5" (3.8 cm) diameter steel tubing.
- Inside and outside anti-corrosion coating with durable powdercoat finish.
- Replaces stock bumper and adds superior protection for mud-riding enthusiasts.
- Integrated mount points for lights.
- Hook support anchor allows you to keep the winch hook within easy reach when riding in deep mud.
- "S3 for Can-Am" branded.
- Winch not included.

## S3<sup>+</sup> Rear Bumper

Maverick Trail, Maverick Sport,  
Maverick SportM AX

■ 715005122 - Black

\$579.99



- Made of extra durable 1.5" (3.8 cm) diameter steel tubing.
- Inside and outside anti-corrosion coating with durable powdercoat finish.
- Added heavy-duty protection in extreme driving conditions - protects vehicle bodywork and exhaust system.
- Permits installation of a winch at a higher location to improve accessibility in mud-riding conditions.
- Engineered to sustain heavy winch loads without damaging the vehicle's frame.
- Compatible with Can-Am HD and WARN VRX Winches - Rear Winch Harness (715006008) is required to install winch on the bumper.
- Includes a License Plate Support Mount.
- Not EC compliant.
- "S3 for Can-Am" branded.
- Winch not included.

## Rear Winch Harness

(Not illustrated)

Maverick Trail, Maverick Sport, Maverick SportM AX

715006008

\$219.99

## Rock Sliders

### Rock Sliders

Commander, Maverick Trail, Maverick Sport  
(except X<sub>TC</sub>)  
CommanderM AX, Maverick SportM AX

■ 715003689 - Black

\$429.99

■ 715004754 - Black

\$549.99



- Made of heavy-duty 1.5" (3.8 cm) diameter steel tubing.
- Inside and outside anti-corrosion coating with durable powdercoat finish.
- Protect vehicle's rocker panels and undercarriage against large obstacles.
- Sold in pairs.

## Intrusion Bars

### Front Intrusion Bar

Commander, CommanderM AX,  
Maverick Trail, Maverick Sport,  
Maverick SportM AX

715003872

\$379.99



- Steel intrusion bar matches perfectly with vehicle's styling.
- Inside and outside anti-corrosion coating with durable powdercoat finish.
- Provides additional protection by preventing large objects from entering the driver/passenger area.
- Tube design reduces obstructed lines of sight and blind spots for better visibility.
- Not compatible with Windshields and Soft Door Panels.

### Lonestar Racing Rear Intrusion Bar

Maverick Trail, Maverick Sport

■ 715005134 - Black

\$469.99

■ 715004874 - Can-Am Red

\$479.99



- Race-engineered to Lonestar Racing's trademark standards for toughness, these stylishly crafted accessories will also enhance your vehicle with visual impact.
- Made of 1.5" (3.8 cm) diameter steel tubing with durable powdercoat finish.
- Provides additional protection for driver and passenger.
- Not compatible with the Sport Roof, Rear Panels and Windows, All-Weather Trunk Cover.
- Not compatible with X<sub>TC</sub> models or with the Snorkel Kit.
- Not compatible with S & B particle separator.

## Fender Flares

|                      |                              |                  |                 |
|----------------------|------------------------------|------------------|-----------------|
| <b>Fender Flares</b> | Com m ander, Com m anderM AX | <b>715006814</b> | <b>\$204.99</b> |
|----------------------|------------------------------|------------------|-----------------|



- Fender flares made from injection-molded polypropylene.
- Keep mud and debris out of vehicle.
- Designed for quick and easy installation.
- Front and rear extensions and mounting hardware included.
- Increase vehicle's overall width by 3" (8 cm) when installed on Commander and Commander MAX models.

|                                 |                |                  |                 |
|---------------------------------|----------------|------------------|-----------------|
| <b>2" (51 mm) Fender Flares</b> | Maverick Trail | <b>715004958</b> | <b>\$269.99</b> |
|---------------------------------|----------------|------------------|-----------------|

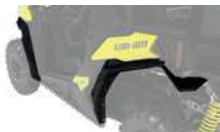

- Extended fender flares made from injection-molded polypropylene.
- Keep mud and debris out of vehicle.
- Designed for quick and easy installation.
- Include front and rear extensions, mounting hardware and Fender Flare Rear Extensions (715004404).
- Increase vehicle's overall width by 3.5" (9 cm).

|                                     |                |                  |                |
|-------------------------------------|----------------|------------------|----------------|
| <b>Fender Flare Rear Extensions</b> | Maverick Trail | <b>715004404</b> | <b>\$49.99</b> |
|-------------------------------------|----------------|------------------|----------------|

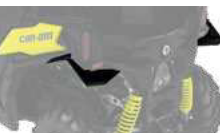

- Help taillight stay clean from debris and mud to remain visible. Can be installed with 2" (51 mm) Fender Flares (715003625).
- Made from injection-molded polypropylene for best fit and finish.
- Sold in pairs.
- Included with the 2" (51 mm) Fender Flares (715004958) and with the Fender Flare Extensions (715004462).

|                                 |  |                  |                 |
|---------------------------------|--|------------------|-----------------|
| <b>3" (76 mm) Fender Flares</b> | Maverick Trail, Maverick Sport, Maverick Sport MAX | <b>715004959</b> | <b>\$239.99</b> |
|---------------------------------|--|------------------|-----------------|



- Fender flares made from injection-molded polypropylene.
- Keep mud and debris out of vehicle.
- Designed for quick and easy installation.
- Include front and rear extensions and mounting hardware.
- Increase vehicle's overall width by 6" (15.3 cm) when installed on Maverick Trail models.
- Standard on Maverick Sport models.

|                                     |  |                  |                 |
|-------------------------------------|--|------------------|-----------------|
| <b>Fender Flare Rear Extensions</b> | Maverick Trail, Maverick Sport, Maverick Sport MAX | <b>715004462</b> | <b>\$269.99</b> |
|-------------------------------------|--|------------------|-----------------|



- Block terrain debris from kicking up onto you as you ride or damage your vehicle thanks to these extra-large Fender Flare Extensions, which also include Rear Extensions (715004404) for added protection from mud/snow, especially when riding with track kits.
- Made from injection-molded polypropylene for best fit and finish.
- Not compatible with 2" (51 mm) Fender Flares.
- Include front and rear extensions.
- For Maverick Trail, must be used with 3" (76 mm) Fender Flares (715004959).
- Standard on Maverick Sport X models.

## Others

|                             |  |                  |                 |
|-----------------------------|--|------------------|-----------------|
| <b>License Plate Holder</b> | Maverick Trail, Maverick Sport, Maverick Sport MAX | <b>715007006</b> | <b>\$114.99</b> |
|-----------------------------|--|------------------|-----------------|



- Supports your license plate on the Rear TrailBumper.
- Plate lights can be relocated on bumper to light up license plate.
- Requires Rear TrailBumper (715007109) for installation.
- EC compliant.

|                              |  |                  |                 |
|------------------------------|--|------------------|-----------------|
| <b>Tail Light Protectors</b> | Maverick Trail, Maverick Sport, Maverick Sport MAX | <b>715003692</b> | <b>\$109.99</b> |
|------------------------------|--|------------------|-----------------|



- Anti-corrosion coating with durable powdercoat finish.
- Rugged style, aggressive look.
- Sold in pairs.
- Not EC compliant.

|                           |  |                  |                 |
|---------------------------|--|------------------|-----------------|
| <b>Radiator Protector</b> | Maverick Trail, Maverick Sport, Maverick Sport MAX | <b>715003700</b> | <b>\$109.99</b> |
|---------------------------|--|------------------|-----------------|

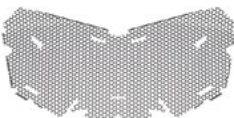

- Perforated steel shield mounted over the radiator face, providing protection from stones and branches.
- Not recommended for winter use.

# LINQ EASY ON, EASY OFF CARGO



## COMMANDERS LinQ ACCESSORIES

### Mounting location and requirements

|  |                            |                              |                                  |                                   |                                  |                     |
|--|----------------------------|------------------------------|----------------------------------|-----------------------------------|----------------------------------|---------------------|
| <ul style="list-style-type: none"> <li>•No tools needed: Quickly install and remove accessories by hand.</li> <li>•Equip your Can-Am for specialized tasks in the field</li> <li>•Sturdy mounting system that holds up to the roughest terrain.</li> </ul> | Vehicle Standard Cargo Box | LinQ Cargo Rack<br>715006815 | Adventure Roof Rack<br>715004095 | Deluxe Headache Rack<br>715006823 | Rear Adventure Rack<br>715006809 | Passenger Seat Base |
|  |                            |                              |                                  |                                   |                                  |                     |

**LinQ Accessories with 16" Base**

- LinQ anchors mounted 16 inches apart, center-to-center.
- Lower loading capacity than the LinQ with 36" base accessories.
- Can be used on Can-Am ATV and SxS vehicles, Can-Am Spyder and Ryker vehicles, Sea-Doo watercraft and Ski-Doo snowmobiles.

|  |                                     |                                     |                                     |     |                                     |   |
|--|-------------------------------------|-------------------------------------|-------------------------------------|-----|-------------------------------------|---|
| LinQ 4.2 Gal Cooler<br>295100698 White<br>219400964 Black                    | LinQ Base Installation<br>715008125 | LinQ Base Installation<br>715008125 | LinQ Base Installation<br>715008125 | Kit |                                     |   |
| LinQ Tool Kit<br>715006829   | No further requirements             | No further requirements             | No further requirements             |     |                                     |   |
| LinQ Tool Box<br>715008111   |                                     |                                     |                                     |     |                                     |   |
| LinQ SR 5.5 Gal (21 L) Bag<br>860202449                                      | LinQ Base Installation<br>715008125 | LinQ Base Installation<br>715008125 | LinQ Base Installation<br>715008125 | Kit | LinQ Base Installation<br>715008125 | LinQ Base Installation<br>715008125         |
| LinQ 4.5 Gal (17 L) Sport Bag<br>860202447                                   |                                     |                                     |                                     |     |                                     | Passenger Seat LinQ Anchor Kit<br>715003951 |
| LinQ Modular Box<br>715005494 (10 L)<br>715007112 (20 L)<br>715006830 (30 L) | No further requirements             | No further requirements             | No further requirements             |     |                                     |   |
| LinQ Roll-Top Bag<br>715008110   | LinQ Base Installation<br>715008125 | LinQ Base Installation<br>715008125 | LinQ Base Installation<br>715008125 | Kit |                                     |   |

**LinQ Accessories with 36" Base**

- Mount on LinQ racks often used by Can-Am ORV vehicles.
- Higher loading capacity than the LinQ with 16" base accessories.
- Usage is limited to Can-Am ORV vehicles.

|  |                  |                         |                  |                  |                  |                  |
|--|------------------|-------------------------|------------------|------------------|------------------|------------------|
| LinQ 12 Gal (45 L) Cargo Box<br>715003879        |                  | No further requirements |                  |                  |                  |                  |
| LinQ 23 Gal (86 L) Trunk Box<br>715004923        |                  |                         |                  |                  |                  |                  |
| LinQ Audio Box<br>715003018                      |                  | No compatibility        |                  |                  |                  |                  |
| LinQ Cooler<br>715004778 Black<br>715004698 Gray | No compatibility |                         | No compatibility | No compatibility | No compatibility | No compatibility |
| LinQOGIO Bag<br>715002923 Black                  |                  | No further requirements |                  |                  |                  |                  |
| LinQ Heavy Duty Basket<br>715001215              |                  |                         |                  |                  |                  |                  |
| LinQ Low Profile Basket<br>715004282             |                  |                         |                  |                  |                  |                  |

### LinQ Holders

|                               |                         |                         |  |  |  |   |
|-------------------------------|-------------------------|-------------------------|--|--|--|---|
| LinQ Gear Grips<br>715005340  | No further requirements | No further requirements | Side wall installation<br>LinQ Adapters<br>715003058 | Side wall installation<br>LinQ Adapters<br>715003058 | Side wall installation<br>LinQ Adapters<br>715003058 | Passenger Seat LinQ Anchor Kit<br>715003951 |
| LinQ Tool Holder<br>715007358 |                         |                         |  |  |  |   |

# MAVERICK LinQ ACCESSORIES

## Mounting location and requirements

|  |                            |                              |                                  |                                 |                                      |                     |
|--|----------------------------|------------------------------|----------------------------------|---------------------------------|--------------------------------------|---------------------|
| <ul style="list-style-type: none"> <li>• No tools needed: Quickly install and remove accessories by hand.</li> <li>• Equip your Can-Am for specialized tasks in standard Cargo Box</li> <li>• Sturdy mounting system that holds up to the roughest terrain.</li> </ul> | Vehicle Standard Cargo Box | LinQ Cargo Rack<br>715003702 | Adventure Roof Rack<br>715004095 | LinQ Pivoting Rack<br>715008297 | All-Terrain Trunk Cover<br>715003701 | Passenger Seat Base |
|--|----------------------------|------------------------------|----------------------------------|---------------------------------|--------------------------------------|---------------------|

### LinQ Accessories with 16" Base

- LinQ anchors mounted 16 inches apart, center-to-center.
- Lower loading capacity than the LinQ with 36" base accessories.
- Can be used on Can-Am ATV and SxS vehicles, Can-Am Spyder and Ryker vehicles, Sea-Doo watercraft and Ski-Doo snowmobiles.

|  |   |                         |   |  |   |   |
|--|---|-------------------------|---|--|---|---|
| LinQ 4.2 Gal Cooler<br>295100698 White<br>219400964 Black                    | LinQ Base Installation Kit<br>715008125 | No compatibility        | LinQ Base Installation Kit<br>715008125 | LinQ Anchor Kit Adapter Kit<br>715004960 | LinQ Base Installation Kit<br>715008125 | Passenger Seat LinQ Anchor Kit<br>715003951 |
| LinQ Tool Kit<br>715006829   | No further requirements                 | No further requirements | No further requirements                 | No further requirements                  | No further requirements                 | No further requirements                     |
| LinQ Tool Box<br>715008111   | LinQ Base Installation Kit<br>715008125 | No compatibility        | LinQ Base Installation Kit<br>715008125 | LinQ Anchor Kit Adapter Kit<br>715004960 | LinQ Base Installation Kit<br>715008125 | Passenger Seat LinQ Anchor Kit<br>715003951 |
| LinQ SR 5.5 Gal (21 L) Bag<br>860202449                                      |   |                         |   |  |   |   |
| LinQ 4.5 Gal (17 L) Sport Bag<br>860202447                                   |   |                         |   |  |   |   |
| LinQ Modular Box<br>715005494 (10 L)<br>715007112 (20 L)<br>715006830 (30 L) | No further requirements                 | No further requirements | No further requirements                 | No further requirements                  | No further requirements                 | No further requirements                     |
| LinQ Roll-Top Bag<br>715008110   | LinQ Base Installation Kit<br>715008125 | No compatibility        | LinQ Base Installation Kit<br>715008125 | LinQ Anchor Kit Adapter Kit<br>715004960 | LinQ Base Installation Kit<br>715008125 | Passenger Seat LinQ Anchor Kit<br>715003951 |

### LinQ Accessories with 36" Base

- Mount on LinQ racks often used by Can-Am ORV vehicles.
- Higher loading capacity than the LinQ with 16" base accessories.
- Usage is limited to Can-Am ORV vehicles.

|  |                  |                  |                  |                         |                  |                  |
|--|------------------|------------------|------------------|-------------------------|------------------|------------------|
| LinQ 12 Gal (45 L) Cargo Box<br>715003879        | No compatibility | No compatibility | No compatibility | No further requirements | No compatibility | No compatibility |
| LinQ 23 Gal (86 L) Trunk Box<br>715004923        |                  |                  |                  |                         |                  |                  |
| LinQ 32 Gal (121 L) Trunk Box<br>715001747       |                  |                  |                  |                         |                  |                  |
| LinQ Audio Box<br>715003018                      |                  |                  |                  |                         |                  |                  |
| LinQ Cooler<br>715004778 Black<br>715004698 Gray |                  |                  |                  |                         |                  |                  |
| LinQOGIO Bag<br>715002923 Black                  |                  |                  |                  |                         |                  |                  |
| LinQ Heavy Duty Basket<br>715001215              |                  |                  |                  |                         |                  |                  |
| LinQ Low Profile Basket<br>715004282             |                  |                  |                  |                         |                  |                  |

### LinQ Holders

|                               |                                |                  |  |                         |   |                         |
|-------------------------------|--------------------------------|------------------|--|-------------------------|---|-------------------------|
| LinQ Gear Grips<br>715005340  | No further requirements        | No compatibility | Side wall installation<br>LinQ Adapters<br>715003058 | No further requirements | LinQ Base Installation Kit<br>715008125 | No further requirements |
| LinQ Tool Holder<br>715007358 | (when installed on side walls) |                  |  |                         |   |                         |



## LinQ Accessories with 16" Base

### LinQ Modular Box



- Allows stacking of other modular boxes to always have the right gear accessible.
- Always have the right box size to fit everything.
- Can be installed on any LinQ base with a 16" width.
- See table for installation location and requirements.

Commander, Commander M AX,  
Maverick Trail, Maverick Sport,  
Maverick Sport M AX

715005494 · (10 L)

\$139.99

715007112 · (20 L)

\$159.99

715006830 · (30 L)

\$179.99

### Thermal Insert for LinQ Modular Box (10 L)



- Insulated liner.
- Fits very well in the LinQ Modular Box (10 L).
- Can contain seven 355 mL cans.
- Keeps ice cold for one day.
- Interior dimensions: 9" L x 17" W x 2 1/2" H.

Commander, Commander M AX,  
Maverick Trail, Maverick Sport,  
Maverick Sport M AX

219401110

\$55.99

### LinQ Tool Box



- High precision injected HDPE construction provides rigidity and durability.
- 5 gal (19 L) maximum capacity.
- Weather-resistant, sealed and lockable cover.
- Easy one-second on/off toolless system.
- All the benefits of LinQ — simple, fast and secure.
- See table for installation location and requirements.

Commander, Commander M AX,  
Maverick Trail, Maverick Sport,  
Maverick Sport M AX

715008111

\$174.99

### LinQ Tool Kit



- Includes:
  - Cutter pliers
  - Long-nose pliers
  - Locking pliers
  - Ratchet wrench 1/2" drive
  - 6" ratchet extension
  - Integrated CVT belt storage location (belt not included)
  - Long-socket 19 mm 1/2" drive - 6 pts
  - Socket 18 mm 1/2" drive
  - Long-socket 17 mm 1/2" drive - 6 pts
  - Socket 15 mm 1/2" drive
  - Socket 13 mm 1/2" drive
  - Socket 10 mm 1/2" drive
  - Socket 8 mm 1/2" drive
  - Combined wrench 19 mm
  - Combined wrench 18 mm
  - Combined wrench 15 mm
  - Combined wrench 13 mm
  - Combined wrench 10 mm
  - Combined wrench 8 mm
  - Socket Torx T30 1/2" drive
  - Socket Torx T20 1/2" drive
  - Breaker bar 1/2" drive
- See table for installation location and requirements.

Commander, Commander M AX,  
Maverick Trail, Maverick Sport,  
Maverick Sport M AX

715006829

\$309.99

### LinQ 4.2 Gal (16 L) Cooler



- All the benefits of LinQ — simple, fast and secure.
- Rotomolded construction for exceptional rigidity and durability.
- Premium-quality foam insulation for optimal ice retention.
- Uses LinQ mounting system (patent US 8777531 and US 8875830).
- Easy one-second on/off toolless system.
- Can contain twenty 355 mL cans.
- Keeps ice cold for three days.
- Exterior dimensions: 13" L x 20" W x 10" H.
- Interior dimensions: 9" L x 17" W x 7" H.
- See table for installation location and requirements.

Commander, Commander M AX,  
Maverick Trail, Maverick Sport,  
Maverick Sport M AX

■ 219400964 · Black  
■ 295100698 · White

\$369.99

### LinQ 4.5 Gal (17 L) Sport Bag



- 17-liter (4.5 US gal, 1,037 cu. in.) capacity.
- Rigid bottom, semi-rigid top.
- See table for installation location and requirements.

Commander, Commander M AX,  
Maverick Trail, Maverick Sport,  
Maverick Sport M AX

860202447

\$204.99

|                                   |   |                  |                 |
|-----------------------------------|---|------------------|-----------------|
| <b>SR 5.5 Gal (21 L) LinQ Bag</b> | Com m ander,Com m anderM AX,<br>M averick Trail,M averick Sport,<br>M averick SportM AX | <b>860202449</b> | <b>\$224.99</b> |
|-----------------------------------|---|------------------|-----------------|



- All the benefits of LinQ – simple, fast and secure.
- Semi-rigid expandable bag.
- 5.5 gal (21 L) capacity.
- Utilizes LinQ mounting system (Patent US 8777531 and US 8875830).
- Easy one-second on/off toolless system.
- See table for installation location and requirements.

|                          |   |                  |                 |
|--------------------------|---|------------------|-----------------|
| <b>LinQ Roll-Top Bag</b> | Com m ander,Com m anderM AX,<br>M averick Trail,M averick Sport,<br>M averick SportM AX | <b>715008110</b> | <b>\$229.99</b> |
|--------------------------|---|------------------|-----------------|



- Fully waterproof roll-top dry bag will securely store and confine your equipment.
- LinQ mounted using heavy-duty rigid plastic base.
- High capacity storage solution (40 L).
- Bottom foam liner for additional equipment protection.
- Integrated handle for easy transportation on/off the vehicle.
- Dimensions: 14" L x 19" W x adjustable H.
- See table for installation location and requirements.

## LinQ Accessories with 36" Base

|   |   |                            |                 |
|---|---|----------------------------|-----------------|
| <b>LinQ Premium Storage Bag by OGIO</b> | Com m ander,Com m anderM AX,<br>M averick Trail,M averick Sport,<br>M averick SportM AX | ■ <b>715002923</b> · Black | <b>\$439.99</b> |
|---|---|----------------------------|-----------------|



- Toolless installation and removal thanks to the LinQ system.
- 17.2 gal (65 L) capacity semi-rigid cargo bag ideal for carrying anything you need on your vehicle.
- Buckle and elastic closure with a rubber seal that protects dust from entering the bag.
- 3-section lid for partial or full access to your bag.
- Inside separators for optimal bag organization.
- See table for installation location and requirements.

|                                     |   |                  |                 |
|-------------------------------------|---|------------------|-----------------|
| <b>LinQ 12 Gal (45 L) Cargo Box</b> | Com m ander,Com m anderM AX,<br>M averick Trail,M averick Sport,<br>M averick SportM AX | <b>715003879</b> | <b>\$319.99</b> |
|-------------------------------------|---|------------------|-----------------|



- LinQ mounted for easy-on, easy-off installation.
- Holds cargo safely and securely while riding.
- See table for installation location and requirements.

|                                     |   |                  |                 |
|-------------------------------------|---|------------------|-----------------|
| <b>LinQ 23 Gal (86 L) Trunk Box</b> | Com m ander,Com m anderM AX,<br>M averick Trail,M averick Sport,<br>M averick SportM AX | <b>715004923</b> | <b>\$369.99</b> |
|-------------------------------------|---|------------------|-----------------|



- LinQ mounted for easy-on, easy-off installation.
- Holds cargo safely and securely while riding.
- See table for installation location and requirements.

|   |   |                  |                 |
|---|---|------------------|-----------------|
| <b>LinQ 11.5 Gal (43 L) Audio Cargo Box</b> | M averick Trail,M averick Sport,<br>M averick SportM AX | <b>715003018</b> | <b>\$759.99</b> |
|---|---|------------------|-----------------|



- An affordable and quick solution for adding music and storage to your next ride.
- The rear installation does not use up any cab space and allows easy listening at an average speed.
- Mounts on/off easily to hold/carry cargo safely and securely.
- Backlit control panel perfect for night riding.
- Water-resistant speakers.
- The Bluetooth® enabled receiver and 6.5" (16.5 cm) speakers are smartly concealed and integrated in the cover.
- Automatic shut-off function protects your battery by turning the system off after 10 minutes of inactivity.
- See table for installation location and requirements.

|                                     |   |   |                 |
|-------------------------------------|---|---|-----------------|
| <b>LinQ 8 Gal (30 L) Cooler Box</b> | Com m ander,Com m anderM AX,<br>M averick Trail,M averick Sport,<br>M averick SportM AX | ■ <b>715004778</b> · Black<br>■ <b>715004698</b> · Gray | <b>\$439.99</b> |
|-------------------------------------|---|---|-----------------|



- LinQ mounted for easy-on, easy-off installation.
- Rotomolded construction provides exceptional rigidity and durability.
- Premium-quality foam insulation for optimal ice retention.
- Integrated, fully removable compartment protects food.
- Robust rubber latches keep the cover tightly closed.
- Weather-resistant.
- Convenient drain plug.
- See table for installation location and requirements.

|                                      |  |   |                 |
|--------------------------------------|--|---|-----------------|
| <b>LinQ 32 Gal (121 L) Trunk Box</b> | Maverick Trail, Maverick Sport, Maverick SportM AX | <b>715001747</b> · Black<br>Rear tail light included) | <b>\$539.99</b> |
|                                      | European Version (EC compliant)                    | <b>715001748</b> ·<br>No rear tail light)             | <b>\$489.99</b> |



- Equipped with the LinQ system, the rear trunk box plugs in and out in seconds.
- 32 gal (121 L) load capacity with unobstructed space to maximize storage room and access to the trunk's interior.
- Made of injection-molded polyethylene, double-walled in critical areas.
- The fully sealed lid protects your belongings from dust, moisture and the elements.
- Trunk Box Panels available in many colors to match your vehicle (sold separately).
- See table for installation location and requirements.

|   |  |  |                |
|---|--|--|----------------|
| <b>LinQ 32 Gal (121 L) Trunk Box Panels</b> | Maverick Trail, Maverick Sport, Maverick SportM AX |  | <b>\$59.99</b> |
|---|--|--|----------------|



- Color panels to match the LinQ 32 gal (121 L) to your vehicle (715001747/715001748).

|  |  |
|--|--|
| <ul style="list-style-type: none"> <li>■ <b>715001391</b> · Black</li> <li>■ <b>715001392</b> · Yellow</li> <li>■ <b>715001395</b> · Viper Red</li> <li>■ <b>715002481</b> · White</li> <li>■ <b>715002480</b> · Light Gray</li> <li>■ <b>715002984</b> · Octane Blue</li> <li>■ <b>715002985</b> · Santa Green</li> <li>■ <b>715002986</b> · Can-Am Red</li> <li>■ <b>715006119</b> · Orange Crush</li> <li>■ <b>715006120</b> · Squadron Green</li> <li>■ <b>715007074</b> · Tundra Green</li> </ul> | European Version (EC compliant). No rear tail light. |
|--|--|

|   |
|---|
| <ul style="list-style-type: none"> <li>■ <b>715001397</b> · Black</li> <li>■ <b>715001398</b> · Yellow</li> <li>■ <b>715002483</b> · White</li> <li>■ <b>715006121</b> · Can-Am Red</li> <li>■ <b>715006122</b> · Santa Green</li> <li>■ <b>715006123</b> · Orange Crush</li> <li>■ <b>715006124</b> · Viper Red</li> </ul> |
|---|

|                               |  |                  |                 |
|-------------------------------|--|------------------|-----------------|
| <b>LinQ Heavy-Duty Basket</b> | Commander, CommanderM AX, Maverick Trail, Maverick Sport, Maverick SportM AX | <b>715001215</b> | <b>\$269.99</b> |
|-------------------------------|--|------------------|-----------------|



- Made of high-strength, low-alloy steel.
- LinQ mount for easy-on, easy-off installation.
- See table for installation location and requirements.

|                                |  |                  |                 |
|--------------------------------|--|------------------|-----------------|
| <b>LinQ Low Profile Basket</b> | Commander, CommanderM AX, Maverick Trail, Maverick Sport, Maverick SportM AX | <b>715004282</b> | <b>\$209.99</b> |
|--------------------------------|--|------------------|-----------------|



- Low profile, open basket increases cargo space.
- Perfect for easy access to tools, rope, winch and power accessories.
- Multiple bungee cord and tie-down anchor points.
- Made of impact-resistant injected polypropylene.
- See table for installation location and requirements.

## LinQ Holders

|                         |  |                  |                |
|-------------------------|--|------------------|----------------|
| <b>LinQ Tool Holder</b> | Commander, CommanderM AX, Maverick Trail, Maverick Sport, Maverick SportM AX | <b>715007358</b> | <b>\$54.99</b> |
|-------------------------|--|------------------|----------------|







- Ultra-versatile toolholder.
- Convenient swivel latch allows tools to be stored in any orientation.
- Sold in pairs.
- See table for installation location and requirements.

|                        |  |                  |                 |
|------------------------|--|------------------|-----------------|
| <b>LinQ Gear Grips</b> | Commander, CommanderM AX, Maverick Trail, Maverick Sport, Maverick SportM AX | <b>715005340</b> | <b>\$144.99</b> |
|------------------------|--|------------------|-----------------|



- Durable and flexible grips provide a custom fit for a variety of items from 1" to 4" (2.5 cm to 10 cm) in diameter.
- Heavy-duty design for carrying bows, fishing poles, rakes, farm tools and more.
- Quick-release button opens grip quickly for easy access to gear.
- Heavy-duty base system built for the toughest adventures.
- Make transporting your tools a snap by combining the Gear Grips with the LinQ system.
- 360° orientation.
- Sold in pairs.
- See table for installation and requirements.



## LinQ Accessories

|  |   |                  |                |
|--|---|------------------|----------------|
| <b>LinQ Adapter</b><br><i>(Not illustrated)</i>                                    | Commander, CommanderM AX,<br>Maverick Trail, Maverick Sport,<br>Maverick SportM AX  | <b>715003058</b> | <b>\$34.99</b> |
| • Sold in pack of 4.   |   |                  |                |
| <b>LinQ Base Installation Kit</b>  | Commander, CommanderM AX,<br>Maverick Trail, Maverick Sport,<br>Maverick SportM AX  | <b>715008125</b> | <b>\$29.99</b> |
|   | • Unique mounting fastener usable on any LinQ system accessory.<br>• Included: 2 cargo LinQ bases and hardware.   |                  |                |
| <b>LinQ Lock</b>   | Commander, CommanderM AX,<br>Maverick Trail, Maverick Sport,<br>Maverick SportM AX  | <b>860201968</b> | <b>\$61.99</b> |
|   | • Simple way to securely lock most LinQ accessories.<br>• Lock cover protects lock from the elements.<br>• Corrosion resistant.<br>• Pack of 1, includes 2 keys.<br>• Not compatible with LinQ 42 US Gal (16 L) Cooler, LinQ ToolBox, LinQ ToolHolder and LinQ GearGrips. |                  |                |
| <b>LinQ Replacement Part</b>   | Maverick Trail, Maverick Sport,<br>Maverick SportM AX   | <b>715001707</b> | <b>\$27.99</b> |
|    | • Unique mounting fastener usable on any LinQ system accessory.<br>• Toolless installation and removal.<br>• Sold in pairs.   |                  |                |
| <b>LinQ Anchor Adapter kit</b>   | Maverick Trail, Maverick Sport,<br>Maverick SportM AX   | <b>715004960</b> | <b>\$75.99</b> |
|  | • Allows the installation of LinQ accessories with 16" base on LinQ racks.<br>• Toolless installation and removal.<br>• LinQ pivoting rack is required for installation.  |                  |                |

# CARGO & STORAGE



## Cargo

|   |   |                  |                 |
|---|---|------------------|-----------------|
| <b>LinQ Cargo Rack</b>  | Commander, CommanderM AX  | <b>715006815</b> | <b>\$459.99</b> |
|   | • Strong, durable steel rack ✓.<br>• Easy and toolless installation with LinQ system .<br>• Allows the installation of LinQ accessories.<br>• Allows multiple level storage on cargo bed.<br>• Helps keep cargo securely in place.<br>• Multiple bungee cord and tie-down points.<br>• Kit includes LinQ Base 36".<br>• 15" clearance under the rack for other cargo.<br>• Not compatible with 715006816. |                  |                 |
| <b>Integrated Tailgate Extension</b>  | Commander, CommanderM AX  | <b>715006810</b> | <b>\$329.99</b> |
|  | • Integrated design that lets the extension fold away inside the tailgate when not needed.<br>• Steel construction for rugged durability.<br>• Not EC compliant.  |                  |                 |
| <b>Tonneau Cover</b>  | Commander, CommanderM AX  | <b>715006816</b> | <b>\$289.99</b> |
|   | • Fitted to cover all of the items in your cargo box.<br>• Prevents splash from entering the cargo box.<br>• Rolls up to the front.<br>• Easily removable for quick access.<br>• Not compatible with accessories that exceed the bed height.  |                  |                 |



## All-Terrain Trunk Cover

Maverick Trail, Maverick Sport (except XM),  
Maverick SportMAX

715003701

\$599.99



- Transforms your rear cargo area into a fully enclosed and weather-resistant car-like trunk box.
- Gas spring assisted opening.
- Integrated mounting location inside the trunk cover for Dome Light (715002455) (sold separately).
- Rotomolded construction provides exceptional rigidity.
- LinQ accessories can be installed on or inside the trunk cover.
- LinQ Base Installation Kit required for installation on the trunk cover.

## Fixed Tailgate

Maverick Trail, Maverick Sport,  
Maverick SportMAX

715004357

\$209.99



- Rigid rotomolded construction.
- Encloses the rear cargo opening perfectly and helps keep cargo securely in place.
- Matches the vehicle's styling.

## Storage

### Soft Storage Bag

Commander, CommanderMAX,  
Maverick Trail, Maverick Sport,  
Maverick SportMAX

715003759

\$179.99



- 11.8 gal (45 L) capacity soft cargo bag designed with vehicle's rear in mind to maximize potential storage.
- 3-section bag.
- Transport gear in a weatherproof bag.

### Storage 2.6 Gal (10 L) Bag

Commander, CommanderMAX,  
Maverick Trail, Maverick Sport,  
Maverick SportMAX

269502121

\$149.99



- Rolltop dry bag for fully protecting your cargo from the elements.

### Overhead Storage Bags

Commander, CommanderMAX,  
Maverick Trail, Maverick Sport,  
Maverick SportMAX

715005018

\$154.99



- Weather-resistant bags, hold your gear safely and securely while riding.
- Include 2 overhead soft bags mounted on a tubular frame that sits between cage and roof.
- 2.4 gal (9 L) total capacity.
- Bin in Roof with sun visor or Sport Roof needed for installation.
- Not compatible with the Complete Wet Sounds Audio System.

### Shoulder Storage Bag

Commander, CommanderMAX,  
Maverick Trail, Maverick Sport,  
Maverick SportMAX

715005019

\$119.99



- Weather-resistant semi-rigid bag holds your gear safely and securely while riding.
- Bag attaches in unused space between the seats to increase your vehicle's cargo capacity.
- 2.8 gal (10.5 L) capacity.

### Removable Central Storage Bag

CommanderMAX, Maverick SportMAX

715004794

\$149.99



- Weather-resistant bag holds your gear safely and securely while riding.
- Both front and rear passengers can access the bag's content.
- Designed as a 1.3 gal (5.2 L) capacity pocket, also equipped with inner netting compartments and side pockets.
- Can be removed in seconds and includes shoulder strap for transportation.
- Perfect to bring your gear on and off your vehicle.

## NEW Passenger Storage Seat Bag

Commander, Commander MAX, Maverick Trail, Maverick Sport, Maverick Sport MAX

715008080

\$249.99



- This weather-resistant bag holds your gear safely and securely while you ride.
- Bag setting on the passenger seat to increase the vehicle's cargo capacity.
- This bag features a 14.5 gal (65 L) storage capacity and is divided into two compartments.
- The top compartment is insulated to keep your beverages cold and includes two cup holders.
- Additional pocket inside for additional storage, such as a cellphone.
- The bottom compartment is accessible from both sides and serves as a large pocket for storing various items.
- The detachable pocket at the front of the bag can be used as a garbage bag.

## Soft Cooler

Commander, Commander MAX, Maverick Trail, Maverick Sport, Maverick Sport MAX

715003728

\$39.99



- Soft cooler made of durable canvas.
- Removable shoulder strap and carry handles.
- Foam insulation and water-resistant interior liner.
- 22 gal (85 L) capacity.

# RACKS & HOLDERS



## Adventure Roof Rack

Commander MAX, Maverick Sport MAX

715004095

\$779.99



- Real cargo solution for packing everything you need to live your off-road experience fully and completely.
- Built with heavy-duty 1.5" (3.8 cm) and 1.25" (3.2 cm) diameter steel tubing.
- Loads of up to 75 lb (34 kg).
- Linq support plates allow for installation of accessories with 1.6" base.
- Integrated mounting points for the installation of the 39" (99 cm) Double Stacked LED Bar (front).
- Features anchor points for spare tire attachment.
- Spare Tire Tie-Downs sold separately.
- Add the Cargo Box Net to secure and confine your cargo in the rack.
- Can be installed without a roof for the Sport Roof only.

## Rear Adventure Rack

Commander, Commander MAX

715006809

\$949.99



- Made of heavy-duty steel.
- Increases the cargo versatility of the vehicle.
- Allows a Commander 2-up to fit a MAX Adventure Roof Rack for Sport Roof or Bimini Roof on top to protect the cargo area.
- Allows a Commander 2-up to fit a MAX Adventure Roof Rack to increase cargo capacity.
- Not compatible with other bed installed accessories.

## Adventure Rack Enclosure

Commander  
Commander MAX

715006818

715008246

\$929.99



- Works with Rear Adventure Rack.
- Rear panel zip-type window with roll-down feature.
- Covers all accessories mounted inside of the Rear Adventure Rack.
- Compatible only with Sport Roof.
- Compatible with Track Kit and Pre-filter only in Pickup configuration.
- Track Kit and Pre-filter are not compatible with the SUV configuration.
- Not compatible with snorkel kits or XRM models.

## Cargo Bed Rails

Commander, Commander MAX

715006824

\$209.99



- Add an integrated tie-down area to your cargo box.
- Added cargo box protection.
- Inside and outside anti-corrosion coating with durable powder-coat finish.
- Heavy-duty 1" (2.5 cm) diameter steel tube construction.
- Adds height to the bed side wall and serves as a tie-down point.
- Sold in pairs.

## Deluxe Headache Rack

Commander, Commander MAX (except XRM models)

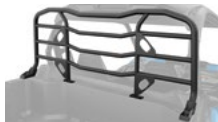

715006823

\$409.99



- Protects cab from cargo load.
- Compatible with cargo bed rails.
- Not compatible with Snorkel Kit (715003705).

|   |  |           |          |
|---|--|-----------|----------|
| LinQ Pivoting Rack  | Maverick Trail, Maverick Sport, Maverick SportM AX   | 715008297 | \$559.99 |
|    | <ul style="list-style-type: none"> <li>LinQ latched rack allows for extra LinQ mounted accessories or the addition of ATV LinQ rack extensions.</li> <li>Includes custom tie-down strap for fast spare tire installation or removal (tire not included).</li> <li>Gas-cylinder pivot action, locks in the raised position.</li> <li>Not compatible with GearRail (715003703), Lonestar Racing and DragonFire tire carrier, Lonestar Racing Number Plate, Rear Intrusion Bars and LinQ Cargo Rack.</li> <li>Compatible with the AllTerrain Trunk Cover.</li> </ul>  |           |          |
| LinQ Rack Extension   | Maverick Trail, Maverick Sport, Maverick SportM AX   | 715003771 | \$254.99 |
|    | <ul style="list-style-type: none"> <li>Made of strong and durable die-cast aluminum.</li> <li>Helps to keep cargo securely in place.</li> <li>Easy and tool-less installation thanks to the LinQ system.</li> </ul>  |           |          |
| LinQ Cargo Rack   | Maverick Trail, Maverick Sport, Maverick SportM AX   | 715003702 | \$429.99 |
|    | <ul style="list-style-type: none"> <li>Made of durable die-cast aluminum and strong aluminum tubing frame.</li> <li>Allows the installation of LinQ Trunk Boxes on top and the addition of more LinQ accessories in cargo box.</li> <li>Easy and tool-less installation thanks to the LinQ system.</li> </ul>  |           |          |
| Spare Tire Carrier  | Maverick Trail, Maverick Sport, Maverick SportM AX   | 715004471 | \$239.99 |
|   | <ul style="list-style-type: none"> <li>Holds spare tire in place.</li> <li>Designed for fast tire removal.</li> <li>Can hold tires up to 30" in diameter (tire is not included).</li> <li>Rear bumper mounted, does not encumber the cargo area.</li> <li>Made of heavy-duty 1.5" (3.8 cm) diameter steel tubing.</li> <li>Inside and outside anti-corrosion coating with durable powder coat finish.</li> <li>Requires Rear Trail Bumper (715007109) or Rear Rancher Bumper (715004304).</li> </ul>   |           |          |
| Cargo Box Net   | Commander, CommanderM AX, Maverick SportM AX   | 715001371 | \$71.99  |
|  | <ul style="list-style-type: none"> <li>Solid net designed to secure and ensure the compact confinement of your Adventure Roof Rack.</li> </ul>   |           |          |
| LinQ Tool and Gun Holder  | Commander, CommanderM AX   | 715005466 | \$529.99 |
|  | <ul style="list-style-type: none"> <li>2-in-1 holding rack can be used both on the job or on the hunt.</li> <li>Includes 5 locations to securely hold tools and guns using rubber grips and retention straps at the top and a rubber mat with gunstock shaped molding at the bottom.</li> <li>Easy to remove, install or reposition using our simple and secure LinQ system.</li> <li>Can be attached at multiple positions along the cargo bed walls, facing inside or outside the bed.</li> <li>Can be attached on the inside of the cargo, behind the cab.</li> <li>Not compatible with Headache Rack.</li> </ul> |           |          |
| LinQ Gun Case   | Commander, CommanderM AX, Maverick Trail, Maverick Sport, Maverick SportM AX   | 715004968 | \$269.99 |
|  | <ul style="list-style-type: none"> <li>Practical design allows you to store shotguns and rifles up to 52" (132 cm) even with optics.</li> <li>Adapt to different weapon shapes and features with foam cushions that can be repositioned.</li> <li>LinQ mounted for efficient and secure storage, locked in place with only a quarter turn.</li> <li>No mount required on Commander and CommanderM AX.</li> <li>Mount kit required for Maverick Trail, Maverick Sport and Maverick SportM AX.</li> </ul>  |           |          |
| LinQ Gun Case Mounting Kit  | Maverick Sport, Maverick SportM AX, Maverick Trail   | 715006444 | \$69.99  |
|  | <ul style="list-style-type: none"> <li>Required to install the Can-Am Gun Case on a Maverick Sport, Maverick SportM AX and Maverick Trail.</li> <li>Allows you to install up to two LinQ gun cases.</li> </ul>   |           |          |

|  |  |                               |                 |
|--|--|-------------------------------|-----------------|
| <p><b>Stronghold Gun Boot Impact<sup>†</sup> by Kolpin<sup>†</sup></b></p>    | <p>Maverick Trail, Maverick Sport, Maverick SportMAX</p>   | <p>705011442</p>              | <p>\$149.99</p> |
| <ul style="list-style-type: none"> <li>Compact low-profile design with Kolpin Stronghold styling securely holds up to 52" (132 cm) long rifles and shotguns with optics.</li> <li>Includes a removable, shock absorbing foam insert.</li> </ul>  | <ul style="list-style-type: none"> <li>Single-handed opening with an attached lid for quick access along with an integrated closure strap.</li> <li>For use with the Kolpin Stronghold Auto-Latch Mount System.</li> </ul>   |                               |                 |
| <p><b>Stronghold Auto-Latch Mount by Kolpin</b></p>    | <p>Maverick Trail, Maverick Sport, Maverick SportMAX</p>   | <p>715003899</p>              | <p>\$88.99</p>  |
| <ul style="list-style-type: none"> <li>Auto-latching design provides quick and secure gun boot attachment to your vehicle.</li> <li>Bracket is made from rugged high-strength, reinforced nylon and coated steel.</li> </ul>   | <ul style="list-style-type: none"> <li>For use with Stronghold Gun Boot (705011442).</li> <li>Requires GearRail (715003703).</li> </ul>  |                               |                 |
| <p><b>Gear Rail</b></p>   | <p>Maverick Trail, Maverick Sport, Maverick SportMAX</p>   | <p>715003703</p>              | <p>\$299.99</p> |
| <ul style="list-style-type: none"> <li>Sturdy gear rail design with C-clamps attached on the roll cage.</li> <li>Offers mounting points for the Stronghold Auto-Latch Mount or for the Universal Saw Press by Kolpin.</li> <li>Can hold up to two gun boots.</li> <li>Not compatible with the Gun Boot 6.0 insert by Kolpin (715001419).</li> </ul>                        |  |                               |                 |
| <p><b>Universal Saw Press by Kolpin</b></p>    | <p>Maverick Trail, Maverick Sport, Maverick SportMAX</p>   | <p>715001423</p>              | <p>\$144.99</p> |
| <ul style="list-style-type: none"> <li>Specially crafted for transporting your chainsaw securely and safely aboard your side-by-side vehicle.</li> <li>Heavy-duty, black powder-coated metal bracket designed to attach any chainsaw model with up to a 20" (51 cm) bar.</li> <li>Rubberpads provide cushion and tight fit.</li> </ul>                                     | <ul style="list-style-type: none"> <li>Hinged design for quick removal.</li> <li>Holds saw in vertical position or 45° angle in either direction.</li> <li>Requires GearRail (715003703).</li> <li>Protective sheath included.</li> </ul>  |                               |                 |
| <p><b>Spare Tire Ratchet Tie-Downs</b></p>   | <p>Commander, CommanderMAX, Maverick Trail, Maverick Sport, Maverick SportMAX</p>  | <p>280000955</p>              | <p>\$32.99</p>  |
| <ul style="list-style-type: none"> <li>3-way ratcheting tie-down strap with loop ends.</li> <li>Designed to securely hold spare tires on accessories equipped with integrated spare tire attachment points.</li> <li>Adjustable to accommodate most common UTV tire sizes.</li> </ul>  | <ul style="list-style-type: none"> <li>Ratchet and junction ring made of durable zinc-plated steel.</li> <li>Required for spare tire attachment on Adventure Roof Rack and LinQ Pivoting Rack.</li> </ul>  |                               |                 |
| <p><b>Heavy-Duty Ratchet Tie-Down</b></p>   | <p>Commander, CommanderMAX, Maverick Trail, Maverick Sport, Maverick SportMAX</p>  | <p>715008308</p>              | <p>\$44.99</p>  |
| <ul style="list-style-type: none"> <li>1,000 lb (454 kg) safe working load.</li> <li>1.5" x 6 in. (38 mm x 152 mm) strap with BRP brands.</li> <li>Deluxe ratchet with rubber handle.</li> <li>Black-coated clip hooks.</li> </ul>   | <ul style="list-style-type: none"> <li>12" (305 mm) webbing included.</li> <li>Pack of two.</li> </ul>   |                               |                 |
| <p><b>Bolt-On<sup>†</sup> Retractable Ratcheting Tie-Downs</b></p>    | <p>Commander, CommanderMAX, Maverick Trail, Maverick Sport, Maverick SportMAX</p>  | <p>295101072</p>              | <p>\$35.99</p>  |
| <ul style="list-style-type: none"> <li>Perfect for transporting your powersport vehicle or securing loads.</li> <li>Mounts easily: Bolts on any flat surface (e.g., truck bed or frame).</li> <li>1" x 6' (2.5 cm x 1.8 m) tie-down strap with heavy-duty stitching that delivers a 500 lb (226 kg) working load strength and 1,500 lb (680 kg) break strength.</li> </ul> | <ul style="list-style-type: none"> <li>Convenient retractable push button automatically slackens, spools and stores away strap, while the ratchet mechanism tightens the strap snugly to secure your vehicle or load into place.</li> <li>Rubber ratcheting handle provides firm grip, and the hook is vinylcoated to protect whatever surface it hooks into.</li> <li>Sold in pairs.</li> </ul> |                               |                 |
| <p><b>Ratchet Tie-Downs</b></p>    | <p>Commander, CommanderMAX, Maverick Trail, Maverick Sport, Maverick SportMAX</p>  | <p>715008309 - Black/Grey</p> | <p>\$24.49</p>  |
| <ul style="list-style-type: none"> <li>400 lb (181 kg) safe working load.</li> <li>1" x 10' (2.5 cm x 3 m) strap with Sea-Doo, SkiDoo and Can-Am logos.</li> <li>Deluxe ratchet with rubber handle.</li> </ul>   | <ul style="list-style-type: none"> <li>Coated S hooks.</li> <li>Pack of 2.</li> </ul>  |                               |                 |



# LIGHTS



|   |  | 2 Choose your lights   |  |  |   |  |   |   |   |  |
|---|--|--|--|--|---|--|---|---|---|--|
| 1 Choose your mount point                                     | BAJA DESIGNS LIGHTS  |  |  |  | CAN-AM LIGHTS   |  |   |   |   |  |
|   | 10" (25 cm) LED Light Bar  | XL Sport LED Lights (sold in pairs)  | Squadron Sport LED Lights (sold in pairs)  | XL80 LED Lights (sold in pairs)  | 10" Double Stacked LED Bar  | 15" Double Stacked LED Bar                             | 39" Double Stacked LED Bar  | 4" Round LED Lights (sold in pairs)   | 3.5" Spot or Flood LED Lights (sold in pairs)                 |  |
| <b>XT&amp;X mr</b><br>Front Bumper (Stock on X, X-P and X mr) | 710006819<br>+<br>715007049<br>(Power Cable)                                       | 710006821<br>+<br>715008865<br>(Power Cable)                                       | 710006820<br>+<br>715008865<br>(Power Cable)                                       | 710005041<br>+<br>715007049<br>(Power Cable)                                       | 715002933<br>+<br>715003670<br>(Power Cable)  | 715002934<br>+<br>715003670<br>(Power Cable)           | NA  | 715002935 (#"Round),<br>715003665 (3.5"Flood) or<br>715003666 (3.5"Spot)<br>+<br>715003670 (Power Cable)              |   |  |
| <b>Trail Bumper</b>   | NA   | 710006821<br>+<br>715008865<br>(Power Cable)                                       | 710006820<br>+<br>715008865<br>(Power Cable)                                       | 710005041<br>+<br>715007049<br>(Power Cable)                                       | 715002933<br>+<br>715003670<br>(Power Cable)  | NA   | NA  | 715002935 (#"Round),<br>715003665 (3.5"Flood) or<br>715003666 (3.5"Spot)<br>+<br>715003670 (Power Cable)              |   |  |
| <b>Commander Front Bumper</b>                                 | 710006819<br>+<br>715007049<br>(Power Cable)                                       | 710006821<br>+<br>715008865<br>(Power Cable)                                       | 710006820<br>+<br>715008865<br>(Power Cable)                                       | 710005041<br>+<br>715007049<br>(Power Cable)                                       | NA  | 715002934<br>+<br>715003670<br>(Power Cable)           | NA  | 715002935 (#"Round),<br>715003665 (3.5"Flood) or<br>715003666 (3.5"Spot)<br>+<br>715003670 (Power Cable)              |   |  |
| <b>Sport Roof &amp; Bin in Roof</b>                           | 710006819<br>+<br>715007049<br>(Power Cable)<br>*Optional<br>Overhead Switch Panel | 710006821<br>+<br>715008865<br>(Power Cable)<br>*Optional<br>Overhead Switch Panel | 710006820<br>+<br>715008865<br>(Power Cable)<br>*Optional<br>Overhead Switch Panel | 710005041<br>+<br>715007049<br>(Power Cable)<br>*Optional<br>Overhead Switch Panel | 715002933<br>+<br>715003670<br>(Power Cable)<br>+<br>715003669<br>(Overhead Switch Panel) | 715002934<br>+<br>715003669<br>(Overhead Switch Panel) | 715004007<br>+<br>715005822<br>(Mounting Kit)<br>*Optional<br>Overhead Switch Panel | 715002935 (#"Round),<br>715003665 (3.5"Flood) or<br>715003666 (3.5"Spot)<br>+<br>715003669<br>(Overhead Switch Panel) |   |  |
| <b>Top Roll Cage</b>  | NA   | NA   | NA   | NA   | NA  | NA   | 715004007<br>+<br>715005822<br>(Mounting Kit)                                       | NA  | NA  |  |
| <b>Sport Roof Back Position</b>                               | NA   | NA   | NA   | NA   | NA  | NA   | NA  | NA  | 715003665 or<br>715003666<br>+<br>715003669<br>+<br>715004910 |  |

### 3 Order

**Order all part numbers in intersecting box**  
\*Note: When installing more than one light kit, additional light power cable or mounting kit is required.

\*All lights are intended for off-road use only.

|  |  |           |          |
|--|--|-----------|----------|
| <b>Baja Designs Light Power Cable</b><br>(Not illustrated) | Commander, Commander MAX, Maverick Trail, Maverick Sport, Maverick Sport MAX | 715008865 | \$199.99 |
|--|--|-----------|----------|

- Required for installation of Baja Designs LED lights onto roof/bumper per.
- Baja Designs XL Sport LED Lights and Baja Designs Squadron Sport LED Lights.

|  |  |           |          |
|--|--|-----------|----------|
| <b>Baja Designs Light Power Cable</b><br>(Not illustrated) | Commander, Commander MAX, Maverick Trail, Maverick Sport, Maverick Sport MAX | 715007049 | \$149.99 |
|--|--|-----------|----------|

- Required for installation of Baja Designs LED lights onto roof/bumper per.
- 10" (25 cm) Baja Designs OnX6 LED Bars and Baja Designs XL80 LED Lights.

### Baja Designs 10" (25 cm) OnX6 LED Light Bar

Com m ander,Com m anderM AX,  
M averick Trail,M averick Sport,  
M averick SportM ax

710006819

\$549.99



12,460 lumens

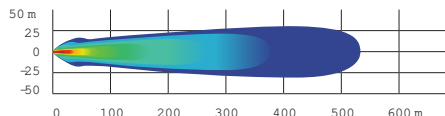

- 108 W lightbarproducing 12,460 lumens.
- Equipped w ith 6 Cree XM -L2 LEDs.
- D riving/com bo lightpattern forsm ooth blend oflight forboth near field applications and distance.

- Dualintensity (high/low) settings.
- Requires Baja Designs LightPowerCable.
- See table for installation location and requirements.

### Baja Designs XL80 LED Lights

Com m ander,Com m anderM AX,  
M averick Trail,M averick Sport,  
M averick SportM ax

710005041

\$1,039.99



9,500 lumens

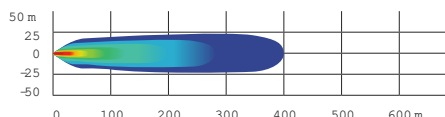

- 80 W perspotproducing 9,500 lumens.
- Equipped w ith 4 Cree XHP50 LEDs perspot.
- Dualintensity (high/low) settings.
- D riving/com bo lightpattern forsm ooth blend oflight forboth near field applications and distance.

- Require Baja Designs LightPowerCable.
- Sold in pairs.
- D im ensions:4.5" x 4.5" (11.4 cm x 11.4 cm).
- See table for installation location and requirements.

### Baja Designs Squadron Sport LED Lights

Com m ander,Com m anderM AX,  
M averick Trail,M averick Sport,  
M averick SportM ax

710006820

\$299.99



3,150 lumens

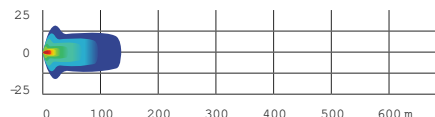

- 26 W perspotproducing 3,150 lumens.
- Equipped w ith 4 Cree XP-G2 LEDs perspot.
- W ide com ering lightpattern designed specifically for com ering, dustand/orfog conditions.

- Require Baja Designs LightPowerCable.
- Sold in pairs.
- D im ensions:3" x 3" (7.6 cm x 7.6 cm).
- See table for installation location and requirements.

### Baja Designs XL Sport LED Lights

Com m ander,Com m anderM AX,  
M averick Trail,M averick Sport,  
M averick SportM ax

710006821

\$519.99



3,150 lumens

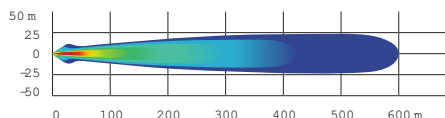

- 26 W perspotproducing 3,150 lumens.
- Equipped w ith 4 Cree XP-G2 LEDs perspot.
- H igh Speed Spot features a longerand narrowerbeam focus for illumination fartherdown.

- Require Baja Designs LightPowerCable.
- Sold in pairs.
- D im ensions:4.5" x 4.5" (11.4 cm x 11.4 cm).
- See table for installation location and requirements.

### 10" (25 cm) Double Stacked LED Light Bar (60 W)

Com m ander,Com m anderM AX,  
M averick Trail,M averick Sport,  
M averick SportM AX

715002933

\$369.99



5,400 lumens

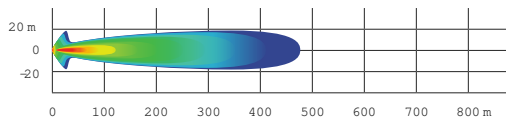

- Equipped w ith twelve 5 W Cree LEDs.
- 5,400 lumens.
- Packs a big punch for its size.
- Rugged and waterproof.
- Can be installed in stock XT and XTP bumpers.

- Requires lightpowercable for installation.
- Lights up to more than 1,500 ft (460 m) in frontofthe vehicle and around 65 ft (20 m) wide on each side.
- EC com pliant.
- See table for installation location and requirements.

### 15" (38 cm) Double Stacked LED Light Bar (90 W)

Commander, CommanderM AX,  
Maverick Trail, Maverick Sport,  
Maverick SportM ax

715002934

\$449.99



8,400  
lumens

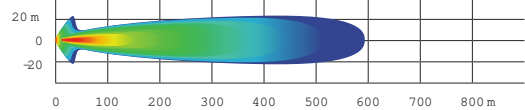

- Equipped with 18 5W Cree LEDs.
- 8,400 lumens.
- Complements the LightRacks and most bumpers.
- Rugged and waterproof.

- Lights up to more than 1,900 ft (580 m) in front of the vehicle and around 65 ft (20 m) wide on each side.
- EC compliant.
- See table for installation location and requirements.

### 39" (99 cm) Double Stacked LED Light Bar (270 W)

Commander, CommanderM AX,  
Maverick Trail, Maverick Sport,  
Maverick SportM ax

715004007

\$879.99



24,300  
lumens

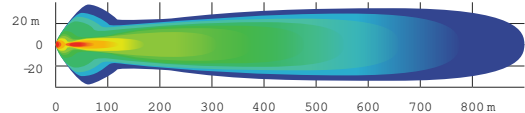

- Equipped with 54 5W Cree LEDs.
- 24,300 lumens.
- Lights up to more than 2,900 ft. (900 m) in front of the vehicle and around 115 ft. (35 m) wide on each side.
- Compatible on the Adventure Roof Rack.

- Maverick Trail, Maverick Sport, Maverick SportM AX: Requires Light Mounting Kit for 39" (99 cm) LED Light Bar (715005822) and/or Lonestar Racing Mounts for 39" (99 cm) Double Stacked LED Light Bar (715004877) for installation.
- Commander 2021 & up: Requires Light Mounting Kit for 39" (99 cm) LED Light Bar (715005822) and/or Lonestar Racing Mounts for 39" (99 cm) Double Stacked LED Light Bar (715004877) for installation.
- See table for installation location and requirements.

### 4" (10 cm) Round LED Lights (2 x 25 W)

Commander, CommanderM AX,  
Maverick Trail, Maverick Sport,  
Maverick SportM ax

715002935

\$449.99



1,800  
lumens

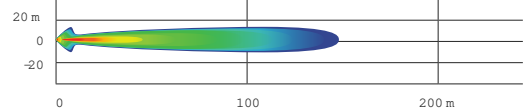

- 25 W LED spotlights.
- 1,800 lumens.
- Rugged and waterproof.
- Includes basic wiring and switch.
- Can-Am branded grill.

- Requires light power cable.
- Sold in pairs.
- Not EC compliant.
- See table for installation location and requirements.

### 3.5" (9 cm) LED Driving Lights (2 x 14 W)

Commander, CommanderM AX,  
Maverick Trail, Maverick Sport,  
Maverick SportM ax

715003666

\$254.99



1,260  
lumens

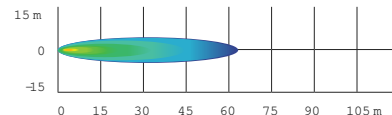

- 14 W LED lights producing 1,260 lumens each.
- Spot lens for a narrow and long light beam spread, ideal when driving at higher speeds.
- Equipped with six high-power LEDs in a heavy-duty die-cast aluminum housing.

- Features two attachment points. If one attachment point fails due to a collision, rotate to the next channel point and remove the light.
- Sold in pairs.
- EC compliant.
- See table for installation location and requirements.

### 3.5" (9 cm) LED Flood Lights (2 x 14 W)

Commander, CommanderM AX,  
Maverick Trail, Maverick Sport,  
Maverick SportM ax

715003665

\$254.99



1,260  
lumens

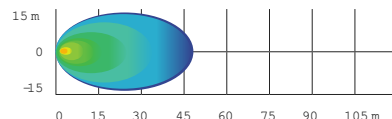

- 14 W LED lights producing 1,260 lumens each.
- Flood lens for a wide light beam spread, ideal for working applications like plowing or coming in. Suitable for dusty or foggy riding conditions.
- Equipped with six high-power LEDs in a heavy-duty die-cast aluminum housing.

- Features two attachment points. If one attachment point fails due to a collision, rotate to the next channel point and remove the light.
- Sold in pairs.
- EC compliant.
- See table for installation location and requirements.

### Light Power Cable

(Not illustrated)

Com m ander,Com m anderM AX,  
M averick Trail,M averick Sport,  
M averick SportM AX

715003670

\$59.99

- Powercable for installation of compatible Can-Am light kits on front bumpers or roof.

### LED Headlights Assembly

Com m ander,Com m anderM AX,  
M averick Trail,M averick Sport,  
M averick SportM AX

715003667

\$849.99



- The headlights in this upgrade kit draw a maximum of 40 W (2 x 20 W) of power while providing brighter light output.
- Lower power consumption and longer lasting than standard halogen bulbs.

### LED Signature Lights

Com m ander,Com m anderM AX

715006896

\$254.99



- The stylish LED set adds a finishing touch, accentuating its aggressive stance.

### Can-Am LED Signature Lights

M averick Trail,M averick Sport,  
M averick SportM AX

715003673

\$254.99



- Add style with a more aggressive look.
- Use bright and energy efficient LEDs.
- Do not give additional lighting for driving.

### Dome Light

Com m ander,Com m anderM AX,  
M averick Trail,M averick Sport,  
M averick SportM AX

715002455

\$84.99



- LED array integrates perfectly with vehicle.
- Wiring included.
- Can be installed on cage, Sport Roof or All Terrain Trunk Cover.

### Mounting Kit for 39" (99 cm) LED Light Bar

(Not illustrated)

Com m ander,Com m anderM AX,  
M averick Trail,M averick Sport,  
M averick SportM AX

715005822

\$124.99

- Required for installation of the 39" (99 cm) double stacked LED Light Bar.
- Includes wiring and support bracket.
- Light Support Bar required for installation.

### Roof Power Cable

(Not illustrated)

Com m ander,Com m anderM AX,  
M averick Trail,M averick Sport,  
M averick SportM AX

715003094

\$59.99

- Brings power from the battery.
- Required for installation of some electrical accessories.

### Rear Lights Power Cable

(Not illustrated)

Com m ander,Com m anderM AX,  
M averick Trail,M averick Sport,  
M averick SportM AX

715004910

\$59.99

- Powercable that allows you to install rear cargo lights on your vehicle.
- Use in conjunction with the 3.5" (9 cm) LED Flood Lights (2 x 14 W) (sold separately).
- This set-up will illuminate your rear cargo area and surroundings.
- Sport Roof and Overhead Switch Panel (715003669) required.



# AUDIO & COMMUNICATION SYSTEMS





## Audio

|   |  |                  |                 |
|---|--|------------------|-----------------|
| <b>Complete Wet Sounds<sup>+</sup> Audio System</b>                               | Commander, Commander MAX,<br>Maverick Trail, Maverick Sport,<br>Maverick Sport MAX   | <b>715003672</b> | <b>\$999.99</b> |
|  | <ul style="list-style-type: none"> <li>Orchestrated for outstanding sound quality and the playlists of champions.</li> <li>Built-in 200 W amplifier with D-Bass Tech for improved low end bass response.</li> <li>Built-in Bluetooth<sup>®</sup> connectivity with source control.</li> <li>Aux input allows for use with non-Bluetooth devices.</li> <li>Turns itself off after 10 minutes of inactivity to save battery power.</li> <li>Designed to be Can-Am<sup>®</sup>-tough in the most demanding riding conditions.</li> <li>Includes 4.5" (11.4 cm) front and 6.5" (16.5 cm) rear roll-cage mounted stereo speakers and console integrated backlit control panel.</li> </ul> |                  |                 |

|   |  |                  |                 |
|---|--|------------------|-----------------|
| <b>Wetsound Stealth XT 6 Can-Am Edition Sound Bar</b>                             | Commander, Commander MAX,<br>Maverick Trail, Maverick Sport,<br>Maverick Sport MAX   | <b>715008282</b> | <b>\$759.99</b> |
|  | <ul style="list-style-type: none"> <li>Built-in Bluetooth connectivity with source control.</li> <li>Built-in Broadcast mode.</li> <li>Backlit control panel with integrated LED RGB cabin lights.</li> <li>Integrated LED Dome.</li> <li>IP67 rated RF wireless remote control.</li> <li>3.5 Aux Input/Output.</li> <li>Built-in 300 W Class D Amplifier.</li> <li>4 marine-rated 3" full range drivers.</li> <li>2 marine-rated 1" tweeters.</li> <li>Operating voltage: 12 V.</li> <li>IP rated: IP67.</li> <li>Length: 21.31"</li> <li>Width: 4.04"</li> <li>Height: 3.85"</li> <li>Sound Bar Mounting Kit required for installation.</li> </ul> |                  |                 |

|   |  |                  |                |
|---|--|------------------|----------------|
| <b>Sound Bar Mount Kit</b><br><i>(Not illustrated)</i>  | Commander, Commander MAX,<br>Maverick Trail, Maverick Sport,<br>Maverick Sport MAX | <b>715004745</b> | <b>\$97.99</b> |
| * Required mount kit for the Wetsounds Stealth 6 Ultra HD Can-Am Edition Sound Bar (715008282). |  |                  |                |

|   |   |                  |                 |
|---|---|------------------|-----------------|
| <b>Can-Am Subwoofer</b>   | Commander, Commander MAX,<br>Maverick Trail, Maverick Sport,<br>Maverick Sport MAX  | <b>715006359</b> | <b>\$759.99</b> |
|  | <ul style="list-style-type: none"> <li>Powerful Wetsounds 8" Subwoofer speaker box that fits in the glove box.</li> <li>Easy plug-and-play connections to Wetsounds audio system.</li> <li>Sturdy construction, tough enough to withstand harsh environments and sealed against moisture and dirt.</li> <li>350 W amplifier and wiring included.</li> </ul> |                  |                 |

|   |  |                  |                 |
|---|--|------------------|-----------------|
| <b>Electronic Device Holder</b>   | Commander, Commander MAX,<br>Maverick Trail, Maverick Sport,<br>Maverick Sport MAX   | <b>715005212</b> | <b>\$199.99</b> |
|  | <ul style="list-style-type: none"> <li>A great in-ride entertainment system platform.</li> <li>Robust injected polypropylene construction allows for right fit and easy installation.</li> <li>Adjustable unit safely holds most tablets and smartphones measuring between 5.1" (13 cm) and 10" (25.4 cm) (with protective case).</li> <li>Allows the installation of Garmin Montana 680T GPS.</li> <li>Perfectly complements the Wetsounds audio system or Rugged Radios Intercom System to play music with your device.</li> <li>Integrated storage (2.5 gal / 9.5 L capacity) with access to the dash 12V outlet for device charging.</li> <li>Integrated mounting location for RAM mounts.</li> <li>Not compatible with Defrost, Heat and Ventilation System (715003678).</li> </ul> |                  |                 |

## Communication Systems

|   |  |                           |                 |
|---|--|---------------------------|-----------------|
| <b>Rugged Radios Helmet Headset Kit for Rear Passengers</b>                         | With Rugged Radios Intercom System   | <b>715004380</b> -US ONLY | <b>\$229.99</b> |
|  | <ul style="list-style-type: none"> <li>Additional 12' (3.7 m) cables and Helmet Speaker/Mic Kits to upgrade your 2-person intercom system to a 4-person system.</li> </ul> <p>#Power Cable (715003094) is required for installation on MAX models.</p> |                           |                 |

# ELECTRICAL & ELECTRONIC ACCESSORIES



## Electrical

|   |  |                  |                   |
|---|--|------------------|-------------------|
| <b>Defrost, Heat and Ventilation System</b> | Commander, Commander M AX,<br>Maverick Trail, Maverick Sport,<br>Maverick Sport M AX | <b>715003678</b> | <b>\$1,109.99</b> |
|---|--|------------------|-------------------|



- Best integrated system on the market with 3 ventilation speeds and in-dash adjustable temperature.
- Adjustable/directional vents.
- 5 vents specially positioned for better windshield defrosting and passenger comfort.
- Automatic-style heater core and fan for best heating performance.
- Smart-Lok equipped vehicles require Adapter Kit (715007241).
- Not compatible with the ProVent Windshield.

|                              |  |                  |                 |
|------------------------------|--|------------------|-----------------|
| <b>Heated Steering Wheel</b> | Commander, Commander M AX,<br>Maverick Trail, Maverick Sport,<br>Maverick Sport M AX | <b>715004283</b> | <b>\$469.99</b> |
|------------------------------|--|------------------|-----------------|



- Ruggedly constructed steering wheel designed to withstand cold conditions while channeling heat directly to your hands.
- Perfect for making hand mobility and grip readily available, e.g., hunting, manual farming.
- Replaces stock steering wheel.
- This kit includes the heated steering and in-dash switch.
- Heated Accessories Wiring Harness (710005757) is required.
- Draws a maximum of 45 W and 3.2 A at 13.5 V.

|                              |  |                  |                 |
|------------------------------|--|------------------|-----------------|
| <b>Heated Grab Bar Cover</b> | Commander, Commander M AX,<br>Maverick Trail, Maverick Sport,<br>Maverick Sport M AX | <b>715004500</b> | <b>\$254.99</b> |
|------------------------------|--|------------------|-----------------|



- Made tough to hold up to the stresses of rough riding, this heated cover will keep your passenger's hands warm and securely gripped during long, cold outings.
- Easy to install and remove.
- This kit includes the heated grab bar cover and in-dash switch.
- Heated Accessories Wiring Harness (710005757) is required.
- Draws a maximum of 25 W and 1.8 A at 13.5 V.

|                    |  |                  |                 |
|--------------------|--|------------------|-----------------|
| <b>Seat Heater</b> | Commander, Commander M AX,<br>Maverick Trail, Maverick Sport,<br>Maverick Sport M AX | <b>715006112</b> | <b>\$139.99</b> |
|--------------------|--|------------------|-----------------|



- 25 W seat heater delivers chill-free riding comfort.
- High/low temperature settings allow you to control the desired degree of warmth.
- This kit includes one carbon fiber seat heater, foam sheet and in-dash switch.
- Installs directly in the original seat cushion.
- Heated Accessories Wiring Harness (710005757) is required for front seat installation.
- Heated Accessories Wiring Harness (715006004) is required for rear seat installation.

|                            |  |                  |                |
|----------------------------|--|------------------|----------------|
| <b>Heated Visor Outlet</b> | Commander, Commander M AX,<br>Maverick Trail, Maverick Sport,<br>Maverick Sport M AX | <b>715001246</b> | <b>\$56.99</b> |
|----------------------------|--|------------------|----------------|



- Strategically positioned on vehicle to maintain your agility.
- Optional visor outlet that delivers fog-free riding.
- Quick and easy installation.
- Sold individually.
- Heated Visor not included.

|  |  |                  |                 |
|--|--|------------------|-----------------|
| <b>Heated Accessories Wiring Harness</b><br><i>(Not illustrated)</i> | Commander, Commander M AX,<br>Maverick Trail, Maverick Sport,<br>Maverick Sport M AX | <b>710005757</b> | <b>\$119.99</b> |
|--|--|------------------|-----------------|

- Electric harness required to hook up and operate front heated seats, heated steering wheel and heated grab bar.

|  |                                     |                  |                 |
|--|-------------------------------------|------------------|-----------------|
| <b>Heated Accessories Wiring Harness</b><br><i>(Not illustrated)</i> | Commander M AX, Maverick Sport M AX | <b>715006004</b> | <b>\$184.99</b> |
|--|-------------------------------------|------------------|-----------------|

- Electric harness required to hook up and operate rear heated seats.

|   |  |                  |                 |
|---|--|------------------|-----------------|
| <b>Heater Adapter Kit for Smart-Lok</b><br><i>(Not illustrated)</i> | Commander, Commander M AX,<br>Maverick Trail, Maverick Sport,<br>Maverick Sport M AX | <b>715007241</b> | <b>\$144.99</b> |
|---|--|------------------|-----------------|

- Adapter kit to fit heating system on Smart-Lok equipped vehicles.

## Electronic

### NEW Cellphone Holder

Com m ander,Com m anderM AX,M averick Trail,M averick Sport,M averick SportM AX

715008786

\$99.99



- Water resistant door allows for perfect phone positioning.
- Features capacitive and resistive touch screen technology.
- Spring system in back plate automatically adjusts for thickness.
- Fits all cellphones within 7.2" (185 mm) x 3.3" (85 mm) x 0.6" (15 mm) dimensions.
- Works with almost all charger wires.
- Does not include cellphone or charging wires.
- Requires the RAM GPS Mount (715003325) bolted directly on the dashboard for the Cellphone Holder to be supported. RAM GPS Mount (715003325) can also be installed on the Electronic Device Holder (715005212).

### RAM GPS Mount

Com m ander,Com m anderM AX, M averick Trail,M averick Sport, M averick SportM AX

715003325

\$68.99



- Allows for GPS integration onto vehicle.
- Standard AMP S hole pattern for Garmin Cradle.

### Overhead Switch Panel

Com m ander,Com m anderM AX, M averick Trail,M averick Sport, M averick SportM AX

715003669

\$249.99



- Fully integrated Overhead Switch Panel gives additional switch spots for electrical accessories.
- Required for Can-Am lights installation on the roof and for other top-mounted electrical accessories.
- Optional for Baja Designs lights.
- Requires Sport Roof for Bin in the Roof with Sun Visor for installation.

### 30 Ah Battery Holder

Com m ander,Com m anderM AX, M averick Trail,M averick Sport, M averick SportM AX

715004431

\$58.99



- Fixation plate designed to hold the 30 Ah Battery (615176151).
- 30 Ah Battery sold separately.

### Quick Connect Battery Cable

Com m ander,Com m anderM AX, M averick Trail,M averick Sport, M averick SportM AX

715005408

\$10.49



- Quickly and easily connect and charge different batteries with your charger.
- Included in the Battery Charger/Maintainer.
- Sold individually.

### Quick Connect Cable with Battery Indicator

Com m ander,Com m anderM AX, M averick Trail,M averick Sport, M averick SportM AX

715006055

\$22.49



- Quickly and easily connect and charge different batteries with your charger.
- 3-color LED indicator provides constant battery health indication.
- Sold individually.

|  |   |                  |                 |
|--|---|------------------|-----------------|
| <b>Digitally Encoded Security System (D.E.S.S.) Keys</b> | Maverick Trail, Maverick Sport 2024 (except 700 engine) | <b>715002458</b> | <b>\$239.99</b> |
|--|---|------------------|-----------------|



- Top-security anti-theft protection for your vehicle.
- Encrypted chip technology restricts access to your vehicle's electronic ignition system.
- One vehicle/one code.
- A vibration/shock-resistant ball-and-socket design that ensures a reliable connection.
- 3 programmable modes:
  - Work mode: Limits vehicle speed to 40 kph (25 mph) but does not limit engine torque.
  - Normal mode: Limits vehicle speed to 70 kph (44 mph) and 50% torque reduction.
  - Performance mode: No restrictions.

|   |                                       |                  |                 |
|---|---------------------------------------|------------------|-----------------|
| <b>NEW Digitally Encoded Security System (D.E.S.S.™) Keys</b> | Maverick Trail 2024 (with 700 engine) | <b>715009300</b> | <b>\$239.99</b> |
|---|---------------------------------------|------------------|-----------------|



- Top-security anti-theft protection for Can-Am vehicles.
- The encrypted chip technology restricts access to the unit's electronic ignition system.
- One code per vehicle.
- Features a vibration/shock-resistant ball-and-socket design that ensures a reliable connection.
- Comes with three programmable keys, including:
  - Work key: Configurable vehicle speed limit between 30 kph (18 mph) and maximum vehicle speed that does not limit engine torque.
  - Normal key: Limits vehicle speed to 70 kph (44 mph) and 50% torque reduction on Maverick Trail models.
  - Performance key: No restrictions.

# WINCHES & HITCHES



## Can-Am HD Winches

|                             |  |                  |                 |
|-----------------------------|--|------------------|-----------------|
| <b>Can-Am HD 4500 Winch</b> | Commander, Commander MAX, Maverick Trail, Maverick Sport, Maverick Sport MAX | <b>715006416</b> | <b>\$359.99</b> |
|-----------------------------|--|------------------|-----------------|



- Ergonomic clutch handle.
- Rugged all-steel gears and bushings form core torque and durability.
- Automatic 100% load-holding brake.
- Sealed solenoid for all-weather protection.
- Weathersealed corded remote and dash-mounted switch.
- EC compliant.
- Pulling strength capability of 4,500 lb (2,041 kg).
- 43' of 1/2" (13.1 m of 6.35 mm) wire steel cable.
- Heavy-duty 4-way roller fairlead.
- Winch Electrical Harness (715003777) is required for installation.
- Commander X m r front bumper requires Winch Electrical Harness (715008218).

|                               |  |                  |                 |
|-------------------------------|--|------------------|-----------------|
| <b>Can-Am HD 4500-S Winch</b> | Commander, Commander MAX, Maverick Trail, Maverick Sport, Maverick Sport MAX | <b>715006417</b> | <b>\$479.99</b> |
|-------------------------------|--|------------------|-----------------|



- Ergonomic clutch handle.
- Rugged all-steel gears and bushings form core torque and durability.
- Automatic 100% load-holding brake.
- Sealed solenoid for all-weather protection.
- Weathersealed corded remote and dash-mounted switch.
- Pulling strength capability of 4,500 lb (2,041 kg).
- 50' of 1/2" (15.2 m of 6.35 mm) synthetic rope.
- Corrosion-proof aluminum housing fairlead.
- Winch Electrical Harness (715003777) is required for installation.
- Commander X m r front bumper requires Winch Electrical Harness (715008218).

## WARN<sup>+</sup> VRX Winches

|                          |  |                  |                 |
|--------------------------|--|------------------|-----------------|
| <b>WARN VRX 45 Winch</b> | Commander, Commander MAX, Maverick Trail, Maverick Sport, Maverick Sport MAX | <b>715006110</b> | <b>\$609.99</b> |
|--------------------------|--|------------------|-----------------|





- Extreme IP68-rated waterproof sealing keeps the elements out.
- Durable aluminum construction.
- Black powder-coated finish and stainless steel fasteners for corrosion resistance.
- Robust new clutch design based on 70+ years of WARN 4WD hub lock know-how.
- Load-holding brake for great control.
- Smooth and reliable aluminum three-stage planetary gear train.
- Dash-mounted rocker control.
- Limited lifetime warranty (mechanical), 3-year warranty (electrical).
- Pulling strength capability of 4,500 lb (2,041 kg).
- 50' of 1/2" (15 m of 6.35 mm) wire steel cable.
- Roller fairlead.
- Winch Electrical Harness (715003777) is required for installation.
- Commander X m r front bumper requires Winch Electrical Harness (715008218).





|   |  |  |                 |
|---|--|--|-----------------|
| <b>WARN VRX 45-S Winch</b>  | Commander, Commander MAX, Maverick Trail, Maverick Sport, Maverick Sport MAX   | <b>715006111</b>   | <b>\$729.99</b> |
|  | <ul style="list-style-type: none"> <li>• Extreme IP68-rated waterproof sealing keeps the elements out.</li> <li>• Durable aluminum construction.</li> <li>• Black powder-coated finish and stainless steel fasteners for corrosion resistance.</li> <li>• Robust new clutch design based on 70+ years of WARN 4WD hub lock know-how.</li> <li>• Load-holding brake for great control.</li> <li>• Smooth and reliable aluminum three-stage planetary gear train.</li> </ul> | <ul style="list-style-type: none"> <li>• Dash-mounted rocker control.</li> <li>• Limited lifetime warranty (mechanical), 3-year warranty (electrical).</li> <li>• Pulling strength capability of 4,500 lb (2,041 kg).</li> <li>• 50' of 1" (15 m of 6.3 mm) synthetic rope.</li> <li>• Cast aluminum hawse fairlead.</li> <li>• Winch Electrical Harness (715003777) is required for installation.</li> <li>• Commander X m front bumper requires Winch Electrical Harness (715008218).</li> </ul> |                 |

## Winch Accessories

|   |   |                  |                |
|---|---|------------------|----------------|
| <b>Can-Am HD Hawse Fairlead</b>   | Can-Am HD Winch   | <b>715006426</b> | <b>\$57.99</b> |
|  | <ul style="list-style-type: none"> <li>• Must be used when upgrading your winch with a synthetic cable, this corrosion-proof aluminum hawse fairlead will prevent the cable from snapping in a corner of a roller fairlead and from wearing prematurely due to the rough surface of the worn roller guide.</li> <li>• Must be used with synthetic cables only.</li> </ul> |                  |                |

|   |  |                  |                |
|---|--|------------------|----------------|
| <b>WARN Hawse Fairlead</b>  | WARN Winch   | <b>705204567</b> | <b>\$97.99</b> |
|  | <ul style="list-style-type: none"> <li>• Double-powder-coated construction.</li> <li>• Required to use the Synthetic Winch Cable (715001118) on WARN winches.</li> <li>• To be used with synthetic winch cables only.</li> </ul> |                  |                |

|  |  |                  |
|--|--|------------------|
| <b>Roller Fairlead</b>   | Can-Am HD Winch  | <b>715007082</b> |
|  | <ul style="list-style-type: none"> <li>• Suggested when changing the wire rope.</li> <li>• Heavy-duty replacement fairlead for winches.</li> </ul> |                  |

|   |  |                  |                |
|---|--|------------------|----------------|
| <b>Wire Rope Replacement</b>  | Can-Am HD Winch  | <b>705014978</b> | <b>\$22.49</b> |
|  | <ul style="list-style-type: none"> <li>• 47' of 1" (14.3 m of 6.3 mm) wire rope.</li> <li>• 4,500 lb (2,041 kg) pulling strength.</li> </ul> |                  |                |

|   |  |                  |                 |
|---|--|------------------|-----------------|
| <b>Synthetic Winch Cable</b>  | Can-Am HD Winch  | <b>715006430</b> | <b>\$149.99</b> |
|  | <ul style="list-style-type: none"> <li>• 50' of 1" (15.2 m of 6.35 mm) synthetic cable for Can-Am HD winches.</li> <li>• Can-Am HD Hawse Fairlead (715006426) is required when upgrading to a synthetic cable to avoid premature cable damage and wear.</li> </ul> |                  |                 |

|   |   |                  |                 |
|---|---|------------------|-----------------|
| <b>Synthetic Winch Cable</b>  | WARN winch  | <b>715001118</b> | <b>\$144.99</b> |
|  | <ul style="list-style-type: none"> <li>• 50' of 1" (15.2 m of 6.35 mm) synthetic cable for WARN winch.</li> <li>• WARN Hawse Fairlead (705204567) is required when upgrading to a synthetic cable to avoid damage and premature wear of the cable.</li> </ul> |                  |                 |

|   |  |                  |                 |
|---|--|------------------|-----------------|
| <b>Synthetic Cable Extension</b>  | Commander, Commander MAX, Maverick Trail, Maverick Sport, Maverick Sport MAX   | <b>715001120</b> | <b>\$169.99</b> |
|  | <ul style="list-style-type: none"> <li>• Lightweight 1" (6.35 mm) diameter, easy to handle and won't rattle in cargo box.</li> <li>• Easily attaches to winch cable to provide additional 150' (15.2 m) of distance.</li> <li>• 4,500 lb (2,041 kg) single line capacity.</li> </ul> |                  |                 |

|                             |                 |                       |         |
|-----------------------------|-----------------|-----------------------|---------|
| <b>Wired Remote Control</b> | Can-Am HD Winch | 715006504 (2020 & up) | \$24.99 |
|-----------------------------|-----------------|-----------------------|---------|



- This kit allows winch owners to add the hand-held remote to vehicles with a stock winch.
- OEM stock winch and Wired Remote Control are sold separately.
- EC compliant.

|                                |            |           |          |
|--------------------------------|------------|-----------|----------|
| <b>Wireless Remote Control</b> | WARN Winch | 715002542 | \$214.99 |
|--------------------------------|------------|-----------|----------|



- The system is quick and easy to install, thanks to a wiring harness with an integrated antenna and all necessary mounting hardware.
- Allows you to operate your winch from anywhere within a 50' (15.2 m) radius, increasing your recovery options.
- All components are weatherproof.

## Hitches

|                             |  |           |          |
|-----------------------------|--|-----------|----------|
| <b>Front Receiver Hitch</b> | Commander, Commander MAX, Maverick Trail, Maverick Sport, Maverick Sport MAX | 715003642 | \$139.99 |
|-----------------------------|--|-----------|----------|



- Heavy-duty 1,500 lb (680 kg) towing capacity 2" (5 cm) receiver hitch.
- Perfect for precision towing in small spaces.

|                                     |                          |           |         |
|-------------------------------------|--------------------------|-----------|---------|
| <b>Front and Rear Hitch Drawbar</b> | Commander, Commander MAX | 715008350 | \$99.99 |
|-------------------------------------|--------------------------|-----------|---------|



- Standard on 2" (5 cm) receiver hitch.
- Offers 1,650 lb (750 kg) of towing capacity.
- Hitch ball not included.
- Forged steel.

# PERFORMANCE

## Smart-Lok Technology

|                               |   |           |            |
|-------------------------------|---|-----------|------------|
| <b>Smart-Lok Differential</b> | Maverick Trail, Maverick Sport, Maverick Sport MAX (2021 & prior) | 705402936 | \$1,679.99 |
|-------------------------------|---|-----------|------------|



- Can-Am exclusive Smart-Lok technology constitutes a true fully lockable on-the-fly front differential with electronically controlled automatic modes.
- Choose your differential settings according to your riding need: "2x4" for rear wheel traction only, "4x4 Front Diff Lock" for a fully locked 4 wheel drive, and "4x4 Smart Mode" that offers preset, intelligent calibrations for your type of riding.
- Using multiple input sources, "Smart Mode" will instantaneously engage locking with the right load at the right moment to procure maximum traction while retaining low-speed maneuverability, allowing for optimal placement and a feeling of confidence.
- The Smart-Lok Differential Kit comes standard with the Trail Mode.
- Mud, Rock and Trail Active modes can be added by installing an additional Smart Mode Module (sold separately) to fine-tune your riding environment.
- Requires Performance Half Shafts (2x) and Smart-Lok Installation Kit for installation.

|                               |                                    |           |          |
|-------------------------------|------------------------------------|-----------|----------|
| <b>Performance Half Shaft</b> | Maverick Trail                     | 705402423 | \$229.99 |
|                               | Maverick Sport, Maverick Sport MAX | 705402281 |          |



- High-performance design ideal for off-road use, with superior protection in any riding usage.
- Includes CVs, shaft and boots with the best suited geometry for your Can-Am vehicle.
- Required to install the Smart-Lok Differential Kit.

## Mud Smart Mode Module

(Not illustrated)

Models with Smart-Lok Differential

715005282

\$179.99

- This module allows you to add the Mud Smart Mode to vehicles with the Smart-Lok Differential. It is sold as an accessory or to change to the Mud Smart Mode on vehicles equipped with a standard Smart-Lok.
- The Mud Mode has been specially designed to deliver superior traction in the deepest mud holes.
- When high engine torque and/or slippage is detected, Smart-Lok will fully lock the front end.
- The system will stay locked until throttle release.
- Only one Smart Mode Module can be installed at a time.

## Rock Smart Mode Module

(Not illustrated)

Models with Smart-Lok Differential

715005283

\$179.99

- This module allows you to add the Rock Smart Mode to vehicles with the Smart-Lok Differential. It is sold as an accessory or to change to the Rock Smart Mode on vehicles equipped with a standard Smart-Lok.
- The Rock Mode has been specially designed to help cross challenging rocks.
- When high engine torque is detected at low vehicle speed, Smart-Lok will progressively lock the front end and will stay engaged until throttle release to prevent wheel slippage and provide optimal traction.
- The progressive engagement allows for easier steering when maneuvering the vehicle.
- Only one Smart Mode Module can be installed at a time.

## Trail Activ Smart Mode Module

(Not illustrated)

Models with Smart-Lok Differential

715005284

\$179.99

- This module allows you to add the Trail Activ Smart Mode to vehicles with the Smart-Lok Differential. It is sold as an accessory or to change to the Trail Activ Smart Mode on vehicles equipped with a standard Smart-Lok.
- The Trail Activ Mode has been designed for aggressive riding, delivering the ultimate cornering precision.
- When high engine torque and/or an increase in vehicle speed is detected, Smart-Lok will progressively engage the front end and keep it engaged until throttle release or vehicle speed reduction.
- The progressive engagement allows for smoother and lower steering effort.
- Only one Smart Mode Module can be installed at a time.

## Exhaust and Air Intake

### Yoshimura<sup>†</sup> Slip-On Exhaust



Maverick Sport, Maverick Sport M AX  
(Models with 1000R engine)

715004452

\$1,289.99

- Developed in collaboration with Yoshimura.
- Made from 304-grade stainless steel.
- Sporty sound from a lighter-than-stock muffler.
- USDF/USDA approved spark arrester.
- EPA compliant.
- Not EC compliant.

### Performance Air Filter by Twin AIR<sup>†</sup>



Commander, Commander M AX, Maverick Trail,  
Maverick Sport, Maverick Sport M AX (Models  
with 1000R engine)

715002895

\$109.99

Maverick Trail, Maverick Sport  
(except models with 1000R engine)

715003630

\$119.99

- The best choice for the harshest conditions.
- Multiple staged oiled filtering foam for superior dust retaining capacity with high airflow.
- Washable and reusable.

### Engine and CVT Pre-Filter Kit

(Not illustrated)

Commander, Commander M AX,  
Maverick Trail, Maverick Sport,  
Maverick Sport M AX

715004290

\$89.99

- Adds extra protection to your engine and CVT in harsh riding conditions.
- Filter blocks particles larger than 0.005" (0.1 mm).
- Water repellent screen.
- Mandatory to maintain the vehicle's warranty when tracks are installed.
- Recommended for winter riding conditions.
- Not compatible with Snorkel Kit.
- Not compatible with Adventure Roof Rack.

### Snorkel Pre-Filter



Commander, Commander M AX,  
Maverick Trail, Maverick Sport,  
Maverick Sport M AX

715005598

\$124.99

- Pre-filters specifically for snorkels.
- Adds extra protection to your engine in harsh riding conditions.
- Helps keep air filter cleaner.
- Filter blocks particles larger than 0.005" (0.13 mm).
- Mandatory to maintain vehicle warranty when tracks are installed.

|                    |   |                  |                 |
|--------------------|---|------------------|-----------------|
| <b>Snorkel Kit</b> | Com m ander,Com m anderM AX (except700 engines), M averick Trail (except700 engines), M averick Sport,M averick SportM AX | <b>715003705</b> | <b>\$559.99</b> |
|--------------------|---|------------------|-----------------|



- Raises point of engine and CVT air intakes so vehicle can be semi-submerged in water/mud without taking in water to the engine.
- Not compatible with S&B Particle Separator, LinQ Pivoting Rack, Lonestar Racing Rear Intusion Bar and all rear panels and windows.
- Standard on M averick Sport and Com m ander X m rm odel s.
- Not EC compliant.

|                              |                 |                  |                 |
|------------------------------|-----------------|------------------|-----------------|
| <b>Heavy-Duty Spring Kit</b> | M averick Trail | <b>715004961</b> | <b>\$369.99</b> |
|------------------------------|-----------------|------------------|-----------------|



- This set of heavy-duty springs will stiffen your suspension.
- Perfect for reducing vehicle overall sag when shocks are under heavy demand: heavy loading and hauling or for snow clearing.
- Complete kit of 4 springs.

|  |                                      |                  |                |
|--|--------------------------------------|------------------|----------------|
| <b>Shock Covers</b><br>(Not illustrated) | M averick Sport, M averick SportM AX | <b>715002368</b> | <b>\$41.99</b> |
|--|--------------------------------------|------------------|----------------|

- Soft covers for shocks with ventilation holes.
- Eliminate dust and dirt intrusion into the shock cylinder, reducing risk of damage.
- Sold in pairs.

## Emergency Accessories

|                      |  |                  |                 |
|----------------------|--|------------------|-----------------|
| <b>Emergency Kit</b> | Com m ander,Com m anderM AX, M averick Trail, M averick Sport, M averick SportM AX | <b>715006102</b> | <b>\$159.99</b> |
|----------------------|--|------------------|-----------------|



- Complete emergency kit provides all essential equipment and supplies to get out of most unfavorable situations power sport enthusiasts can find themselves in.
- Includes: Jumper Cables, Air Compressor, Tire Repair Kit, Ratchet Tie-Down, Duct Tape, Tow Strap 3,300 lb (1,500 kg), Zip Ties, Cloth Rags.

# APACHE TRACK SYSTEMS



## Winter Tracks

**Limited Warranty\***

|  |                               |                  |
|--|-------------------------------|------------------|
| <b>Apache Backcountry Track System</b> | See table for specific models | <b>715005247</b> |
|--|-------------------------------|------------------|



- Designed to deliver the best flotation level and deep-snow performance on the market.
- Contact patch is 23% bigger than the Apache 360 LT.
- Provides an impressive average ground clearance increase of 7" (18 cm), keeps the vehicle out of deep snow.
- Aggressive track design with 2" (5 cm) lug height for maximum traction on snow.
- Apache Backcountry Mounting Kit, Track DPS Module and Engine and CVT Pre-Filter are required.
- For winter use only.
- Track installation will affect vehicle width and length.

|   |                               |                  |
|---|-------------------------------|------------------|
| <b>Apache Backcountry LT Track System</b> | See table for specific models | <b>715005891</b> |
|---|-------------------------------|------------------|



- Tracks designed to deliver the best snow performance on the market with unmatched flotation level and traction on snow surface.
- Large contact patch, 37% bigger than the Apache 360 LT.
- Impressive added ground clearance of 7" (18 cm) helps keep the vehicle over the snow.
- Lightweight snowmobile-inspired rail design.
- Aggressive track design with 2" (5 cm) lug height for maximum traction on snow.
- Apache Backcountry LT Mounting Kit, Track DPS Module, Engine and CVT Pre-Filter are required.
- Fine-tune your track system using extra Kiler Wheels, Sliders with Vespel Inserts and Rail Ice Scratcher.
- For winter use only.
- Track installation will affect vehicle width and length.

\*The limited warranty is subject to the exclusions, limitations of liabilities and all other terms and conditions of BRP's standard limited warranty.



|  |                               |           |
|--|-------------------------------|-----------|
| <b>Apache Backcountry Mounting Kit</b><br><i>(Not illustrated)</i> | See table for specific models | 715004834 |
|  | Maverick Trail                | 715004285 |

- Required for installation of the Apache Backcountry Track System .
- Not compatible with HM W PE Front and Rear A-Am Protectors and Ski Plates .
- DPS Module and Pre-Filter not included .

|   |                               |           |
|---|-------------------------------|-----------|
| <b>Apache Backcountry LT Mounting Kit</b><br><i>(Not illustrated)</i> | See table for specific models | 715005493 |
|---|-------------------------------|-----------|

- Required for installation of the Apache Backcountry Track LT System .
- DPS Module and Pre-Filter are required and sold separately .
- Not compatible with HM W PE Front and Rear A-Am Protectors and Ski Plates .

## Accessories

|   |   |           |
|---|---|-----------|
| <b>Track DPS Module</b><br><i>(Not illustrated)</i> | Commander, Commander M AX 2021 & up, Maverick Trail, Maverick Sport | 715007338 |
|---|---|-----------|

- Innovative DPS module that ensures speedometer accuracy and optimized steering assist which make for perfect track control and riding ease .
- Required to install the Apache and Backcountry Track Systems .

|                            |  |           |
|----------------------------|--|-----------|
| <b>Rail Ice Scratchers</b> | Apache Backcountry and Apache Backcountry LT track systems | 860201728 |
|----------------------------|--|-----------|



- Provide additional lubrication in hard and icy conditions .
- Rail mounted, small, light .
- Design expands on coil concept to allow reversing without damage .
- Easily stored when not in use .
- Extend skidder life .

## Year-Round Tracks

Limited Warranty\*

|                                   |  |           |
|-----------------------------------|--|-----------|
| <b>Apache 360 LT Track System</b> | Commander, Commander M AX, Maverick Trail, Maverick Sport, Maverick Sport M AX | 715005103 |
|-----------------------------------|--|-----------|



- Multifunctional tracks designed to support heavy loads and to fit on most Can-Am off-road vehicles .
- Extra contact patch adjustment for better performance over rough terrain .
- Contact patch is 7 to 9% bigger than the Apache 360's .
- Average ground clearance of 16" (41 cm) . 1" (2.5 cm) lifts in the front and 1.25" (3.2 cm) in the back .
- EC compliant .
- Apache Backcountry LT Mounting Kit, Track DPS Module, Engine and CVT Pre-Filter are required .

|   |                               |           |
|---|-------------------------------|-----------|
| <b>Apache 360 LT Mounting Kit</b><br><i>(Not illustrated)</i> | See table for specific models | 715004755 |
|   | Maverick Trail                | 715004833 |

- Required for installation of the Apache 360 LT Track System .
- DPS Module and Pre-Filter not included .
- Not compatible with HM W PE Front and Rear A-Am Protectors and Ski Plates .

|   |                               |           |
|---|-------------------------------|-----------|
| <b>Apache 360 LT Mounting Kit</b><br><i>(Not illustrated)</i> | See table for specific models | 715005492 |
|---|-------------------------------|-----------|

- Required for installation of the Apache 360 LT Track System .
- DPS Module and Pre-Filter not included .
- Not compatible with HM W PE Front and Rear A-Am Protectors and Ski Plates .

\*The limited warranty is subject to the exclusions, limitations of liabilities and all other terms and conditions of BRP's standard limited warranty.

## Accessories

|                        |  |                            |
|------------------------|--|----------------------------|
| <b>Idler Wheel Kit</b> | Apache Backcountry Track System , rear tracks only | <b>860201230</b><br>141 mm |
|------------------------|--|----------------------------|



- Reduces drag and rolling resistance.
- Includes 2 wheels, brackets and hardware.
- Add up to 2 kits per rear track.
- Can extend slider life in hardened snow conditions.

|  |   |                  |
|--|---|------------------|
| <b>Apache Backcountry LT Wheel Kit</b> | Apache Backcountry and Apache Backcountry LT Track System s | <b>715006293</b> |
|--|---|------------------|



- Additional wheel kit for Backcountry LT rear tracks.
- Reduces drag and rolling resistance in hard snow conditions or when transporting heavier loads.
- Extends slider life in hard snow conditions.
- Includes two wheels, cross shaft and mounting hardware per kit to service one track corner.
- Up to two kits per rear track can be installed.

|                                     |   |                  |                 |
|-------------------------------------|---|------------------|-----------------|
| <b>Sliders with Vespel® Inserts</b> | Apache Backcountry and Apache Backcountry LT Track System s | <b>503194815</b> | <b>\$104.99</b> |
|-------------------------------------|---|------------------|-----------------|



- Use DuPont Vespel inserts for less friction.
- Longer life.
- Can be cut to desired length.
- 8 needed per vehicle.
- Sold individually.

## APACHE TRACK SYSTEMS FITTING GUIDE

### Apache Backcountry and Backcountry LT

| Model Year / Model   | Track   | Track Mount      | Track DPS Module | Pre Iter without Snorkel          | Pre Iter with Snorkel |
|--|---|------------------|------------------|-----------------------------------|-----------------------|
| 2018 & Up<br>Maverick Trail  | <b>715005247</b>  | <b>715004285</b> | <b>715007338</b> | <b>715004290</b><br>(except XM 1) | <b>715005598</b>      |
| 2021 & Up<br>Commander DPS & Commander XT 700 60"  | <b>715005247</b><br>(Backcountry)<br>(doesn't fit 64")    | <b>715004834</b> |                  |                                   |                       |
| 2019 & Up<br>Maverick Sport, Maverick Sport M AX<br>(except XM 1, X 1c, X xc models) 60" | <b>715005891</b><br>(Backcountry LT)<br>(doesn't fit 60") | <b>715005493</b> |                  |                                   |                       |
| 2021 & Up<br>Commander, Commander M AX<br>(except Commander DPS & Commander XT 700) 64"  |   |                  |                  |                                   |                       |
| 2019 & Up<br>Maverick Sport XM 1, X 1c, X xc 64"   |   |                  |                  |                                   |                       |

### Apache 360 LT

| Model Year / Model   | Track            | Track Mount      | Track DPS Module | Pre Iter without Snorkel | Pre Iter with Snorkel |
|--|------------------|------------------|------------------|--------------------------|-----------------------|
| 2018 & Up<br>Maverick Trail 50"  | <b>715005103</b> | <b>715004833</b> | <b>715007338</b> | <b>715004290</b>         | <b>715005598</b>      |
| 2021 & Up<br>Commander DPS & Commander XT 700 60"  |                  | <b>715004755</b> |                  |                          |                       |
| 2019 & Up<br>Maverick Sport, Maverick Sport M AX<br>(except XM 1, X 1c, X xc models) 60" |                  |                  |                  |                          |                       |
| 2021 & Up<br>Commander, Commander M AX (except<br>Commander DPS & Commander XT 700) 64"  |                  | <b>715005492</b> |                  |                          |                       |
| 2019 & Up<br>Maverick Sport XM 1, X 1c, X xc 64"   |                  |                  |                  |                          |                       |



## PROMOUNT FLOW KITS

### Reference Chart

|                | 66" Black Steel | 66" Yellow Steel | 72" Black Steel | 72" Yellow Steel | 66" Flex2 | 72" Flex2 |
|----------------|-----------------|------------------|-----------------|------------------|-----------|-----------|
| Plow Kit       | 715007775       | 715008174        | 715007777       | 715008173        | 715007774 | 715007776 |
| Blade          | 715006337       | 715006338        | 715004474       | 715006021        | 715006265 | 715004485 |
| Push Frame     | 715007752       | 715007752        | 715007752       | 715007752        | 715007752 | 715007752 |
| Mounting Plate | 715007742       | 715007742        | 715007742       | 715007742        | 715007742 | 715007742 |



### Can-Am ProMount Steel Plow Kits

|  |  |   |                   |
|--|--|---|-------------------|
| <b>Can-Am ProMount Steel 66" (168 cm) Plow Kit</b> | Commander, Commander M AX, Maverick Trail, Maverick Sport, Maverick Sport M AX | <ul style="list-style-type: none"> <li>■ 715007775 - Black</li> <li>■ 715008174 - Yellow</li> </ul> | <b>\$1,069.97</b> |
| <b>Can-Am ProMount Steel 72" (183 cm) Plow Kit</b> | Commander, Commander M AX, Maverick Trail, Maverick Sport, Maverick Sport M AX | <ul style="list-style-type: none"> <li>■ 715007777 - Black</li> <li>■ 715008173 - Yellow</li> </ul> | <b>\$1,139.97</b> |



- These kits include:
  - Can-Am ProMount Steel Blade
  - Push Frame with Quick-Attach System
  - Can-Am ProMount Mounting Plate

### Can-Am ProMount Steel Blades

|  |  |   |                 |
|--|--|---|-----------------|
| <b>Can-Am ProMount Steel 66" (168 cm) Blade</b>  | Fits ProMount Push Frame   | <ul style="list-style-type: none"> <li>■ 715006337 - Black</li> <li>■ 715006338 - Yellow</li> </ul> | <b>\$409.99</b> |
|  <ul style="list-style-type: none"> <li>• Plow blade made from 12-gauge steel.</li> <li>• Replaceable wearblade.</li> <li>• Large pin designed for easy blade rotation to eliminate snow buildup at pivot point.</li> <li>• Blade design provides best snow roll-off at any angle.</li> </ul> | <ul style="list-style-type: none"> <li>• Clears 60" (152 cm) when plow is fully angled.</li> <li>• Blade height of 17" (43 cm).</li> <li>• Compatible with Can-Am ProMount Blade accessories to further enhance plow versatility.</li> <li>• Not compatible with S3 High Clearance Front A-Arm.</li> </ul> |   |                 |
| <b>Can-Am ProMount Steel 72" (183 cm) Blade</b>  | Fits ProMount Push Frame   | <ul style="list-style-type: none"> <li>■ 715004474 - Black</li> <li>■ 715006021 - Yellow</li> </ul> | <b>\$479.99</b> |
|  <ul style="list-style-type: none"> <li>• Plow blade made from 12-gauge steel.</li> <li>• Replaceable wearblade.</li> <li>• Large pin designed for easy blade rotation to eliminate snow buildup at pivot point.</li> <li>• Blade design provides best snow roll-off at any angle.</li> </ul> | <ul style="list-style-type: none"> <li>• Clears 66" (168 cm) when plow is fully angled.</li> <li>• Blade height of 17" (43 cm).</li> <li>• Compatible with Can-Am ProMount Blade accessories to further enhance plow versatility.</li> <li>• Not compatible with S3 High Clearance Front A-Arm.</li> </ul> |   |                 |

## Can-Am ProMount Angle Plows

|  |                          |                  |                 |
|--|--------------------------|------------------|-----------------|
| <b>Can-Am ProMount 66" (168 cm) Steel Oneway State Blade</b> | Fits ProMount Push Frame | <b>715007263</b> | <b>\$489.99</b> |
| <b>Can-Am ProMount 72" (183 cm) Steel Oneway State Blade</b> | Fits ProMount Push Frame | <b>715007264</b> | <b>\$539.99</b> |



- Make the job easier with the right tools, clear long alleys and make the task easier by sending the snow further out of the way.
- Wing end of plow measures 26" (67 cm) high and tapers down to 16" (41 cm).
- One-way "winged" state plow designed to throw snow higher.
- Rubber Flap (715007299) designed to keep snow away from the driver is offered as accessory (sold separately).
- Can-Am branded.

## Can-Am ProMount Flex2 Plow Kit

|  |  |                  |                   |
|--|--|------------------|-------------------|
| <b>Can-Am ProMount Flex2 66" (168 cm) Plow Kit</b> | Commander, Commander M AX, Maverick Trail, Maverick Sport, Maverick Sport M AX | <b>715007774</b> | <b>\$1,169.97</b> |
| <b>Can-Am ProMount Flex2 72" (183 cm) Plow Kit</b> | Commander, Commander M AX, Maverick Trail, Maverick Sport, Maverick Sport M AX | <b>715007776</b> | <b>\$1,249.97</b> |



- These kits include:
  - Can-Am ProMount Flex2 Blade
  - Push Frame with Quick-Attach System
  - Can-Am ProMount Mounting Plate

## Can-Am ProMount Flex2 Blades

|   |                          |                  |                 |
|---|--------------------------|------------------|-----------------|
| <b>Can-Am ProMount Flex2 66" (168 cm) Blade</b> | Fits ProMount Push Frame | <b>715006265</b> | <b>\$509.99</b> |
| <b>Can-Am ProMount Flex2 72" (183 cm) Blade</b> | Fits ProMount Push Frame | <b>715004485</b> | <b>\$589.99</b> |



- Plow blade made of UHMWPE, flexible and in fact absorbing material prevents damaging your plow when accidental impact occurs.
- Replaceable wear blade.
- Large pin designed for easy blade rotation to eliminate snow buildup at pivot point.
- Blade design provides best snow roll-off at any angle.
- Carries 60" (152 cm) when plow is fully angled.
- Blade height of 17" (43 cm).
- Compatible with Can-Am ProMount Blade accessories to further enhance plow versatility.



- Plow blade made of UHMWPE, flexible and in fact absorbing material prevents damaging your plow when accidental impact occurs.
- Replaceable wear blade.
- Large pin designed for easy blade rotation to eliminate snow buildup at pivot point.
- Blade design provides best snow roll-off at any angle.
- Carries 66" (168 cm) when plow is fully angled.
- Blade height of 17" (43 cm).
- Compatible with Can-Am ProMount Blade accessories to further enhance plow versatility.

## Can-Am ProMount Plow Accessories

|                                     |  |                  |                |
|-------------------------------------|--|------------------|----------------|
| <b>Can-Am ProMount Edge Markers</b> | Commander, Commander M AX, Maverick Trail, Maverick Sport, Maverick Sport M AX | <b>715004206</b> | <b>\$45.99</b> |
|-------------------------------------|--|------------------|----------------|



- Help locate the edges of your plow.
- Height: 24" (60 cm).
- Sold in pairs.
- Recommended for Maverick Trail and Maverick Sport.
- Compatible with Can-Am ProMount Steel and Flex2 blades with or without Blade Extensions (except for the Can-Am ProMount Steel 154" (137 cm) Blades).



|  |  |                  |                 |
|--|--|------------------|-----------------|
| <b>Can-Am ProMount 66" (168 cm) Plastic Wear Blade</b> | Maverick Trail, Maverick Sport, Maverick SportM AX                           | <b>715004482</b> | <b>\$179.99</b> |
| <b>Can-Am ProMount 72" (183 cm) Plastic Wear Blade</b> | Commander, CommanderM AX, Maverick Trail, Maverick Sport, Maverick SportM AX | <b>715004483</b> | <b>\$199.99</b> |



- Helps prevent leaving marks on your driveway.
- Compatible with Can-Am ProMount 72" (183 cm) Blades.

|                                      |  |                  |                 |
|--------------------------------------|--|------------------|-----------------|
| <b>Can-Am ProMount Drift Cutters</b> | Commander, CommanderM AX, Maverick Trail, Maverick Sport, Maverick SportM AX | <b>715006258</b> | <b>\$159.99</b> |
|--------------------------------------|--|------------------|-----------------|



- Help keep snow in the plow.
- Dimensions: 17" x 13" (43.2 cm x 33 cm).
- Sold in pairs.
- Compatible with Can-Am ProMount Steel and Flex2 blades with or without Blade Extensions (except for the Can-Am ProMount Steel 54" (137 cm) Blades).

|   |  |   |                 |
|---|--|---|-----------------|
| <b>Can-Am ProMount Blade Extensions</b> | Commander, CommanderM AX, Maverick Trail, Maverick Sport, Maverick SportM AX | <b>715004205</b> - Black<br><b>715005319</b> - Yellow | <b>\$119.99</b> |
|---|--|---|-----------------|



- These conveniently extend your Can-Am ProMount Blade.
- Add 3" (8 cm) each side.
- Compatible with Can-Am ProMount Blades (except for the Can-Am ProMount Steel 54" (137 cm) Blades).
- Longer Wear Blade can be installed to go over the extra length given by the extensions.

|  |                               |                  |                 |
|--|-------------------------------|------------------|-----------------|
| <b>Back Drag Blade</b><br><i>(Not illustrated)</i> | ProMount Plows (60" and more) | <b>715007794</b> | <b>\$279.99</b> |
|--|-------------------------------|------------------|-----------------|

- 1/4" thick steel swivel scraper.
- Lifts up when the vehicle is moving forward so as to not affect the scraping.
- Increased capacity to pull snow.
- More aggressive scraping in reverse mode.
- Lifts the scraper off the ground so that it scrapes evenly.
- Adjustable in length for compatibility with 60", 66" and 72" blades.
- Compatible with ProMount blades (Flex and Steel).

|  |  |  |                 |
|--|--|--|-----------------|
| <b>Curved Wear Blade</b><br><i>(Not illustrated)</i> | Commander, CommanderM AX, Maverick Trail, Maverick Sport, Maverick SportM AX | <b>715007792</b> - 66" (168 cm)<br><b>715007793</b> - 72" (183 cm) | <b>\$114.99</b> |
|--|--|--|-----------------|

- Wear blade designed with a folded back bottom lip.
- The increased surface allows for less digging while plowing uneven surfaces.
- Ideal for snow covered gravel, grass, paver stone and other soft surfaces.

## Can-Am Promount Custom Solutions

|  |  |                  |                 |
|--|--|------------------|-----------------|
| <b>Can-Am ProMount Push Frame with Quick-Attach System</b> | Commander, CommanderM AX, Maverick Trail, Maverick Sport, Maverick SportM AX | <b>715007752</b> | <b>\$499.99</b> |
|--|--|------------------|-----------------|



- Heavy-duty steel tubes designed to withstand the roughest use.
- Minimum mount carriage provides ultimate push strength and traction.
- Allows 16" (41 cm) of plow lift on ATVs and 14" (36 cm) on Maverick Trail.
- Features a self-aligning quick-attach system, an easy foot release pedal and an ergonomic handle for plow angle adjustment.

|   |  |                  |                 |
|---|--|------------------|-----------------|
| <b>Can-Am ProMount Push Frame Extension</b> | Commander, CommanderM AX, Maverick Trail, Maverick Sport, Maverick SportM AX | <b>715006257</b> | <b>\$174.99</b> |
|---|--|------------------|-----------------|



- 12" (30 cm) push frame extension required when plow is installed with Apache Track systems.

|                             |  |   |                |
|-----------------------------|--|---|----------------|
| <b>Plow Roller Fairlead</b> | Commander, CommanderM AX, Maverick Trail, Maverick Sport, Maverick SportM AX | <b>715001223</b><br>• Cylindrical Roller Fairlead | <b>\$81.99</b> |
|-----------------------------|--|---|----------------|



- Larger diameter roller reduces wear on wire rope for plow application.
- Can be used with all ProMount plows.

|  |  |                  |                 |
|--|--|------------------|-----------------|
| <b>Can-Am ProMount Plow Angling System</b> | Commander, CommanderM AX, Maverick Trail, Maverick Sport, Maverick SportM AX | <b>715007801</b> | <b>\$799.99</b> |
|--|--|------------------|-----------------|



- Converts your plow system into an easy-to-control unit from the driver's seat.
- Using one hand to control all plow motions will allow you to easily concentrate and manage your plowing tasks.
- Not compatible with Apache Backcountry LT Track System.
- Can-Am ProMount Push Frame (715007752) is required.
- Push Frame Extension (715006257) is required for installation with the Front Rancher Bumper.
- Winch and plow sold separately.

|   |  |                  |                 |
|---|--|------------------|-----------------|
| <b>ProMount Plow Limit Switch</b><br><i>(Not illustrated)</i> | Commander, CommanderM AX, Maverick Trail, Maverick Sport, Maverick SportM AX | <b>715006259</b> | <b>\$134.99</b> |
|---|--|------------------|-----------------|

- For controlling the cable tension when over-raising your plow system.
- Prevents winch, plow push frame and vehicle damage.
- Sensor relocated for optimal lift height.

|                                       |  |                  |                 |
|---------------------------------------|--|------------------|-----------------|
| <b>Can-Am ProMount Mounting Plate</b> | Commander, CommanderM AX, Maverick Trail, Maverick Sport, Maverick SportM AX | <b>715007742</b> | <b>\$159.99</b> |
|---------------------------------------|--|------------------|-----------------|



- Required to install the Can-Am ProMount Push Frame with Quick-Attach System.
- Mounting plate precision-designed to stay on year-round without compromising ground clearance.
- Plow Roller Fairlead included.

# COVERS



|                      |                                |                  |                 |
|----------------------|--------------------------------|------------------|-----------------|
| <b>Trailer Cover</b> | Commander                      | <b>715006817</b> | <b>\$419.99</b> |
|                      | CommanderM AX                  | <b>715007108</b> | <b>\$519.99</b> |
|                      | Maverick Trail, Maverick Sport | <b>715003706</b> | <b>\$409.99</b> |



- Weather-resistant trailer cover protects your vehicle during storage and transportation.
- Heavy-duty canvas made of UV-resistant solution-dyed polyester.
- Inner soft liner protects windshield.
- All high-abrasion areas are reinforced with a double canvas layer.
- Opening for fuel cap.
- Quick and easy installation.
- Designed to perfectly fit your vehicle with or without Can-Am accessories except with Adventure Roof Rack and track kits.





---

# PARTS AND MAINTENANCE

---



---

# PARTS AND MAINTENANCE

---

|                              |     |
|------------------------------|-----|
| Keep an Eye on These Parts   | 220 |
| Genuine Parts                | 224 |
| XPS Tires                    | 228 |
| Tires & Rims                 | 229 |
| Lubricant & Oil Change Kit   | 234 |
| Maintenance Products         | 235 |
| How to Use XPS Care Products | 236 |
| Care Products                | 237 |

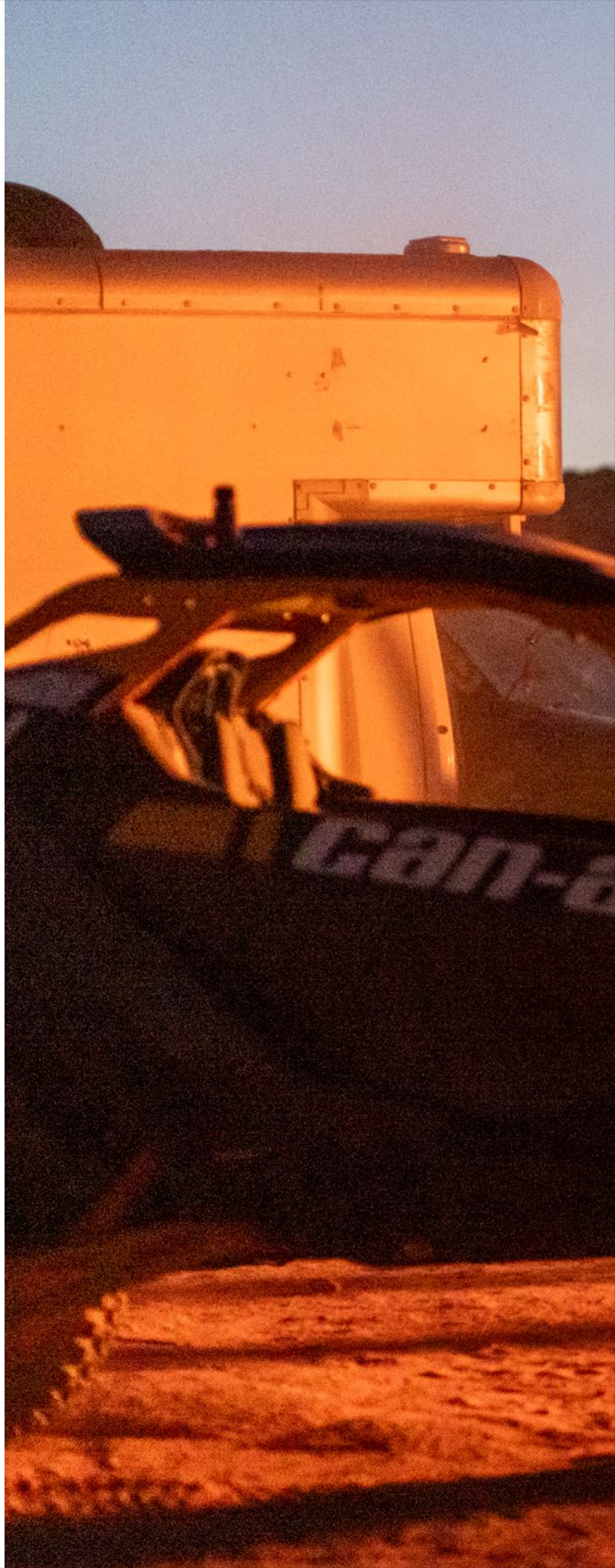



# BLENDING PERFORMANCE AND SAFETY

Trust genuine Can-Am  
parts to keep your vehicle  
performing at its best.

---

## ONE YEAR WARRANTY

---

Precisely engineered. Rigorously tested. Factory approved.

\*Covers parts and labor when fitted at an authorized dealer.





To make sure your Defender performs as you expect, **keep an eye on these components:\*\***

## **OIL FILTER** 420256188

### **ENGINE OIL**

|                                     |         |
|-------------------------------------|---------|
| <b>4T 10W-50 Synthetic Oil</b>      |         |
| 1 quart / 946 mL                    | 9779234 |
| 1 US gallon / 3.785 L               | 9779235 |
| <b>4T 0W-40 Synthetic Oil</b>       |         |
| 1 quart / 946 mL                    | 9779139 |
| 1 US gallon / 3.785 L               | 9779140 |
| <b>4T 5W-40 Synthetic Blend Oil</b> |         |
| 1 quart / 946 mL                    | 9779133 |
| 1 US gallon / 3.785 L               | 9779134 |

### **OIL CHANGE KIT**

|                                  |         |
|----------------------------------|---------|
| <b>5W-40 Synthetic Blend Oil</b> |         |
| 500 cc or more V-twin engine     | 9779258 |
| <b>0W-40 Synthetic Oil</b>       |         |
| 500 cc or more V-twin engine     | 9779259 |
| <b>10W-50 Synthetic Oil</b>      |         |
| 500 cc or more V-twin engine     | 9779252 |
| <b>5W-40 Synthetic Blend Oil</b> |         |
| 450 cc or less                   | 9779256 |
| <b>0W-40 Synthetic Oil</b>       |         |
| 450 cc or less                   | 9779257 |

### **FUEL FILTER**

|                 |           |
|-----------------|-----------|
| Non-EVAP models | 709001120 |
| EVAP models     | 513034047 |

## **AIR FILTER** 715900394

### **CVT AIR FILTER**

|                  |           |
|------------------|-----------|
| <b>HD9, HD10</b> | 420450400 |
|------------------|-----------|

### **DRIVE BELT**

|                             |           |
|-----------------------------|-----------|
| <b>HD10 Premium (Stock)</b> | 422280652 |
| <b>HD9 Premium (Stock)</b>  | 422280656 |
| <b>HD7 Premium (Stock)</b>  | 422280225 |

**Performance (Upgrade):**  
see Reference Chart for upgrade

### **METALLIC BRAKE PADS**

|                               |           |
|-------------------------------|-----------|
| <b>Defender, Defender Max</b> |           |
| Front Left                    | 715900379 |
| Front Right                   | 715900380 |
| <b>Defender HD8, HD10</b>     |           |
| Rear Left                     | 715900381 |
| Rear Right                    | 715900382 |
| <b>Defender HD5</b>           |           |
| Rear Right                    | 715900387 |
| <b>Defender MAX HD8, HD10</b> |           |
| Rear Left                     | 715900386 |
| Rear Right                    | 715900387 |

## **CV BOOT KITS**

|                         |           |
|-------------------------|-----------|
| Front Wheel Side        | 705401345 |
| Front Differential Side | 705401355 |
| Rear                    | 705501864 |

## **WHEEL BEARINGS** 293350150

|                                |           |
|--------------------------------|-----------|
| <b>FRONT A ARM BUSHING KIT</b> | 703500875 |
|--------------------------------|-----------|

## **BALL JOINTS**

|       |           |
|-------|-----------|
| Upper | 706202044 |
| Lower | 706202045 |

## **SPARK PLUG**

|             |           |
|-------------|-----------|
| <b>HD10</b> | 715900244 |
| <b>HD9</b>  | 715900642 |
| <b>HD7</b>  | 715900785 |
| <b>HD5</b>  | 715900352 |

## **BATTERY**

|                        |           |
|------------------------|-----------|
| 18 Amps Wet (TX20L-BS) | 296000444 |
|------------------------|-----------|

\*\*Refer to periodic maintenance chart for proper intervals.

# CAN-AM MAVERICK SPORT, MAVERICK TRAIL AND COMMANDER



To make sure your **Maverick Sport, Trail or Commander** performs as you expect, **keep an eye on these components\*\***:

## **OIL FILTER** 420256188

### **ENGINE OIL**

#### **4T 10W-50 Synthetic Oil**

1 quart / 946 ml 9779234  
1 US galbn / 3.785 L 9779235

#### **4T 0W-40 Synthetic Oil**

1 quart / 946 ml 9779139  
1 US galbn / 3.785 L 9779140

#### **4T 5W-40 Synthetic Blend Oil**

1 quart / 946 ml 9779133  
1 US galbn / 3.785 L 9779134

### **OIL CHANGE KIT**

#### **5W-40 Synthetic Blend Oil**

500 cc or more V-twin engine 9779258

#### **0W-40 Synthetic Oil**

500 cc or more V-twin engine 9779259

#### **10W-50 Synthetic Oil**

500 cc or more V-twin engine 9779252

### **FUEL FILTER**

Non-EVAP models 709001120

EVAP models 513034047

## **AIR FILTER**

### **Performance Air Filter**

by Twin Air 715002895

### **Maverick Trail & Sport**

(700 cc & 1000 cc) 715900394

### **Maverick Trail & Sport**

(1000R) 715900422

### **Commander**

(700 cc & 1000 cc) 715900394

### **Commander 1000R**

715900422

## **CVT AIR FILTER**

Except X mr 706600417

## **DRIVE BELT**

**Maverick Trail 700** 422280225

**Maverick Trail / Sport 1000** 422280656

**Commander 700** 422280225

**Commander 2021+ 1000 cc** 422280656

### **Performance (Upgrade):**

see Reference Chart for upgrade

## **METALLIC BRAKE PADS**

Front Left 715900379

Rear Left 715900386

Front Right 715900380

Rear Right 715900387

## **CV BOOT KITS**

### **Maverick Sport, Commander (ABS, X xc, X mr, X rc models only)**

Front Wheel Side 705401354

### **Maverick Sport (no ABS),**

#### **Maverick Trail**

Front Wheel Side 705401345

Front Differential Side 705401355

Rear 705501864

## **WHEEL BEARINGS**

293350150

## **A ARM BUSHING KIT**

703500875

## **BALL JOINTS**

Upper 706203084

Lower 706202045

## **SPARK PLUG**

715900637

### **Maverick Trail 700**

715900785

**Maverick Trail & Sport 1000** 715900642

**Maverick Trail & Sport 1000R** 715900244

**Commander 700** 715900785

**Commander 1000R** 715900244

## **BATTERY**

18 Amps Wet (TX20LBS) 296000444

30 AH Battery Upgrade 515176151

\*\*Refer to periodic maintenance chart for proper intervals.



# CAN-AM MAVERICK X3



To make sure your Maverick X3 performs as you expect,  
**keep an eye on these components:\*\***

## **OIL FILTER** 420956123

### **ENGINE OIL**

#### **4T 10W-50 Synthetic Oil**

1 quart / 946 ml 9779234  
 1 US gallon / 3.785 L 9779235

#### **4T 0W-40 Synthetic Oil**

1 quart / 946 ml 9779139  
 1 US gallon / 3.785 L 9779140

#### **4t 5w-40 Synthetic Blend Oil**

1 quart / 946 ml 9779133  
 1 US gallon / 3.785 L 9779134

### **OIL CHANGE KIT**

#### **5W-40 Synthetic Blend Oil**

900 ACE 9779260

#### **10W-50 Synthetic Oil**

900 ACE 9779261

### **FUEL FILTER**

Non-EVAP models 709001120

EVAP models 513034047

## **AIR FILTER**

### **Performance Air Filter**

by Twin Air 715002895

### **Premium Air Filter**

715900422

### **CVT AIR FILTER**

420450405

## **DRIVE BELT**

422280652

## **METALLIC BRAKE PADS**

FrontLeft 715900379

RearLeft 715900386

FrontRight 715900380

RearRight 715900387

## **CV BOOT KITS**

Rear Wheel & Differential Side 715900450

Front Wheel & Differential Side 705401354

## **WHEEL BEARINGS**

293350151

## **BALL JOINTS**

Upper 706203084

Lower 706202045

## **SPARK PLUG**

415130363

## **BATTERY**

18 Amps Wet (TX20LBS) 296000444

\*\*Refer to periodic maintenance chart for proper intervals.





To make sure your **Maverick R** performs as you expect, **keep an eye on these components:\*\***

**OIL FILTER** 420956747

**ENGINE OIL**

**4T 10W-50 Synthetic Oil**

1 quart / 946 ml 9779234  
1 US gallon / 3.785 L 9779235

**4T 0W-40 Synthetic Oil**

1 quart / 946 ml 9779139  
1 US gallon / 3.785 L 9779140

**4t 5w-40 Synthetic Blend Oil**

1 quart / 946 ml 9779133  
1 US gallon / 3.785 L 9779134

**DCT OIL**

1 quart / 946 ml 9779710

**FUEL FILTER**

Non-EVAP models 709001120  
EVAP models 709000529

**AIR FILTER**

**Performance Air Filter**

by Twin Air 715002895

**Premium Air Filter**

715900422

**METALLIC BRAKE PADS**

Front 705601795

Rear 705601797

**CV BOOT KITS**

Rear Wheel & Differential Side 715900929

Front Wheel & Differential Side 715900450

**WHEEL BEARINGS**

Front 705402652

Rear 705503036

**BALL JOINTS**

Upper 706203084

Lower 706202045

**SPARK PLUG**

715900935

**BATTERY**

18 Amps Wet (TX20L-BS) 296000444

\*\*Refer to periodic maintenance chart for proper intervals.

# GENUINE PARTS

## Oil Filters

| Oil Filters   | Models                            | Oil Filter  |         | Sealing Ring (Oil Filter Cover) |        | Sealing Ring (Drain Plug) |        |
|---|-----------------------------------|-------------|---------|---------------------------------|--------|---------------------------|--------|
|   |                                   | Part Number | Price   | Part Number                     | Price  | Part Number               | Price  |
|  | Defender/DefenderM AX HD 10, HD 9 | 420256188   | \$12.99 | 420230923                       | \$2.99 | 420552280                 | \$3.49 |
|   | Defender/DefenderM AX HD 7        | 420256188   | \$12.99 | 420230922                       | \$0.87 | 420552280                 | \$3.49 |
|   | Maverick X3                       | 420956123   | \$12.99 | 420230923                       | \$2.99 | 420552280                 | \$3.49 |
|   | Maverick R                        | 420956747   | \$19.99 | 420230922                       | \$0.87 | 420552280                 | \$3.49 |
|   | Maverick Trail & Sport            | 420256188   | \$12.99 | 420230923                       | \$2.99 | 420552280                 | \$3.49 |
|   | Commander                         | 420256188   | \$12.99 | 420230922                       | \$0.87 | 420552280                 | \$3.49 |

Complete Engine Oil Change Kit also available – see page 234

## Air Filters

| Premium Air Filter | <ul style="list-style-type: none"> <li>• Premium quality filter.</li> <li>• Prevents airborne contaminants from reaching your engine.</li> <li>• Protects internal components against premature wear.</li> </ul> |
|--------------------|--|
|--------------------|--|

|  | Models                                      | Part Number | Price   |
|--|---|-------------|---------|
|  | Defender/DefenderM AX                       | 715900394   | \$45.99 |
|  | Maverick X3, Maverick R                     | 715900422   | \$44.99 |
|  | Maverick Trail & Sport (Engines 700 & 1000) | 715900394   | \$45.99 |
|  | Maverick Trail & Sport (Engine 1000R)       | 715900422   | \$44.99 |
|  | Commander (Engines 700 & 1000R)             | 715900394   | \$45.99 |
|  | Commander (Engine 1000R)                    | 715900422   | \$44.99 |

| Performance Air Filter by Twin Air <sup>†</sup> | <ul style="list-style-type: none"> <li>• The best choice for the harshest conditions.</li> <li>• Multiple staged oiled filtering foam for superior dust retaining capacity with high air flow.</li> <li>• Washable and reusable.</li> </ul> |
|---|---|
|---|---|

|  | Models                  | Part Number | Price    |
|---|-------------------------|-------------|----------|
|   | Maverick X3, Maverick R | 715002895   | \$109.99 |
|   | Maverick Trail & Sport  | 715002895   | \$109.99 |

| CVT Air Filter<br>(Not illustrated)   | Models    | Part Number | Price |
|---------------------------------------|-----------|-------------|-------|
| Defender/DefenderM AX (except X m r)  | 706600419 | \$18.49     |       |
| Maverick X3                           | 706600416 | \$58.99     |       |
| Maverick Trail & Sport (except X m r) | 706600417 | \$40.99     |       |
| Maverick Trail & Sport X m r          | 706600418 | \$38.99     |       |
| Commander (2018 & Up)                 | 706600417 | \$40.99     |       |

## Spark Plug

| Spark Plug  | Models                               |           |         |
|---|--------------------------------------|-----------|---------|
|  | DefenderHD 10                        | 715900244 | \$12.99 |
|   | DefenderHD 9                         | 715900642 | \$5.69  |
|   | DefenderHD 7                         | 715900785 | \$19.99 |
|   | Maverick X3 and Maverick X3 Turbo RR | 415130363 | \$19.99 |
|   | Maverick R                           | 715900935 | —       |
|   | Maverick Trail& Sport1000R           | 715900244 | \$12.99 |
|   | Maverick Trail& Sport1000            | 715900642 | \$5.69  |
|   | Maverick Trail700                    | 715900785 | \$19.99 |
|   | Commander700                         | 715900785 | \$19.99 |
|   | Commander1000R                       | 715900244 | \$12.99 |

## Batteries

| Yuasa <sup>1</sup> Batteries | · Top of the line models from the leading preferred original equipment battery supplier in North America. |          |   |          |
|------------------------------|---|----------|---|----------|
| Models                       | 18 A Wet (YTX20L-BS)  |          | 30 A, Requires Battery Holder (715004431)   |          |
| Defender/DefenderM AX        | 296000444   | \$159.99 | 515176151<br>Except Base<br>and DPS models. | \$209.99 |
| Maverick X3, Maverick R      | 296000444   | \$159.99 | —   | —        |
| Maverick Trail& Sport        | 296000444   | \$159.99 | —   | —        |
| Commander                    | 296000444   | \$159.99 | —   | —        |

## Axles

| Premium CV Axles          | · Premium quality design ideal for offroad, heavy-duty and low speed torque usage.<br>· Includes CVs, shaft and boots with the best suited geometry for your Can-Am vehicle. |          |             |          |           |          |
|---------------------------|--|----------|-------------|----------|-----------|----------|
| Models                    | Front Left   |          | Front Right |          | Rear      |          |
| DefenderM AX              | 705401937  | \$229.99 | 705401936   | \$229.99 | 705502451 | \$229.99 |
| DefenderXTP               | 705402353  | \$229.99 | 705402353   | \$229.99 | 705502451 | \$229.99 |
| DefenderHD 10             | 705401937  | \$229.99 | 705401936   | \$229.99 | 705502451 | \$229.99 |
| DefenderHD 9              | 705401937  | \$229.99 | 705401936   | \$229.99 | 705502451 | \$229.99 |
| DefenderHD 7              | 705402749  | \$229.99 | 705402750   | \$229.99 | 705503100 | \$229.99 |
| Maverick R                | 705402490  | \$269.99 | 705402490   | \$269.99 | 705502907 | \$264.99 |
| Maverick Sport (ABS)      | 705402443  | \$229.99 | 705402443   | \$229.99 | 705502756 | \$229.99 |
| Maverick Sport Base, DPS  | 705402031  | \$229.99 | 705402030   | \$229.99 | 705502552 | \$229.99 |
| Maverick Trail (W /O ABS) | 705402008  | \$229.99 | 705402007   | \$229.99 | 705502541 | \$229.99 |
| Maverick Trail (ABS)      | 705402442  | \$229.99 | 705402442   | \$229.99 | 705502755 | \$229.99 |
| Commander                 | 705401871  | \$229.99 | 705401872   | \$229.99 | 705502411 | \$229.99 |

## Performance CV Axles

(Not illustrated)

- High-performance design ideal for offroad use with superior wheel power and acceleration for racing, dunes, trails and desert riding.
- Includes CVs, shaft and boots with the best suited geometry for your Can-Am vehicle.

| Models                | Front Left |          | Front Right |          | Rear      |          |
|-----------------------|------------|----------|-------------|----------|-----------|----------|
| DefenderXmr           | 705402420  | \$259.99 | 705402420   | \$259.99 | —         | —        |
| Maverick SportXmr/Xrc | 705402282  | \$229.99 | 705402282   | \$229.99 | 705502757 | \$229.99 |

## Brakes

### Metallic Brake Pad Kit



- Built strong to last long - heavy-duty construction stands up to hard braking.
- Designed to handle demanding riding conditions with challenging braking environments such as mud and dunes.
- Created specifically for use with Can-Am vehicles.

| Models                 | Front Left |         | Front Right |         | Rear Left |         | Rear Right |         |
|------------------------|------------|---------|-------------|---------|-----------|---------|------------|---------|
| DefenderMAX HD 9/HD 10 | 715900379  | \$71.99 | 715900380   | \$71.99 | 715900386 | \$71.99 | 715900387  | \$71.99 |
| DefenderHD 10          | 715900379  | \$71.99 | 715900380   | \$71.99 | 715900381 | \$78.99 | 715900382  | \$71.99 |
| DefenderHD 9           | 715900379  | \$71.99 | 715900380   | \$71.99 | 715900381 | \$78.99 | 715900382  | \$71.99 |
| DefenderHD 7           | 715900379  | \$71.99 | 715900380   | \$71.99 | -         | -       | 715900387  | \$71.99 |
| Maverick X3            | 715900379  | \$71.99 | 715900380   | \$71.99 | 715900386 | \$71.99 | 715900387  | \$71.99 |
| Maverick R             | 705601795  | -       | 705601795   | -       | 705601797 | -       | 705601797  | -       |
| Maverick Trail & Sport | 715900379  | \$71.99 | 715900380   | \$71.99 | 715900386 | \$71.99 | 715900387  | \$71.99 |
| Commander              | 715900379  | \$71.99 | 715900380   | \$71.99 | 715900386 | \$71.99 | 715900387  | \$71.99 |

Please contact your dealer or visit our online store at [Can-Amoffroad.com](http://Can-Amoffroad.com) for suggested fitment.

## Parts

### A-Arm Bushing Kit

703500875

\$15.49



- This bushing kit includes 2 bushings, a sleeve and a wear plate, as illustrated.
- All you need to renew your suspension A-Arms.

### Ball Joints

Upper

706202044

\$36.99

Upper Maverick X3, Maverick R,  
Trail & Sport, Commander

706203084

\$39.99

Lower

706202045

\$44.99

- Robust design for off-road usage and sealed for prolonged durability.



### Wheel Bearings

(Not illustrated)

2020 models and prior

293350118

\$49.99

2021 & up models

293350126

\$45.99

Maverick X3

293350151

\$66.99

Maverick R

705402652 - Front

705503036 - Rear

\$119.99

- Sealed bearings for additional protection from water and dirt.



## CV Boot Kit

- Comes with clamps and grease.
- Genuine BRP CV Boot Kits ensure absolute compatibility and a perfect fit.



| Models                                   | Front Wheel Side |         | Front Differential Side |         | Rear Wheel & Differential Side |         |
|--|------------------|---------|-------------------------|---------|--------------------------------|---------|
|  | Part No.         | Price   | Part No.                | Price   | Part No.                       | Price   |
| Defender                                 | 705401345        | \$39.99 | 705401355               | \$39.99 | 705501864                      | \$39.99 |
| Maverick X3                              | 705401354        | \$39.99 | 705401354               | \$39.99 | 715900450                      | \$39.99 |
| Maverick R                               | 715900450        | \$39.99 | 715900450               | \$39.99 | 715900929                      | –       |
| Maverick Sport (ABS, X xc, X m r, X xc)  | 705401354        | \$39.99 | 705401355               | \$39.99 | 705501864                      | \$39.99 |
| Maverick Sport (w/o ABS), Maverick Trail | 705401345        | \$39.99 | 705401355               | \$39.99 | 705501864                      | \$39.99 |
| X m r                                    | 705401354        | \$39.99 | 705401355               | \$39.99 | 705501864                      | \$39.99 |
| Com m ander                              | 705401345        | \$39.99 | 705401355               | \$39.99 | 705501864                      | \$39.99 |

## Belts

### BRP Premium Drive Belt

- High-performance design ideal for off-road use.
- BRP-specific calibration adjusted to best suit your Can-Am vehicle.



| Models                               | Premium Belt |          | CVT Gasket Cover |         | Upgrades  |          |
|--------------------------------------|--------------|----------|------------------|---------|-----------|----------|
|                                      | Part No.     | Price    | Part No.         | Price   | Part No.  | Price    |
| Defender HD 10                       | 422280652    | \$229.99 | 420450400        | \$5.09  | –         | –        |
| Defender HD 9                        | 422280656    | \$169.99 | 420450400        | \$5.09  | 422280652 | \$229.99 |
| Defender HD 7                        | 422280225    | \$144.99 | –                | –       | –         | –        |
| Maverick X3                          | 422280652    | \$229.99 | 420450405        | \$29.99 | –         | –        |
| Maverick Trail & Maverick Sport 1000 | 422280656    | \$169.99 | 420450400        | \$5.09  | 422280652 | \$229.99 |
| Maverick Trail 700                   | 422280225    | \$144.99 | –                | –       | –         | –        |
| Com m ander 2020 & prior             | 422280366    | \$169.99 | 420450126        | –       | –         | –        |
| Com m ander 2021 & Up 1000 CC        | 422280656    | \$169.99 | 420450400        | \$5.09  | 422280652 | \$229.99 |
| Com m ander 700                      | 422280225    | \$144.99 | –                | –       | –         | –        |

### Driven Pulley Adapter Tool

(Not illustrated)

- Spreads the secondary clutch open for easy belt replacement.

### Clutch Spreader Tool

(Not illustrated)

- Allows you to spread the secondary clutch open for easy belt replacement.

| Models                 | Driven Pulley Adapter |         | Spreader Tool |         |
|------------------------|-----------------------|---------|---------------|---------|
|                        | Part No.              | Price   | Part No.      | Price   |
| Defender HD 10-HD 9    | 708200720             | \$25.99 | 529000088     | \$16.99 |
| Defender HD 7          | –                     | –       | 529036098     | \$19.49 |
| Maverick Trail & Sport | 708200720             | \$25.99 | 529000088     | \$16.99 |
| Maverick X3            | 708200720             | \$25.99 | 529000088     | \$16.99 |
| Com m ander            | –                     | –       | 529036352     | \$32.99 |

## pDrive Pulley Service Kits

### Ramp Roller Maintenance Set

All SxS pDrive

420629237

\$124.99

pDrive Ramp Roller Set



### Torque Roller Maintenance Set

All SxS pDrive

420629224

\$159.99

pDrive Torque Roller Set



# XPSTIRES

## SHOP BY USAGE



GRAVEL &  
HARD PACK



ROCK



MUD

### XPS Trail Force



- All-terrain radial tire.
- 8-ply rated construction.
- Versatile and suitable for many types of terrain.
- Aggressive tread pattern for better traction on dirt, mud and rocky terrains.
- Tread depth: 20 mm (0.78").

|                      |          |
|----------------------|----------|
| 705402754 - 27X9R14  | \$134.99 |
| 705503103 - 27X11R14 | \$144.99 |
| 705403026 - 26X8R14  | \$159.99 |
| 705503322 - 26X10R14 | \$179.99 |

### XPS Trail King



- All-terrain radial tire.
- 8-ply rated construction.
- Aggressive tread pattern for tough terrains.
- An almost continuous center tread offers a smooth trail ride.
- Tread depth: 26 mm (1.02").

|                      |          |
|----------------------|----------|
| 705402825 - 28X9R14  | \$169.99 |
| 705403081 - 27X9R14  | \$159.99 |
| 705503181 - 28X11R14 | \$174.99 |
| 705503355 - 27X11R14 | \$164.99 |
| 705402713 - 26X8R12  | \$169.99 |
| 705503073 - 26X10R12 | \$174.99 |

### XPS Trac Force



- All-terrain light truck style radial tire.
- 8-ply rated construction.
- Center tread for good grip and comfort on compact terrain.
- Tread depth: 18 mm (0.71").

|                      |          |
|----------------------|----------|
| 705403080 - 30X9R14  | \$259.99 |
| 705503354 - 30X10R14 | \$269.99 |
| 705403416 - 32X10R16 | \$279.99 |

### XPS Hammer Force



- Light truck-inspired tire.
- 8-ply rated construction.
- Rock-crawling tread pattern with unique contact patch.
- Aggressive sidewall for maximum traction when faced with technical terrain.
- Tread depth: 15 mm (0.59").

|                      |          |
|----------------------|----------|
| 705402918 - 30X10R15 | \$279.99 |
|----------------------|----------|

### XPS Swamp Force



- Hybrid radial tire for mud & trail.
- 8-ply rated construction.
- Unique tread pattern allowing good grip in mud and mud ejection.
- Center tread provides for comfortable trail riding.
- Tread depth: 36-38 mm (1.41"-1.49").

|                      |          |
|----------------------|----------|
| 705403201 - 30X9R14  | \$259.99 |
| 705503387 - 30X11R14 | \$279.99 |

### XPS Swamp King



- Bias tires for mud and trail.
- 6-ply rated construction.
- Ultimate performance in mud without sacrificing good trail handling.
- Tread depth: 38 mm (1.49").

|                      |          |
|----------------------|----------|
| 705403028 - 28X8X14  | \$189.99 |
| 705503324 - 28X10X14 | \$199.99 |

# DEFENDER TIRES & RIMS

## Tires

|   |  |   |          |
|---|--|---|----------|
| <b>ITP Cryptid</b>  | Defender X m r   | 705402504 · Front   | \$309.99 |
|   |  | 705502913 · Rear  | \$339.99 |
|  | <ul style="list-style-type: none"> <li>· Front: 30" x 9" x 14".</li> <li>· Rear: 30" x 11" x 14".</li> </ul> | <ul style="list-style-type: none"> <li>· Graduated lug height and paddle-like shoulder configuration provide maximum side bite for climbing in and out of the mud without compromising ride comfort on trails and hard pack.</li> <li>· 6-ply rated.</li> </ul> |          |

## Maxxis Bighorn 2.0 Tire

|   |                       |                        |          |
|---|-----------------------|------------------------|----------|
|  | Defender (XT, XT Cab) | 705402168 · Front      | \$269.99 |
|   |                       | 705400961 · (C) · Rear | \$269.99 |
|   | Defender              | 705502665 · Rear       | \$284.99 |
|   |                       | 705501295 · (C) · Rear | \$284.99 |
|   | Defender              | 705402560 · Front      | \$259.99 |
|   |                       | 705401386 · (C) · Rear | \$259.99 |
|   | Defender              | 705502938 · Rear       | \$279.99 |
|   |                       | 705501818 · (C) · Rear | \$279.99 |
|   |                       | 705402080 · Front      | \$289.99 |
|   |                       | 705502603 · Rear       | \$299.99 |

## Maxxis M 923J M 924J

|  |                                   |  |          |
|--|-----------------------------------|--|----------|
|  | Defender (Base & DPS models only) | 705402107 · Front  | \$169.99 |
|  |                                   | 705502626 · Rear   | \$174.99 |
|  |                                   | <ul style="list-style-type: none"> <li>· Front: 25" x 8" x 12".</li> <li>· Rear: 25" x 10" x 12".</li> </ul> |          |

## Rear Tire Chains

|   |  |  |         |
|---|--|--|---------|
|  |  | 715000225 · 29" x 9" x 14"   | \$93.99 |
|   |  |  |         |
|   |  | <ul style="list-style-type: none"> <li>· Improve your traction in mud and snow.</li> <li>· Sold in pairs.</li> </ul> |         |

## Rims

|  |                         |  |          |
|--|-------------------------|--|----------|
| <b>14" Rim</b><br><i>(Not illustrated)</i>   | Defender, Defender M AX | 705401594 · Front  | \$279.99 |
|  |                         | 705503191 · Rear   | \$229.99 |
|  |                         | <ul style="list-style-type: none"> <li>· Front: 14" x 6.5" offset = 41 mm.</li> <li>· Rear: 14" x 8" offset = 51 mm.</li> </ul>  |          |
|  |                         | <ul style="list-style-type: none"> <li>· Black with clear coat aluminum rim.</li> <li>· Choice of beadlock color (not included).</li> <li>· Needs 16 bolts (250000787) for installing the beadlock.</li> </ul> |          |
| <b>14" Beadlock Rings</b>  | Defender, Defender M AX | 705401586 · Manta Green  | \$83.99  |
|  |                         | 705401702 · Octane Blue  |          |
|  |                         | 705401837 · Can-Am Red   |          |
|  |                         | 705401840 · Black  |          |
|  |                         | <ul style="list-style-type: none"> <li>· Cast aluminum beadlock.</li> <li>· Must be installed on Front Rim (705401594) and Rear Rim (705503191).</li> </ul>  |          |
|  |                         | <ul style="list-style-type: none"> <li>Matching Nuts - 250100184</li> <li>Matching Cap - 705400928</li> </ul>  |          |

|   |                        |  |          |
|---|------------------------|--|----------|
| <b>12" Rim</b><br><i>(Not illustrated)</i>  | Defender, Defender MAX | ■ 705401678 · Black · Front  | \$244.99 |
|   |                        | ■ 705502244 · Black · Rear   | \$249.99 |
| <ul style="list-style-type: none"> <li>· Front: 12" x 6" offset = 41 mm .</li> <li>· Rear: 12" x 7.5" offset = 51 mm .</li> </ul> |                        | <ul style="list-style-type: none"> <li>· Black with clearcoat aluminum rim .</li> <li>· Choice of beadlock color (not included).</li> <li>· Needs 16 bolts (250000787) for installing the beadlock.</li> </ul> |          |

|                           |                        |                            |         |
|---------------------------|------------------------|----------------------------|---------|
| <b>12" Beadlock Rings</b> | Defender, Defender MAX | ■ 705401816 · Can-Am Red   | \$78.99 |
|                           |                        | ■ 705401815 · Orange Crush |         |
|                           |                        | ■ 705401814 · Yellow       |         |



- Cast aluminum beadlock.
- Must be installed on Front Rim (705401678) and Rear Rim (705502244).

Matching Nuts - 250100184  
Matching Cap - 705400928

|  |                                       |  |          |
|--|---------------------------------------|--|----------|
| <b>Outlander X mr and Defender Rim</b> | Defender, Defender MAX (front wheels) | ■ 705401848 · Black and machined · Front | \$194.99 |
|  |                                       | ■ 705502397 · Black and machined · Front | \$169.99 |
|  |                                       | ■ 705401849 · Black · Front              | \$204.99 |
|  |                                       | ■ 705502398 · Black · Rear               | \$199.99 |



- Cast aluminum rim with trendsetting explosive styling so you can ride and look like a trailblazer.
- Front: 14" x 6.5" offset = 10 mm .
- Rear: 14" x 8.5" offset = 23 mm .

Matching Nuts - 250100184 Black, 250100185 Chrome  
Matching Cap - 705401541

|                                       |                        |                             |          |
|---------------------------------------|------------------------|-----------------------------|----------|
| <b>Defender Cast-Aluminum 14" Rim</b> | Defender, Defender MAX | ■ 705402338 · Black · Front | \$229.99 |
|                                       |                        | ■ 705502778 · Black · Rear  | \$169.99 |



- Front: 14" x 7" offset = 41 mm .
- Rear: 14" x 8.5" offset = 51 mm .

Matching Nuts - 250100184  
Matching Cap - 705401541

|  |                        |                   |          |
|--|------------------------|-------------------|----------|
| <b>Lone Star Cast-Aluminum 14" Rim</b><br><i>(Not illustrated)</i> | Defender, Defender MAX | 705402334 · Front | \$169.99 |
|  |                        | 705502775 · Rear  | \$194.99 |

- Front: 14" x 7" offset = 41 mm .
- Rear: 14" x 8.5" offset = 51 mm .

Matching Nuts - 250100184  
Matching Cap - 705401541

|   |                        |   |          |
|---|------------------------|---|----------|
| <b>Defender Rim</b><br><i>(Not illustrated)</i> | Defender, Defender MAX | ■ 705402120 · Black · Front               | \$204.99 |
|   |                        | ■ 705502637 · Black · Rear                | \$194.99 |
|   |                        | ■ 705402118 · Silver and Machined · Front | \$169.99 |
|   |                        | ■ 705502634 · Silver and Machined · Rear  | \$194.99 |
|   |                        | ■ 705402121 · Black and Machined · Front  | \$169.99 |
|   |                        | ■ 705502635 · Black and Machined · Rear   | \$179.99 |

- Front: 14" x 7" offset = 41 mm .
- Rear: 14" x 8.5" offset = 51 mm .

Matching Nuts - 250100184 Black, 250100185 Chrome  
Matching Cap - 705401541



# COMMANDER, MAVERICK TRAIL & MAVERICK SPORT TIRES & RIMS

## Tires Commander

|                             |                           |                  |          |
|-----------------------------|---------------------------|------------------|----------|
| <b>Maxxis Coronado Tire</b> | Commander; CommanderM AX* | 705402058 -Front | \$279.99 |
|                             |                           | 705502576 -Rear  | \$299.99 |



- Front: 27" x 9" x 14".
  - Rear: 27" x 11" x 14".
  - Compliant with European class T regulations.
- #Except XT-P.

## Tires - Maverick Trail & Maverick Sport

|                                |                                    |                  |          |
|--------------------------------|------------------------------------|------------------|----------|
| <b>Maxxis Bighorn 2.0 Tire</b> | Maverick Sport; Maverick SportM AX | 705402560 -Front | \$259.99 |
|                                |                                    | 705502938 -Rear  | \$279.99 |



- Front: 27" x 9" x 12".
- Rear: 27" x 11" x 12".
- Compliant with European class T regulations.

|                            |                  |                  |          |
|----------------------------|------------------|------------------|----------|
| <b>Maxxis Liberty Tire</b> | Maverick SportXC | 705402563 -Front | \$339.99 |
|                            |                  | 705402143 -Rear  | \$369.99 |



- Engineered for performance driving and to give you and your side-by-side freedom in a variety of terrains.
- Exceeds DOT test standards.
- 8-ply radial construction.
- Specialized rubber compound for supreme traction and control.
- Excellent tread wear.
- Front: 28" x 10" x 14".
- Rear: 30" x 10" x 14".

|                          |                |                  |          |
|--------------------------|----------------|------------------|----------|
| <b>Carlisle ACT Tire</b> | Maverick Trail | 705402313 -Front | \$159.99 |
|                          |                | 705402314 -Rear  | \$169.99 |



- Front: 26" x 8" x 12".
- Rear: 26" x 9" x 12".

## Rims

|  |                                   |                  |          |
|--|-----------------------------------|------------------|----------|
| <b>12" Maverick Trail DPS/ Sport Rim</b> | Maverick TrailDPS; Maverick Sport | 705401417 -Front | \$179.99 |
|  | Maverick Sport                    | 705501853 -Rear  | \$194.99 |
|  | Maverick TrailDPS                 | 705401417 -Rear  | \$179.99 |



- Matching Nuts: 250100184 (Black).
- Matching Cap: 705400928.
- Maverick Sport: Front: 12" x 6" O offset = 41 mm / Rear: 12" x 7.5" O offset = 51 mm.
- Maverick TrailDPS: Front: 12" x 6" O offset = 41 mm / Rear: 12" x 6" O offset = 41 mm.

|  |                           |                   |          |
|--|---------------------------|-------------------|----------|
| <b>14" Maverick Sport X rc/ X mr Rim</b> | Maverick Sport X rc/ X mr | 705402338 · Front | \$229.99 |
|  | Maverick Sport X rc       | 705402338 · Rear  | \$229.99 |
|  | Maverick Sport X mr       | 705502778 · Rear  | \$169.99 |



- Maverick Sport X rc: Front ·14" x 7" Offset= 41 mm /Rear ·14" x 7" Offset= 41 mm .
- Maverick Sport X mr: Front ·14" x 7" Offset= 41 mm /Rear ·14" x 8.5" Offset= 51 mm .

|                               |                |           |          |
|-------------------------------|----------------|-----------|----------|
| <b>12" Maverick Trail Rim</b> | Maverick Trail | 705401217 | \$129.99 |
|-------------------------------|----------------|-----------|----------|



- Matching Nuts: 250100042 .
- 12" x 6" - Offset= 41 mm .

# MAVERICK X3 TIRES & RIMS

## Tires

|  |  |                         |          |
|--|--|-------------------------|----------|
| <b>Maxxis<sup>+</sup> Bighorn 2.0 Tire</b> |  | 705402080 · Front       | \$289.99 |
|  |  | 705502603 · Rear        | \$299.99 |
|  |  | 705402168 · Front · (C) | \$269.99 |
|  |  | 705502665 · Rear · (C)  | \$284.99 |



- Front ·28" x 9" x 14".
- Rear ·28" x 11" x 14".
- Compliant with European class T regulations.
- Front ·27" x 9" x 14".
- Rear ·27" x 11" x 14".

|                            |                  |                   |          |
|----------------------------|------------------|-------------------|----------|
| <b>Maxxis Liberty Tire</b> | Maverick X3 X rc | 705402143 · Front | \$369.99 |
|                            |                  | 705402464 · Rear  | \$389.99 |



- Engineered for performance driving and to give you and your site-by-site freedom in a variety of terrains.
- 8-ply radial construction.
- Front: 30" x 10" x 14".
- Rear: 32" x 10" x 15".

|                              |  |                 |          |
|------------------------------|--|-----------------|----------|
| <b>Maxxis Carnivore Tire</b> | Maverick X3 (except X mr X rc & X rc models) | 705402960 · 30" | \$369.99 |
|                              |  | 705402961 · 32" | \$409.99 |



- The Carnivore boasts a gnarly tread design that delivers excellent traction on rocks, roots, desert terrain, and mud. The Carnivore is designed to conquer a wide variety of terrains.
- Aggressive all-terrain tread pattern.
- 8-ply-rated radial construction.
- Front & Rear ·30" or 32" x 10" x 14".

|  |  |                   |          |
|--|--|-------------------|----------|
| <b>Maxxis Bighorn X ds Tire</b><br>(Not illustrated) |  | 705402081 · Front | \$309.99 |
|  |  | 705502604 · Rear  | \$319.99 |

- Front ·29" x 9" x 14".
- Rear ·29" x 11" x 14".

|  |  |           |          |
|--|--|-----------|----------|
| <b>Maxxis Bighorn X rs Tire</b><br>(Not illustrated) |  | 705402082 | \$339.99 |
|--|--|-----------|----------|

- Front & Rear ·30" x 10" x 14".

## Rims

### 14" Maverick X3 X mr Rim

M averick X3, M averick X3 M AX

705402256

\$234.99



- Black with clearcoat aluminum rim .

### 14" Maverick X3 Beadlock Rim

M averick X3, M averick X3 M AX

■ 705402207

· Black and machined

\$234.99

■ 705402173 · Black

\$244.99



- Black aluminum rim with machined face and clearcoat.
- Choice of beadlock color (not included).
- Needs 16 bolts (250000893) for installing the beadlock.

### 14" Maverick X3 Rim

M averick X3, M averick X3 M AX

705401965 · Front

\$134.99

705502493 · Rear

\$134.99



- Black with clearcoat aluminum rim .
- Front: 14" x 7" O offset = 55 mm .
- Rear: 14" x 8" O offset = 76 mm .

### 14" Maverick X3 Beadlock Rim

M averick X3, M averick X3 M AX

705402393 · Front

\$224.99

705502814 · Rear

\$239.99



- Black with clearcoat aluminum rim .
- Choice of beadlock color.
- Needs 16 bolts (250000893) for installing the beadlock.
- Front: 14" x 7" O offset = 55 mm (For X 3s = Front and Rear).
- Rear: 14" x 8" O offset = 76 mm .

### 14" Maverick X3 Beadlock Ring

M averick X3 & M averick X3 M AX (X 3s, X 3ds models only)

■ 705401709 · Black

\$83.99

■ 705401913 · Gold

\$83.99

■ 705402358 · Can-Am Red

\$75.99

■ 705402472 · Manta Green

\$90.99



- Cast aluminum beadlock.
- Must be installed on Front Rim (705402393) and Rear Rim (705502814).

# LUBRICANT & OIL CHANGE KIT

## Lubricant

### XPS 4T 10W-50 Synthetic Oil

9779234 · 1 qt / 946 ml

9779235 · 1 US gal / 3.785 L



- Engineered for heavy-duty and high-performance 4-stroke engines, including turbocharged, supercharged and racing engines.
- Formulated using carefully selected and strenuously tested base stocks and custom additives.
- Offers thick film strength to protect bearings, and a proven high-temp detergency to minimize deposits, prevent shear, provide thermal stability, and combat field dilution to ensure maximum performance from your engine.

### XPS 4T 0W-40 Synthetic Oil

9779139 · 1 qt / 946 ml

9779140 · 1 US gal / 3.785 L



- Powersports formula with premium antiwear and anti-corrosion additives.
- The best choice for high-performance snowmobile, ATV and SXS 4-stroke engines used in cold weather.
- Provides superior engine and transmission protection against heat, rust and corrosion.
- Delivers optimal performance in high and low temperatures.

### XPS 4T 5W-40 Synthetic Blend Oil

9779133 · 1 qt / 946 ml

9779134 · 1 US gal / 3.785 L



- Off-road formula with premium antiwear and anti-corrosion additives.
- Designed for high-performance off-road, on-road and PWC 4-stroke engines, including turbo or supercharged powersports engines.
- Provides superior engine and transmission protection against rust and corrosion, even in extreme conditions.

## Oil Change Kit

### Engine Oil Change Kit



- Ultra-convenient "all-in-one" Engine Oil Change Kit saves time and money.
- Includes XPS Synthetic or Synthetic Blend Oil, oil filter, O-rings and washer.

### Models

|  |         |
|--|---------|
| 5W-40 Synthetic Blend Oil / 450 cc or less               | 9779256 |
| 0W-40 Synthetic Oil / 450 cc or less                     | 9779257 |
| 5W-40 Synthetic Blend Oil / 500 cc or more V-twin engine | 9779258 |
| 0W-40 Synthetic Oil / 500 cc or more V-twin engine       | 9779259 |
| 10W-50 Synthetic Oil / 500 cc or more V-twin engine      | 9779252 |
| 0W-40 Synthetic Oil / 650 ACE                            | 9779481 |
| 5W-40 Synthetic Blend Oil / 900 ACE                      | 9779260 |
| 10W-50 Synthetic Oil / 900 ACE                           | 9779261 |



# MAINTENANCE PRODUCTS

## Synthetic Gear Oil

75W -90

9779158 · 1 qt / 946 m l

75W -140

9779160 · 1 qt / 946 m l



- Uses custom additives to provide the best performance in Visco-Lok™ and Smart-Lok™ differentials.
- Allows higher loads, superior shear stability and reduced oxidation.
- Exceptional wear protection and superior performance at all operating temperatures.

## XPS Synthetic Dct Fluid

(Not illustrated)

9779710 · 1 qt / 946 m l

- Meets or exceeds API GL-4 industry specifications.
- Formulated for dual clutch system.
- Enhanced cooling capabilities for optimal clutch functionality.
- Anti-foaming agents for smooth hydraulic function.

## Extended Life Pre-Mixed Coolant

9779150 · 1 qt / 946 m l



- Antifreeze/coolant contains the correct dilution and the necessary additives to prevent corrosion and inhibit cavitation in BRP cooling systems.
- Long-life, 5-year formula specially formulated for BRP vehicles.
- Superior heat transfer.
- Real replacement for vehicles that normally use a 2-year antifreeze/coolant (green).
- 5 years (orange).

## Anti-Corrosive Lubricant

9779166 · US 12 oz / 340 g

9779167 · CDN 12 oz / 340 g



- Multipurpose lubricant that can also be used to prevent rust, corrosion and moisture intrusion.
- It contains extreme pressure additives that work as an all-around lubricant for just about anywhere lubrication is needed.

## Extreme Duty Suspension Grease

(Not illustrated)

9779708 · 14 oz / 400 g

- Designed to work specifically with the components found in Can-Am vehicle suspensions.
- It is highly stable and offers optimal lubrication at both extreme cold and high temperatures while protecting suspension components from dirt and moisture, as well as corrosion under extreme washout conditions.

## XPS Spline Grease

(Not illustrated)

9779704 · 4 oz / 115 g

- Enhanced rust and corrosion resistance.
- Protects against seizure, heat-freeze, galling, rust and corrosion.

## DOT 4 Brake Fluid

9779151 · 12 fl.oz. / 355 m l



- Meets or exceeds all DOT 3 and DOT 4 brake fluid requirements.
- High-temperature formula resists fade and also conditions seals and O-rings in braking system.



# HOW TO USE XPS CARE PRODUCTS

# 1

## Spray the All Purpose Cleaner & Degreaser

product directly on dirt and grime, leave for 30 seconds, then rub lightly with a clean microfiber cloth, wet cleaning mitt or a soft brush. Rinse immediately with plenty of water.

Ø779328 – 22 fl.oz. / 650 ml, Ø779329 – 2 qt. / 1.89 L)



# 2

## Spray the Mud & Dust Wash

product directly on the surface, leave on for 3 or 4 minutes, then rinse thoroughly with water. If tough stain persists, spray the product again and scrub with a clean microfiber cloth, wet cleaning mitt or soft brush and rinse again.

Ø779340 – 33 fl.oz. / 946 ml, Ø779341 – 2 qt. / 1.89 L)



# 3

## Mix the Foaming Wash

product. Mix 30 ml (1 oz) of cleaner for every 4 L (1 gallon) of water used. Foam cannon or gun work best for larger vehicles. Wash with a clean mitt or soft brush and rinse thoroughly with water.

Ø779337 – 16 fl.oz. / 473 ml, Ø779338 – 2 qt. / 1.89 L)



# 4

## Pour Black Plastic & Rubber Restorer

product on wax applicator pad or clean cloth and apply evenly over surfaces that need to be treated. Keep away from water for a 24-hour period to allow product to dry.

Ø779335 – 7.6 fl.oz. / 225 ml)



# 5

## Spray Multi-Surface & Glass Cleaner

product directly on surface and wipe off excess with a clean, soft cloth until the light haze disappears.

Ø779331 – 22 fl.oz. / 650 ml)



## Racing Brake Fluid RS600

9779152 · 12 fl.oz./355 m l



- Exceeds DOT 4 brake fluid requirements for extreme conditions and competition use.
- Extreme, 579-degree boiling point temperature is ideal for high-demand and competition conditions to combat brake fade.
- Will not harm seals or braking system components.
- Should be added only to a clean/unfilled system to avoid dilution and diminished performance.
- Low moisture formula slows water vapor absorption through multiple heat cycles.
- Recommended for use in SkiDoo and Can-Am racing applications.

## Fuel Stabilizer

9779171 · 8 fl.oz./236 m l



- Ethanol-compatible and will stabilize fuel in your tank to keep it from breaking down and causing hard starting, throttle hesitation and poor run quality.
- Since ethanol attracts moisture, this product contains powerful anti-combustion additives to protect fuel system components.
- Prevents problems associated with E10 fuels.

# CARE PRODUCTS

## Cleaner and Degreaser, All Purpose

9779328 · 22 fl.oz./650 m l

9779329 · 2 qt./1.89 L



- Ready-to-use formula.
- Cleans toughest dirt and grime.
- Phosphate free eco-friendly formula.
- Low-foam easy rinse formula.

## Matte Finish Waterless Cleaner

9779330 · 22 fl.oz./650 m l



- Easy waterless use.
- Perfect for matte, flat and denim surfaces.
- Contains no wax or silicone.
- Leaves no unwanted streaks or marks.

## Multi-Surface and Glass Cleaner

9779331 · 22 fl.oz./650 m l



- Easy waterless spray and wipe use.
- Polymer formula cleans and protects.
- Contains no wax or silicone.
- Leaves no unwanted streaks or marks.

## Mud and Dust Off-Road Wash

9779340 · 33 fl.oz./946 m l

9779341 · 2 qt./1.89 L



- Specially formulated for off-road vehicles, it breaks the bond holding grime and dirt to your vehicle's finish.
- The formula is biodegradable, eco-friendly with no phosphates or corrosive chemicals and is low foam for easy, quick rinsing.
- Effective on oil, grease and other stubborn grime.
- Safe for use on all surfaces.

## Black Plastic and Rubber Restorer

9779335 · 7.6 fl.oz. / 225 ml



- Restores plastic, rubber and vinyl.
- Long-lasting formula.
- Protects against UV rays.

## Foaming Wash

9779337 · 16 fl.oz. / 473 ml

9779338 · 2 qt / 1.89 L



- Concentrated formula for off-road vehicles, it produces a thick foam to lift dirt and prevent scratching.
- The pH neutral formula is safe for wax and paint sealants.
- Works in pressure washers or by hand.

## Quick Detailer Gloss Enhancing

9779332 · 4 fl.oz. / 118 ml

9779333 · 16 fl.oz. / 473 ml



- Quick detail spray wax.
- Leaves a high gloss finish at every wipe.
- Nanotechnology polymer formula.
- Repels dirt.
- No water needed.





# BRP REIMAGINES THE WAY YOU ACCESS YOUR WORLD

Can-Am is one of many success stories from BRP, the global company behind some of the most daringly innovative products and experiences that move you. Because it's not about the destination, it's about the journey — yours.

Discover our brands:

*ski-doo* **LYNX** **SEA-DOO** *can-am* **ROTAX** **ALUMACraft** **MANITOU** **QUINTREX**

[www.brp.com](http://www.brp.com)







CANAMOFFROAD.COM

M Y24 716001901

