



STERNDRIVES & INBOARDS

# MERCURY MERCUISER®



# THERE ARE PLACES TO GO. THINGS TO DISCOVER. PEOPLE TO SPLASH.

---

Days off work are best spent on the water. Messy hair, sand-covered feet and smiles so bright you need to up your SPF. Someday you'll catch yourself daydreaming about the good old days and start to smell sunscreen. Work can wait. Your only job today is making memories worth remembering.



01  
MERCURY MERCUISER

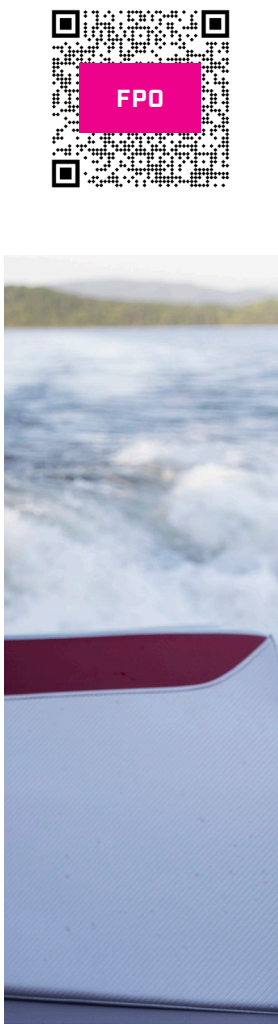

# EVERYTHING WE DO BEST. FOR EVERYTHING YOU DO BEST.

More than 50 years of constant innovation, testing, refining and reengineering are built into every Mercury® MerCruiser® engine. It's what we obsess about. And it's what you should never even think about.

MerCruiser sterndrives, inboards and tow sport engines keep the focus on fun. With models ranging from 200 to 430hp, MerCruiser engines are designed to power your days on the water without overwhelming them. They're smooth, quiet, fun to drive, simple to maintain and loaded with convenient SmartCraft® tech features.

So go fast. Go far. Go float. Whatever you do, go have fun.



**04**  
MERCURY MERCUISER



STERNDRIVES

# FUN FROM START TO FINISH

You were born to have fun on the water, and so was a MerCruiser sterndrive engine.

Designed specifically for marine use rather than derived from automotive engine technology, MerCruiser sterndrive engines are purpose-built for unmatched performance and ease of operation. Fun follows function. All by design.



6.2L STERNDRIVE

300/350 HORSEPOWER V8 ENGINE

8.2L STERNDRIVE

380/430 HORSEPOWER V8 ENGINE

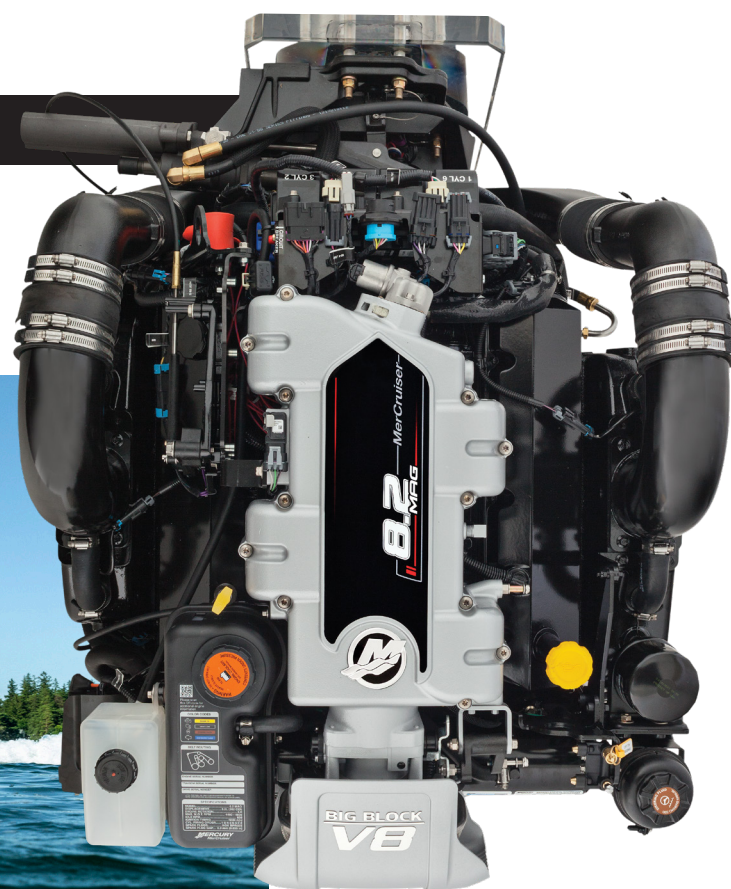

4.5L STERNDRIVE

200/250 HORSEPOWER V6 ENGINE





INBOARDS

## FOLLOW THE FUN

MerCruiser inboard engines continue Mercury's legacy of delivering power and efficiency. Each model features added displacement and a torque curve designed to maximize your fuel, your time and your fun. It's never been so easy to create unforgettable moments on the water.

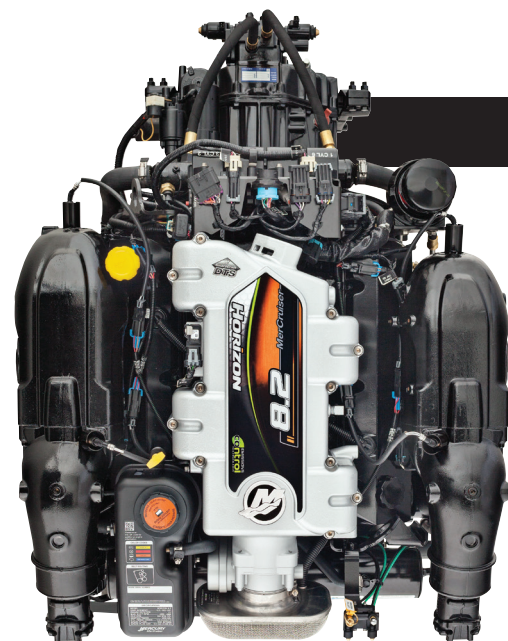

**8.2L INBOARD**  
**375/425**  
 HORSEPOWER **V8**  
 ENGINE



**6.2L INBOARD**  
**300/350**  
 HORSEPOWER **V8**  
 ENGINE



TOW SPORT INBOARDS

## POWER THAT PLAYS

If your destination is adrenaline, a MerCruiser tow sport inboard will take you there. Designed for high-action watersports, our tow sport inboards deliver effortless torque and precise speed control for peak performance, whether you're in the captain's chair or skimming above the prop wash.



**6.2L TOW SPORT INBOARD**  
**320/370** **V8**  
 HORSEPOWER ENGINE

**6.2L JET READY INBOARD**

**370** **V8**  
 HORSEPOWER ENGINE

Power, performance and durability, made for the places other engines can't go. A Mercury Jet Ready Inboard provides dependable power to drive-line applications on rugged boats and in shallow, unpredictable water.



DRIVES

# CHOOSE YOUR CRUISE

Whether an ideal day means towing family and friends, aimlessly joyriding or dropping the hammer, MerCruiser offers the drive to fit your needs. Our drives own a hard-earned reputation for outstanding power, handling and efficiency across a wide spectrum of applications.

## ALPHA ONE

Featuring a sleek, hydrodynamic profile, the Alpha One® drive is a staple in the sterndrive market. Time-tested by countless afternoons on the water, its fluid handling and fuel-efficient design have earned it a reputation for reliability.



## BRAVO ONE, ONE X AND ONE XR

Built to go big, the Bravo One® drive series is designed to make the most of big-block engine power. A longer torpedo shape and deeper skeg deliver confident control at all speeds, while dual water pickups ensure big engines keep their cool at high speeds.

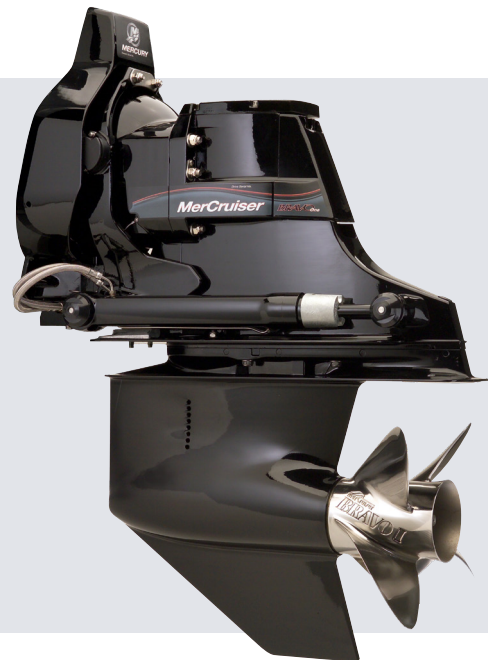

## BRAVO TWO, TWO X AND TWO XR

Designed to handle the heavyweights, our Bravo Two® series provides thrust and control by swinging props up to 20 inches in diameter, ideal for applications such as houseboats and the heaviest cruisers. The Bravo Two series gets heavy boats on plane with ease and saves fuel by maintaining plane at lower cruising speeds.



## BRAVO THREE, THREE X AND THREE XR

The Bravo Three® series delivers superior handling by canceling out prop torque through contra-rotating props. Bravo Three drives can be outfitted with props up to 16 inches in diameter, allowing for larger blades that grab more water for increased control, whether at wide-open throttle or maneuvering in tight spaces.



## BRAVO FOUR S

The Bravo Four S® forward-facing drive features contra-rotating props that grip undisturbed water to enhance maneuverability – even at lower tow sport speeds. Integrated with SmartCraft® digital features, the Bravo Four S drive is the ultimate solution for wakesurfing and other tow sports. Digital controls make it simple to manipulate the ballast, speed and surf tabs to carve out the perfect wake, while industry-exclusive launch intensity presets can be tailored to any rider's skill level and preference.



10  
MERCURY MERCUISER

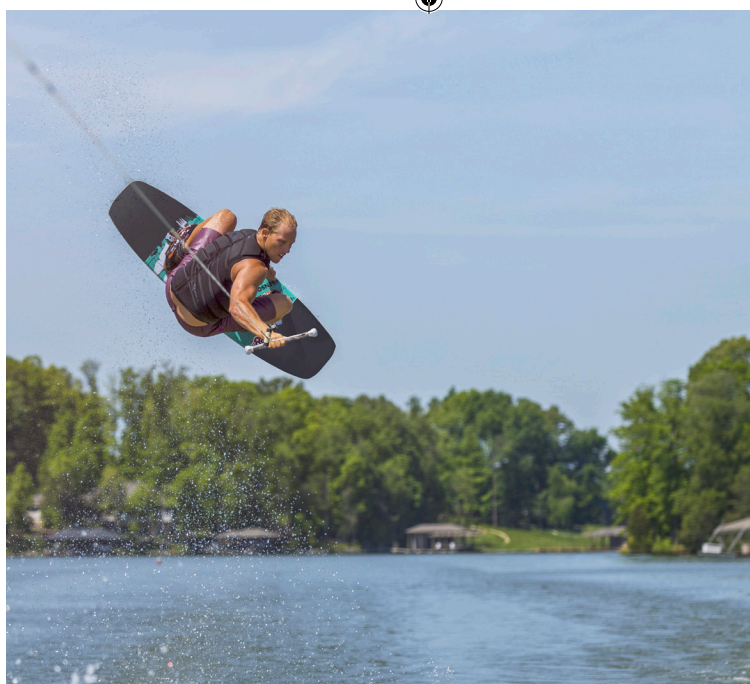

# THE MERCUISER ADVANTAGE

## NOISE REDUCTION HEAR HERE

Hear your friends and family talk. Hear yourself think. Enjoy your time on the water. Mercury has invested heavily in new sound-dampening advancements, such as aft-facing throttle bodies, lower-rpm performance and redesigned engine mounts. A MerCruiser engine is still as powerful as ever. It's just not so loud about it.

## PERFORMANCE FUN FOLLOWS FUNCTION

Featuring large displacement and a multi-port fuel-injection system, MerCruiser engines maximize the power from every drop of fuel. Enhanced air flow improves low- and mid-range torque, delivering instantly responsive power. Enabling Adaptive Speed Control will maintain an rpm setting, increasing comfort and efficiency by automatically accounting for changes in load weight or water conditions.

## EFFORTLESS OWNERSHIP MAINTENANCE MADE EASY

Our redesigned engine access has simplified what was once a hassle, bringing all service points to a single easily reachable location, color-coded for owner-friendly maintenance. An industry exclusive, the valve train is also maintenance-free for the life of your engine.

## DURABILITY ENGINES THAT GO THE EXTRA MILE

Through grueling endurance test cycles – in the lab and on the water – Mercury has refined every MerCruiser engine into an unflinching workhorse, built with better alloys and superior paints that can stand up to the harshest conditions.





# THE POWER TO DO MORE

Learn more at [mercurymarine.com/smartcraft](http://mercurymarine.com/smartcraft).



## VESSELVIEW EVERY ENGINE HAS A STORY TO TELL

VesselView® brings your engine's stats and digital controls to your fingertips. For convenient access, VesselView Mobile® displays real-time engine data on mobile devices. VesselView Link and SmartCraft® Connect integrate performance data onto existing displays from Lowrance®, Simrad®, Garmin® and Raymarine®.

## SMARTCRAFT DIGITAL FEATURES EASIER EVERYTHING

Smart Tow® takes the guesswork out of tow sports with the touch of a button, launching skiers, tubers and wakeboarders at their preferred speed. Digital surf controls coordinate ballast, surf tabs and propulsion settings, ensuring the perfect perpetual wave. Active Trim automatically adjusts to optimize trim levels, adapting on the fly for smooth, efficient trips.



## DIGITAL THROTTLE & SHIFT SMOOTH AT ANY SPEED

Digital Throttle & Shift (DTS) controls deliver silky-smooth shifting and instant throttle response, for a premium driving experience.

## JOYSTICK PILOTING 360° CONTROL

Available Joystick Piloting for Inboards and Joystick Piloting for Sterndrives make maneuvering in tight quarters easier than ever before. We offer the only fully integrated joystick control available for tow sport boats, ensuring agile handling around the dock and trailer, as well as safe, easy pickups of dropped skiers and boarders.





PROPELLERS

# WHERE THE RPMs MEET THE H<sub>2</sub>O

Mercury propellers are engineered to convert every bit of MerCruiser horsepower into unmatched performance. With innovative technology and superior materials behind them, Mercury props set the standard for premium design and durability.

Find the ideal prop for your MerCruiser engine and drive at [mercurymarine.com/propselector](http://mercurymarine.com/propselector).

## BRAVO FOUR S DUAL CONTRA-ROTATING PROPS

Forward thinking. By moving dual contra-rotating props ahead of the gearcase, the Bravo Four S<sup>®</sup> drive grips undisturbed water, improving handling and efficiency. It makes creating the ideal wake for tow sports easier and better than ever. So the only thing you need to focus on is the fun.



## EXCLUSIVE METAL

Meet the material made specifically to propel Mercury engines. X7<sup>®</sup> stainless steel alloy is 4x more durable and 30% stronger than conventional stainless, allowing Mercury to design props that would otherwise be impossible.

## HUB KITS

Mercury hub kits reduce noise, vibration and harshness at the source. They provide a cushion between the prop and the prop shaft, enhancing durability and protecting the drivetrain from most accidental prop impacts.

## PVS

Mercury props don't take anything for granted. Our exclusive Performance Vent System<sup>®</sup> (PVS) lets you custom-tune propeller venting, ensuring optimal acceleration.



SERVICE & MAINTENANCE

# FEWER WORRIES, MORE TIME ON THE WATER

Learn more at [mercurymarine.com/find-a-dealer](http://mercurymarine.com/find-a-dealer).



## WARRANTY

MerCruiser engines and drives include peace of mind from a factory-backed limited warranty of up to three years and a corrosion warranty of up to four years, depending on the model, installation and available features.



## MERCURY PRODUCT PROTECTION

A factory-backed extended service contract, Mercury Product Protection<sup>®</sup> covers certain expenses beyond the term of a Mercury limited warranty.



## DEALER NETWORK

If your engine requires service, an extensive network of factory-trained dealers and master technicians is ready with genuine Mercury replacement parts and accessories to get you back on the water.



## PRECISION CARE

Mercury Precision Parts<sup>®</sup> provide original factory fit and performance to help keep your engine running like new and performing at its peak. Mercury Precision Lubricants<sup>®</sup> are specially formulated and tested to exceed our high standards and keep engines running smoothly, no matter where your days take you.

# MERCUISER SPECIFICATIONS

## STERNDRIVES

	<b>4.5L / 4.5L H.O.</b> (275 cu in)	<b>6.2L</b> (377 cu in)	<b>8.2L MAG / 8.2L MAG H.O.</b> (502 cu in)
<b>Displacement</b>			
<b>HP</b>	200 / 250	300 / 350	380 / 430
<b>kW</b>	149 / 186	224 / 261	283 / 321
<b>Cylinders:</b>	V6	V8	V8
<b>WOT RPM:</b>	4400-4800 / 4800-5200	5000-5400	4600-5000 / 4600-5000
<b>Emission Control Technology (ECT):</b>	Yes*	Yes*	Yes*
<b>Fuel Injection:</b>	Multi-point electronic fuel injection (MPI)	Multi-point electronic fuel injection (MPI)	Multi-point electronic fuel injection (MPI)
<b>Fuel Compatibility:</b>	87 octane minimum / up to 10% ethanol	87 octane minimum / up to 10% ethanol	87 octane minimum / up to 10% ethanol
<b>Cooling System:</b>	Raw water**	Raw water**	Fresh water
<b>Engine Weight<sup>†</sup>:</b>	761lbs (345kg)	882lbs (400kg)	1122lbs (504kg)
<b>Engine Guardian:</b>	Yes	Yes	Yes
<b>Digital Throttle &amp; Shift (DTS):</b>	N/A / Optional	Optional	Optional

## INBOARDS

	<b>6.2L</b> (377 cu in)	<b>8.2L Horizon / 8.2L H.O.</b> (502 cu in)	<b>6.2L</b> (377 cu in)	<b>6.2L / 6.2L H.O.</b> (377 cu in)
<b>Displacement</b>				
<b>HP</b>	300 / 350	375 / 425	370	320 / 370
<b>kW</b>	224 / 261	280 / 317	276	239 / 276
<b>Cylinders:</b>	V8	V8	V8	V8
<b>WOT RPM:</b>	5000-5400	4200-4600 / 4400-4800	4000-5400	4000-5400 / 5000-5400
<b>Emission Control Technology (ECT):</b>	Yes*	Yes*	Yes*	Yes*
<b>Fuel Injection:</b>	Multi-point electronic fuel injection (MPI)	Multi-point electronic fuel injection (MPI)	Multi-point electronic fuel injection (MPI)	Multi-point electronic fuel injection (MPI)
<b>Fuel Compatibility:</b>	87 octane minimum / up to 10% ethanol	87 octane minimum / up to 10% ethanol	87 octane minimum / up to 10% ethanol	87 octane minimum / up to 10% ethanol
<b>Cooling System:</b>	Fresh water	Fresh water	Fresh water	Raw water**
<b>Engine Weight<sup>†</sup>:</b>	947lbs (420kg)	1122lbs (509kg)	935lbs (424kg)	862lbs (391kg)
<b>Engine Guardian:</b>	Yes	Yes	Yes	Yes
<b>Digital Throttle &amp; Shift (DTS):</b>	Standard	Standard	N/A	Optional

## JET READY

## TOW SPORT INBOARDS

\*Non-catalyzed models available for select international markets. Consult your local dealer for availability.

\*\*Optional freshwater cooling. Fresh water cooling standard on Bravo SeaCore® System.

†Weight of engine without drive or propeller.

Note: Due to our constant efforts to offer the finest products available, we reserve the right to change specifications without notice. Visit MercuryMarine.com or your Mercury Authorized Dealer for more engine specs and test results.

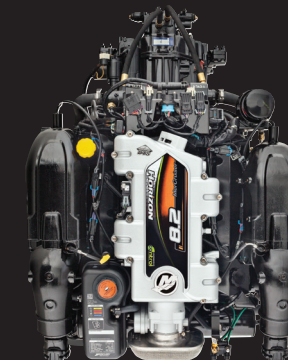
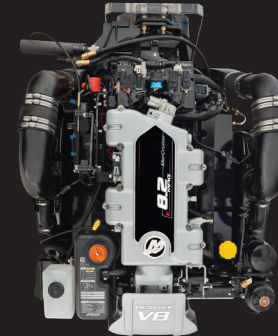
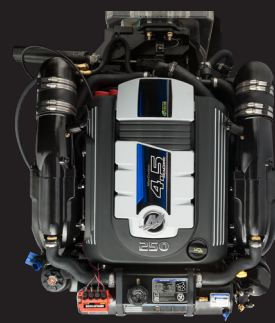



**MERCURY**  
**GO BOLDLY.®**

© 2022 Mercury Marine. All Rights Reserved. Reproduction in whole or in part without permission is prohibited.

GARMIN is a registered trademark of Garmin Ltd. LOWRANCE is a registered trademark of Navico Holding AS Corporation. RAYMARINE is a registered trademark of Teledyne FLIR, LLC. SIMRAD is a registered trademark of Kongsberg Maritime AS Company. All other trademarks belong to Brunswick Corporation.

Product information in this brochure is accurate as of April 2022. For the latest content, please visit [MercuryMarine.com](https://www.MercuryMarine.com)